

CMC 356

Technical Data



Manual version: ENU 1014 05 01

© OMICRON electronics GmbH 2022. All rights reserved.

These technical data were extracted from the *CMC 356* manual ENU 1014 05 01.

This manual is a publication of OMICRON electronics GmbH. All rights including translation reserved. Reproduction of any kind, for example, photocopying, microfilming, optical character recognition and/or storage in electronic data processing systems, requires the explicit consent of OMICRON. Reprinting, wholly or in part, is not permitted.

The product information, specifications, and technical data embodied in this manual represent the technical status at the time of writing and are subject to change without prior notice.

We have done our best to ensure that the information given in this manual is useful, accurate and entirely reliable. However, OMICRON does not assume responsibility for any inaccuracies which may be present. The user is responsible for every application that makes use of an OMICRON product.

OMICRON translates this manual from the source language English into a number of other languages. Any translation of this manual is done for local requirements, and in the event of a dispute between the English and a non-English version, the English version of this manual shall govern.

1 Technical data

1.1 Calibration and guaranteed values

We recommend that you send in your test sets for calibration at least once a year.

The drift of test equipment, that is, the deterioration of accuracy over time, depends strongly on environmental conditions and the application field. Excessive use or mechanical and/or thermal stress may result in the need for shorter calibration intervals.

Moderate working environments, on the other hand, allow you to increase the calibration interval to once every 2 or even 3 years.

- ▶ Particularly in cases of extended calibration intervals, verify the accuracy of the test set by cross-referencing the measurement results with traceable reference equipment either on a regular basis or prior to use. You can, for example, use a typical, often-used device under test as a reference, or use measurement equipment with a certified high accuracy.

Should the test equipment fail, immediately contact OMICRON Support for calibration or repair. Do not try to use it anymore.

Guaranteed values

- The values apply at $23\text{ °C} \pm 5\text{ °C}$ ($73\text{ °F} \pm 9\text{ °F}$), and after a warm-up time greater than 25 minutes.
- Guaranteed values of the generator outputs:
The values are valid in the frequency range from 10 to 100 Hz unless specified otherwise. Given maximum phase errors relate to the voltage amplifier outputs.
- Accuracy data for analog outputs are valid in the frequency range from 0 to 100 Hz unless specified otherwise.
- The given input/output accuracy values relate to the range limit value (% of range limit value).

1.2 Main power supply

Main power supply	
Connection	C14 connector according to IEC 60320-1
Voltage, single phase	
Nominal voltage	100 ... 240 V _{AC}
Operational range	85 ... 264 V _{AC}
Power fuse	T 12.5 AH 250 V (5 × 20 mm) Schurter ordering number 0001.2515 For more information, visit the website www.schurter.com .
Nominal supply current	Max. 12 A @ 110 V; max. 10 A @ 230 V
Frequency	
Nominal frequency	50/60 Hz
Operational range	45 ... 65 Hz
Overvoltage category	II

1.2.1 Operational limits in conjunction with a weak power supply input voltage

In general, the maximum output power of the *CMC 356* is limited by the power supply input voltage. If the power supply input voltage is less than 120 V_{AC}, it is possible to supply the *CMC 356* with 2 phases (L-L, for example with a NEMA 6 240 V U.S. Standard) instead of the normal phase-neutral (L-N) operation in order to increase the power supply input voltage.

In order to limit the internal losses and to maximize the output power of the voltage amplifier, always set the maximum test object voltage to the minimum value possible for the test.

Apart from the reduction of the available total output power, a weak power supply input does not further affect the technical data of the *CMC 356*.

Typical total output power at different power supply voltages

Power supply	Current	Typical total output power		
		Currents only	Currents	AUX DC and voltage
230 V	6 × 15 A	1600 W	1190 W	+300 W
	6 × 25 A	1470 W	1060 W	+300 W
	6 × 32 A	1320 W	910 W	+300 W
115 V ¹	6 × 15 A	1120 W	710 W	+300 W
	6 × 25 A	990 W	580 W	+300 W
	6 × 32 A	860 W	450 W	+300 W
100 V ¹	6 × 15 A	910 W	500 W	+300 W
	6 × 25 A	790 W	380 W	+300 W
	6 × 32 A	670 W	260 W	+300 W

1. After 15 min of continuous operation at full output power, a duty cycle of 15 min on/15 min off is required at an ambient temperature of 25 °C. This does not apply to the 6 × 32 A example because the output duration is limited by the current amplifier (→ section 1.5.3 "Current outputs" on page 9 for more details).

1.3 System clock accuracy

All signals generated or measured by the CMC 356 refer to a common internal time base that is specified as follows:

Characteristic	Specification
Clock performance	Stratum 3 (ANSI/T1.101-1987)
Frequency drift (over time)	
24 hours	<±0.37 ppm (±0.000037 %)
20 years	<±4.60 ppm (±0.00046 %)
Frequency drift (over temperature range)	<±0.28 ppm (±0.000028 %)

1.4 Synchronization

Synchronization of system clock

By synchronizing the system clock to an external time base, the system clock accuracy can be improved up to the level of the external time base. Synchronizing the system clock additionally makes the absolute time available in the system. The absolute time is used to tag measurement results, start distributed tests at the same time, and generate and measure synchrophasors.

The following specifications refer to the internal time base. For the absolute time accuracy of the outputs and inputs, the inherent error of the respective channel itself has to be added.

Characteristic	Specification
IEEE 1588-2008 (v2) Offset (UTC) Pulling range Supported profiles Supported sources	Error $<\pm 1 \mu\text{s}$ $\pm 100 \text{ ppm } (\pm 0.01 \%)$ IEEE C37.238-2011 (Power Profile: v1) IEEE C37.238-2017 (Power Profile: v2) IEC/IEEE 61850-9-3-2016: Communication Networks and Systems for Power Utility Automation – Part 9-3: Precision Time Protocol Profile for Power Utility Automation (Utility Profile) OMICRON <i>CMGPS 588</i> , <i>OTMC 100</i> or any Precision Time Protocol source (PTP grandmaster clock)
IRIG-B Offset (UTC) Pulling range Supported sources	Error $<\pm 1 \mu\text{s}$ $\pm 100 \text{ ppm } (\pm 0.01 \%)$ Third-party IRIG-B sources with OMICRON <i>CMIRIG-B</i> accessory

Absolute time synchronization

The voltage and current outputs can be synchronized to an absolute time base like IRIG-B and IEEE 1588 to generate output signals synchronous to the time source. This can be used to test phasor measurement units (PMU) by generating reference signals.

Absolute timing accuracy ¹		
	Typical	Guaranteed
Voltage output	Error $<\pm 1 \mu\text{s}$	Error $<\pm 5 \mu\text{s}$
Current output	Error $<\pm 5 \mu\text{s}$	Error $<\pm 20 \mu\text{s}$

1. Valid for a phasor with a frequency of 50/60 Hz

Synchronization to external analog signal

The phase and frequency of the voltage and current outputs can be synchronized to a reference input signal of 10 ... 300 V / 15 ... 70 Hz applied to binary input 10. In contrast to the synchronization of the system clock, this kind of synchronization influences the frequency and phase of the signal generation directly.

The possible accuracy depends on the quality of the synchronization signal because the synchronization uses the zero crossings of the signal.

1.5 Outputs

1.5.1 General generator outputs

General generator outputs data (analog current and voltage outputs, and LL out outputs)	
Frequency ranges	→ section 1.5.3 "Current outputs" on page 9. → section 1.5.4 "Voltage outputs" on page 12. → section 1.5.5 "Low-level outputs LL out for external amplifiers" on page 13.
Frequency resolution (signal generation)	<5 μHz
Bandwidth (-3 dB)	3.1 kHz
Phase range φ	-360° ... +360°
Phase resolution	0.001°
Phase error	→ section 1.5.3 "Current outputs" on page 9. → section 1.5.4 "Voltage outputs" on page 12. → section 1.5.5 "Low-level outputs LL out for external amplifiers" on page 13.
Amplitude temperature drift	0.0025 %/°C

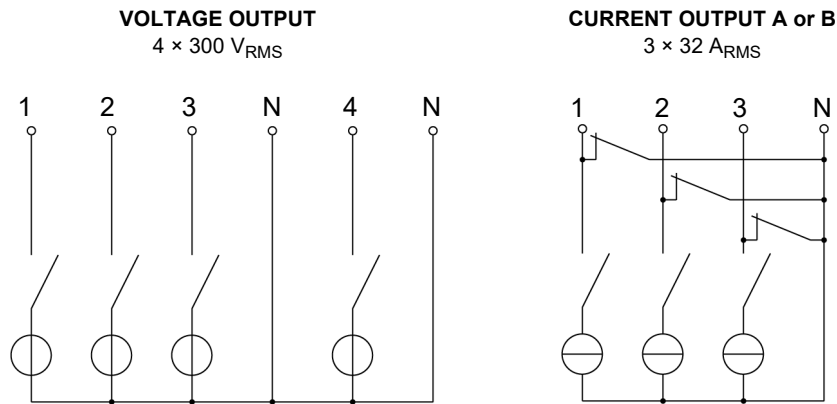

All voltages and current generators can independently be configured with respect to amplitude, phase angle, and frequency.

All outputs are monitored. Overload conditions prompt a notification in the control software.

1.5.2 Extended frequency range

In selected *Test Universe* modules, the *CMC 356* supports a mode for generating stationary signals of up to 3 kHz. This mode corrects the phase and gain errors of the output filter. The 3 dB bandwidth of this filter limits the amplitude at 3 kHz to about 70 % of the maximum range value. The application of the extended frequency range is the generation of harmonics and interharmonics.

Extended frequency range (1 ... 3 kHz)		
	Typical	Guaranteed
Low-level outputs ¹	Phase error <0.25° Amplitude error <0.25 %	Phase error <1° Amplitude error <1 %
Voltage amplifier	Phase error <0.25° Amplitude error <0.25 %	Phase error <1° Amplitude error <1 %

1. No extended frequency range support for external amplifiers.

1.5.3 Current outputs

2 × 3 current outputs ¹ (groups A and B)		
Output currents		
6-phase AC (L-N)	6 × 0 ... 32 A (Group A and B)	
3-phase AC (L-N)	3 × 0 ... 64 A (Group A and B parallel)	
2-phase AC (L-L) ^{2, 3}	2 × 0 ... 32 A (Group A and B)	
1-phase AC (L-L) ^{2, 3}	1 × 0 ... 64 A (Group A and B parallel)	
1-phase AC (L-L-L-L) ^{2, 3}	1 × 0 ... 32 A (Group A and B in series)	
2-phase AC (LL-LN) ²	2 × 0 ... 64 A (Group A and B)	
1-phase AC (LL-LN) ²	1 × 0 ... 128 A (Group A and B parallel)	
DC (LL-LN) ²	1 × 0 ... ±180 A (Group A and B parallel)	
	Typical	Guaranteed
Output power ⁴		
6-phase AC (L-N)	6 × 430 VA at 25 A	6 × 250 W at 20 A
3-phase AC (L-N)	3 × 860 VA at 50 A	3 × 500 W at 40 A
2-phase AC (L-L) ^{2, 3}	2 × 870 VA at 25 A	2 × 550 W at 20 A
1-phase AC (L-L) ^{2, 3}	1 × 1740 VA at 50 A	1 × 1100 W at 40 A
1-phase AC (L-L-L-L) ^{2, 3}	1 × 1740 VA at 25 A	1 × 1100 W at 20 A
2-phase AC (LL-LN) ²	2 × 500 VA at 40 A	2 × 350 W at 40 A
1-phase AC (LL-LN) ²	1 × 1000 VA at 80 A	1 × 700 W at 80 A
DC (LL-LN) ²	1 × 1400 W at ±80 A	1 × 1000 W at ±80 A
Accuracy ⁵		
$R_{load} \leq 0.5 \Omega$	Error <0.05 % of rd. + 0.02 % of rg.	Error <0.15 % of rd. + 0.05 % of rg.
Harmonic distortion (THD+N) ^{6, 7}	0.05 %	<0.15 %
Phase error ⁶	0.05°	<0.2°
DC offset current	<3 mA	<10 mA
Frequency range ^{8, 9}	Sinusoidal signals Harmonics/interharmonics Transient signals	0 (DC) ... 1000 Hz 10 ... 1000 Hz 0 (DC) ... 3100 Hz
Resolution	1 mA, 2 mA (2 phases in parallel), ...	

1. Data for 3-phase systems are valid for symmetric conditions (0°, 120°, 240°)
2. For wiring of single-phase modes → section 5 "Increasing the output power" on page 62.
3. Single-phase mode (in phase opposition).
4. Guaranteed data at 230 V power supply for ohmic loads (PF=1); typical data for inductive loads.
→ Section 1.2.1 "Operational limits in conjunction with a weak power supply input voltage" on page 4.
5. rd. = reading; rg. = range, whereas *n* % of rg. means: *n* % of upper range value
6. Valid for sinusoidal signals at 50/60 Hz and $R_{load} \leq 0.5 \Omega$.
7. Values at 20 kHz measurement bandwidth, nominal value, and nominal load.
8. For injections longer than 1 minute, the maximum fundamental frequency is limited to 587 Hz to comply with international trade restrictions for frequency-controlled signal generators. For other options, please contact OMICRON Support.
9. Amplitude derating at >380 Hz (→ "Current derating at high frequencies for sinusoidal signals" on page 10).

2 × 3 current outputs (groups A and B)	
Trigger on overload	Timer accuracy error <1 ms
Short-circuit protection	Unlimited
Open-circuit protection	Open outputs (open-circuit) permitted
Connection	4 mm socket, generator combination socket ¹ (CURRENT OUTPUT A only)
Insulation	Reinforced insulation of power supply and all SELV interfaces

1. For currents >32 A, connect the test object only to the 4 mm sockets and not to the generator combination socket.

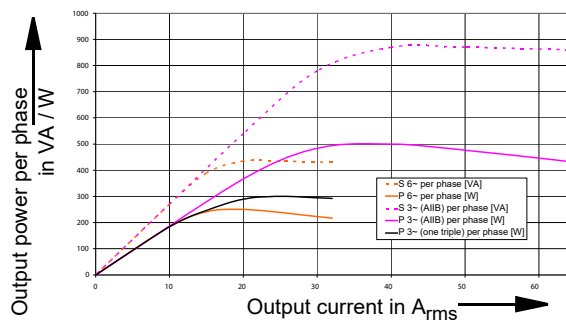

Guaranteed output power per phase of a group and when groups A and B are connected in parallel (active power values in W are guaranteed; apparent power values in VA are typical values)

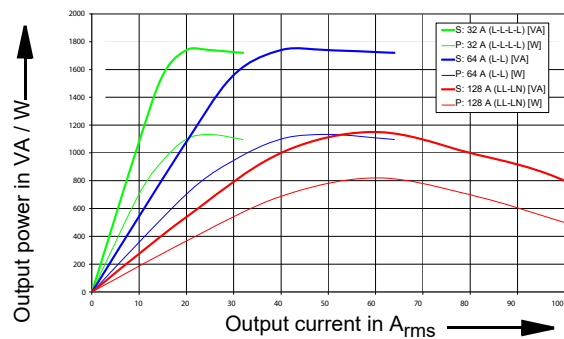

Guaranteed single phase output power curves (active power values in W are guaranteed; apparent power values in VA are typical values)

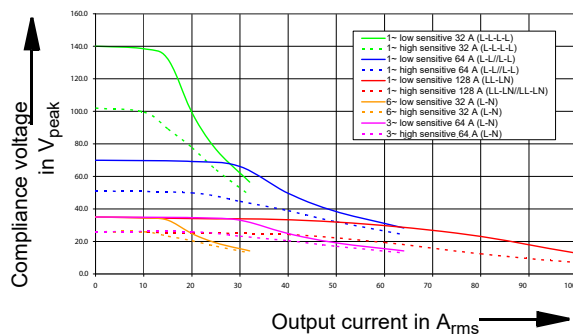

Typical compliance voltage (50/60 Hz)

The high and low sensitive curves correspond to the overload detection sensitivity settings in the *Test Universe* software. The low sensitive curves show the maximum available peak compliance voltage, which is mainly relevant for testing primary and electromechanical relays.

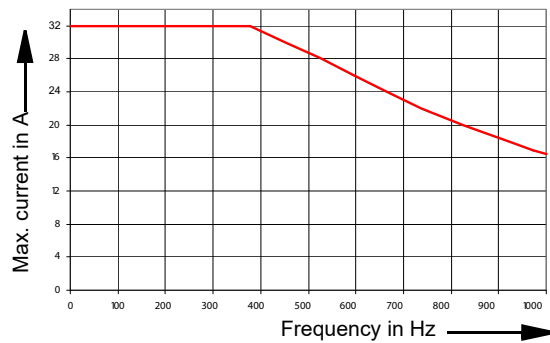

Current derating at high frequencies for sinusoidal signals

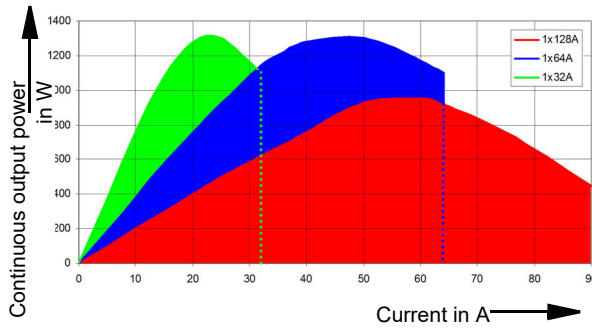

Typical continuous output current and output power at 23 °C; single-phase mode

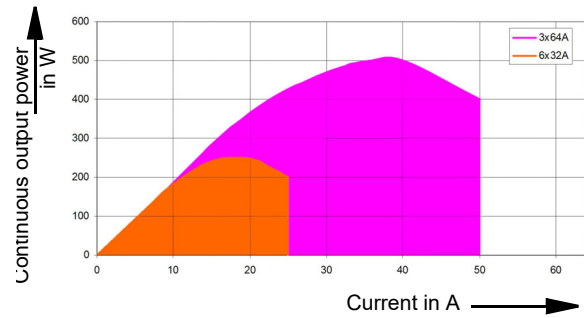

Typical continuous output current and output power at 23 °C; 3- and 6-phase mode

The continuous operating range is given by the area below the curves in the figures above.

If you don't require more than 64 A, we recommend to use the 1 × 64 A configuration rather than the 128 A configuration because the 1 × 64 A configuration provides more continuous output power.

Due to the large number of operating modes, it is not possible to give universally applicable curves for the discontinuous mode. However, the examples given below can be used instead to gain feeling for the possible output durations (t_1 is the possible duration of a cold device).

Typical duty cycles for operation at ambient temperature of 23 °C

	I [A]	P [W]	Duty cycle	t_1 [min]	t_{on} [s]	t_{off} [s]
6 × 32 A (L–N)	0 ... 25	0 ... 1200	100 %	>30	>1800	–
	26	1400	80 %	7.5	80	20
	29	1300	75 %	6.0	60	20
	32	1200	71 %	3.5	50	20
3 × 64 A (L–N)	0 ... 50	0 ... 1200	100 %	>30	>1800	–
	52	1400	80 %	7.5	80	20
	58	1300	75 %	6.0	60	20
	64	1200	71 %	3.5	50	20
1 × 128 A (LL–LN)	0 ... 80	0 ... 700	100 %	>30	>1800	–
	100	450	60 %	4.9	30	20
	120	300	43 %	2.6	15	20
	128	200	38 %	2.0	12	20

1.5.4 Voltage outputs

4 voltage outputs		
Output voltages		
4-phase AC (L-N) ¹	4 × 0 ... 300 V	
3-phase AC (L-N)	3 × 0 ... 300 V	
2-phase AC (L-L) ²	2 × 0 ... 600 V	
1-phase AC (L-N)	1 × 0 ... 300 V	
1-phase AC (L-L)	1 × 0 ... 600 V	
DC (L-N)	4 × 0 ... ±300 V	
	Typical	Guaranteed
Output power ³		
4-phase AC ⁴	4 × 75 VA at 100 ... 300 V	4 × 50 VA at 85 ... 300 V
3-phase AC ⁵	3 × 100 VA at 100 ... 300 V	3 × 85 VA at 85 ... 300 V
2-phase AC (L-L)	2 × 138 VA at 200 ... 600 V	2 × 125 VA at 200 ... 600 V
1-phase AC (L-N)	1 × 200 VA at 100 ... 300 V	1 × 150 VA at 75 ... 300 V
1-phase AC (L-L)	1 × 275 VA at 200 ... 600 V	1 × 250 VA at 200 ... 600 V
DC (L-N)	1 × 420 W at 300 V _{DC}	1 × 360 W at 300 V _{DC}
Accuracy ⁶	Error <0.03 % of rd. + 0.01 % of rg.	Error <0.08 % of rd. + 0.02 % of rg.
Harmonic distortion (THD+N) ^{7, 8}	0.015 %	<0.05 %
Phase error ⁷	0.02°	<0.1°
DC offset voltage	<20 mV	<100 mV
Voltage ranges	Range I: Range II:	0 ... 150 V 0 ... 300 V
Frequency ranges ^{9, 10}	Sinusoidal signals Harmonics/interharmonics ¹¹ Transient signals	10 ... 1000 Hz 10 ... 3000 Hz 0 (DC) ... 3100 Hz
Resolution	Range I: Range II:	5 mV 10 mV
Short-circuit protection	Unlimited for L–N	
Connection	4 mm sockets; generator combination socket V _{L1} –V _{L3}	
Insulation	Reinforced insulation of power supply and all SELV interfaces	

1. a) $V_{L4}(t)$ automatically calculated: $V_{L4} = (V_{L1} + V_{L2} + V_{L3}) * C$. C: configurable constant from –100 to +100.

b) V_{L4} can be configured by software in frequency, phase, and amplitude.

2. Without common neutral (N).

3. Guaranteed data for ohmic loads (PF = 1). Refer to the accompanying figures of the output power curves.

4. Data for 4-phase systems are valid for symmetric conditions (0°, 90°, 180°, 270°)

5. Data for 3-phase systems are valid for symmetric conditions (0°, 120°, 240°)

6. rd. = reading; rg. = range, whereas n % of rg. means: n % of upper range value

7. Valid for sinusoidal signals at 50/60 Hz.

8. Values at 20 kHz measurement bandwidth, nominal value, and nominal load

9. For injections longer than 1 minute, the maximum fundamental frequency is limited to 587 Hz to comply with international trade restrictions for frequency-controlled signal generators. For other options, please contact OMICRON Support.

10. Amplitude derating at >1000 Hz.

11. Signals above 1000 Hz are only supported in selected software modules.

Power diagram for 3-phase operation

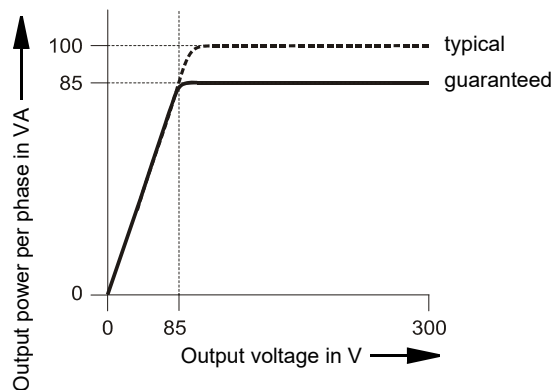

Power diagram for single-phase operation

Section 5.2 "Voltage outputs" on page 64

Single-phase operation L-N

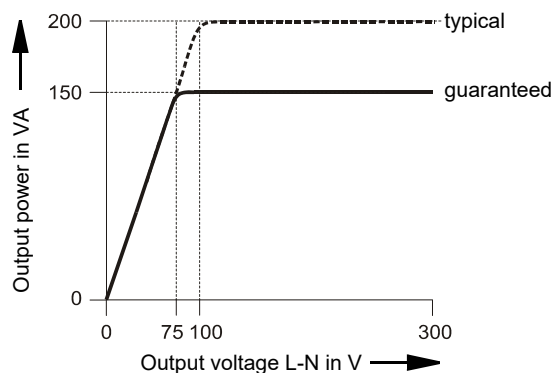

Single-phase operation L-L

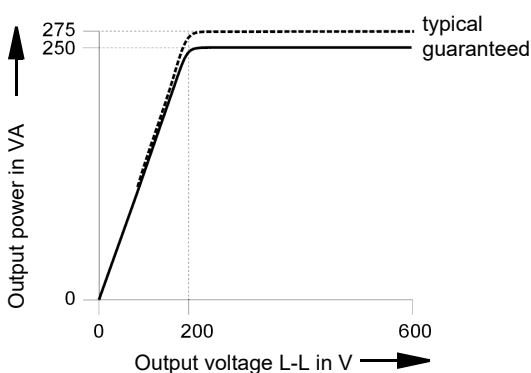

1.5.5 Low-level outputs LL out for external amplifiers

Note: The low-level outputs **LL out 7–12** are only available if the option *LLO-2* is installed.

Both SELV interface connectors **LL out 1–6** as well as the optional **LL out 7–12** (if applicable) hold 2 independent generator triples each. These 6 high-accuracy analog signal sources per connector can be used to either control an external amplifier or to directly provide low-level outputs.

In addition, each SELV interface connector provides a serial digital interface (pins 8–16; see below) that transmits control and monitor functions between the *CMC 356* and the external amplifiers.

Supported devices are the *CMS 356* or the discontinued devices *CMA 156*, *CMA 56*, *CMS 156*, *CMS 251* and *CMS 252*.

The low-level outputs are short-circuit-proof and continually monitored for overload. They are separated through reinforced insulation from the power input and from the voltage and current outputs. They deliver calibrated signals in the range from 0 to 7 V_{eff} nominal (0 to $\pm 10 V_{peak}$).

Both the selection of the particular amplifier as well as the specification of the range of the amplifier takes place in the software.

Pin assignment of **LL out 1–6** (lower 16-pole LEMO socket); view onto the connector from the cable wiring side:

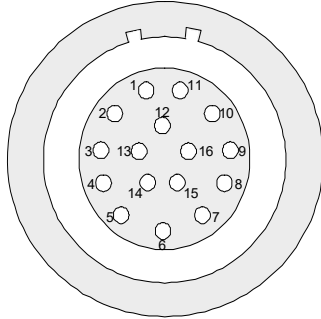

Pin	Function LL out 1–6	Function LL out 7–12
1	LL out 1	LL out 7
2	LL out 2	LL out 8
3	LL out 3	LL out 9
4	Neutral (N) connected to GND	
5	LL out 4	LL out 10
6	LL out 5	LL out 11
7	LL out 6	LL out 12
8–16	For internal purposes	
Housing	Screen connection	

LL out 1–3 and LL out 4–6 (and optionally LL out 7–9 and LL out 10–12) each make up a selectable voltage or current triple.

6 outputs "LL out 1–6" and 6 (optional) outputs "LL out 7–12"		
Output voltage range	0 ... ±10 V _{peak} ¹ (SELV)	
Output current	Max. 1 mA	
	Typical	Guaranteed
Accuracy	Error <0.025 %	Error <0.07 % for 1 ... 10 V _{peak}
Harmonic distortion (THD+N) ²	<0.015 %	<0.05 %
Phase error ³	0.02°	<0.1°
DC offset voltage	<150 µV	<1.5 mV
Frequency range ⁴	Sinusoidal signals Harmonics/interharmonics ⁵ Transient signals	0 (DC) ... 1000 Hz 10 ... 3000 Hz 0 (DC) ... 3100 Hz
Resolution	<250 µV	
Unconventional CT/VT simulation	Linear or Rogowski ⁶ mode (transient and sinewave)	
Short-circuit protection	Unlimited to GND	
Overload indication	Yes	
Insulation	Reinforced insulation to all other potential groups of the test equipment. GND is connected to protective earth (PE).	

1. Input OMICRON amplifier nominal: 0 ... 5 V_{RMS}
2. Values at nominal voltage (10 V_{peak}), 50/60 Hz, and 20 kHz measurement bandwidth.
3. Valid for sinusoidal signals at 50/60 Hz.
4. Amplitude derating at >1000 Hz.
5. Signals above 1000 Hz are only supported in selected software modules.
6. When simulating Rogowski sensors, the output voltage is proportional to the derivative of the current with respect to time (di(t)/dt).

Manufacturer ordering information	
Connector for two-guide notches and pull relief (for LL out)	FGB.2B.316.CLAD 72Z
Black anti-bend cable cover	GMA.2B.070 DN

For a manufacturer description about the connection sockets **LL out** and the external interface **ext. Interf.**, visit the website www.lemo.com. You can order the LEMO cable directly from OMICRON.

1.5.6 Low-level binary outputs (ext. Interf.)

The SELV interface connector **ext. Interf.** holds 4 additional transistor binary outputs (**BINARY OUTPUT 11–14**). Unlike regular relay outputs, **BINARY OUTPUT 11–14** are bounce-free binary outputs and have a minimal reaction time.

In addition, 2 high-frequency counter inputs for up to 100 kHz are available for the testing of energy meters. They are described in section 1.6.2 "Counter inputs 100 kHz (low level)" on page 21.

Pin assignment of the external interface **ext. Interf.** (upper 16-pole LEMO socket); view onto the connector from the cable wiring side:

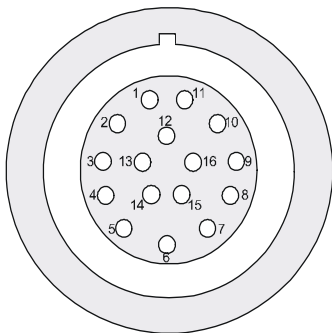

Pin	Function
Pin 1	Counter input 1
Pin 2	Counter input 2
Pin 3	Reserved
Pin 4	Neutral (N) connected to GND
Pin 5	Binary output 11
Pin 6	Binary output 12
Pin 7	Binary output 13
Pin 8	Binary output 14
Pin 9–16	Reserved
Housing	Screen connection

4 low-level transistor binary outputs (BINARY OUTPUT 11–14)	
Type	Open-collector transistor outputs; external pull-up resistor
Rated voltage	Max. ±16 V
Rated current	Max. 5 mA (current limited); min. 100 µA
Update rate	10 kHz
Rise time	<3 µs ($V_{\text{extern}} = 5 \text{ V}$, $R_{\text{pullup}} = 4.7 \text{ k}\Omega$)
Connection	Connector ext. Interf. (CMC 356 rear side)
Insulation	Reinforced insulation to all other potential groups of the test equipment. GND is connected to protective earth (PE).

Circuit diagram of **ext. Interf.** binary transistor outputs 11–14:

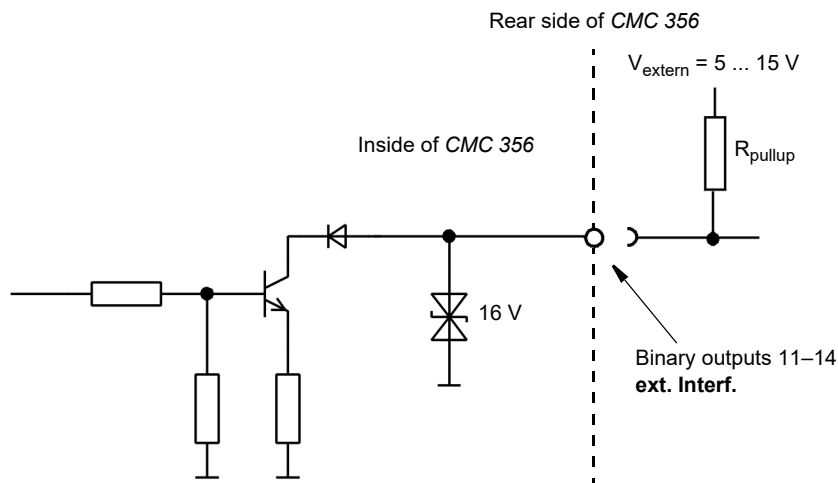

Manufacturer ordering information	
Connector for one-guide notch and pull relief (for ext. Interf.)	FGG.2B.316.CLAD 72Z
Black anti-bend cable cover	GMA.2B.070 DN

For a manufacturer description about the connection sockets **LL out** and the external interface **ext. Interf.**, visit the website www.lemo.com. You can order the LEMO cable directly from OMICRON.

1.5.7 Binary output relays

4 binary output relays (BINARY OUTPUT 1–4)	
Type	Potential-free contacts; software-controlled
Connection	4 mm sockets
AC loading capacity	$V_{\max} = 300 \text{ V}$, $I_{\max} = 8 \text{ A}$, $P_{\max} = 2000 \text{ VA}$
AC breaking capacity	
DC loading capacity	→ "Load limit breaking capacity curve for binary output relays with DC voltages" on page 17.
DC breaking capacity	
Inrush current	15 A (max. 4 s at 10 % duty cycle)
Carry capacity	5 A continuous at 60 °C (140 °F)
Electrical lifetime	100 000 switching cycles at 230 V_{AC} /8 A and ohmic load
Operate time	Max. 10 ms (no bouncing)
Release time	Max. 5 ms (no bouncing)
Overvoltage category	II, according to IEC 61010-1

The accompanying diagram shows the load limit curve for DC voltages. For AC voltages, a maximum power of 2000 VA is achieved.

Load limit breaking capacity curve for binary output relays with DC voltages

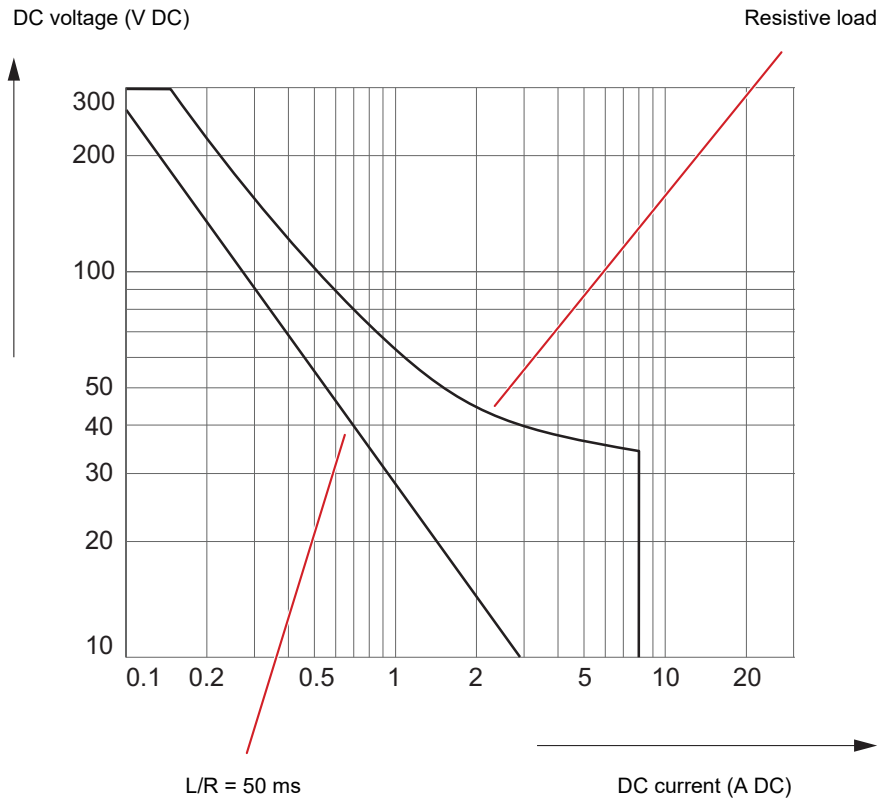

1.5.8 DC supply (AUX DC)

DC supply (AUX DC)		
Voltage ranges	0 ... 66 V _{DC} (max. 0.8 A) 0 ... 132 V _{DC} (max. 0.4 A) 0 ... 264 V _{DC} (max. 0.2 A)	
Power	Max. 50 W	
Accuracy ¹	Typical	Guaranteed
	Error <2 %	Error <5 %
Resolution	<70 mV	
Connection	4 mm sockets on front panel	
Short-circuit protection	Yes	
Overload indication	Yes	
Insulation	Reinforced insulation from power supply and all SELV interfaces	

1. Percentage is with respect to each range's full-scale.

1.6 Inputs

1.6.1 Binary/analog inputs

General data of binary inputs 1...10	
Number of binary inputs	10
Trigger criteria	Potential-free or DC-voltage compared to threshold voltage
Reaction time	Max. 220 μ s
Sampling rate	10 kHz
Time resolution	100 μ s
Maximum measuring time	Unlimited
Debounce/deglitch time	0 ... 25 ms (\rightarrow page 20)
Counting function	
Counter frequency	<3 kHz (per input)
Pulse width	>150 μ s (for high and low signals)
Connection	4 mm sockets
Insulation	5 galvanically insulated binary groups with each 2 inputs having its own GND. Functional insulation to the power outputs, DC inputs and between galvanically separated groups. Reinforced insulation from all SELV interfaces and from power supply.

Data for potential-sensing operation

	Default configuration		ELT-1 measurement option	
Range/resolution	20 ... 300 V 0 ... 20 V	500 mV 50 mV	±600 V ±100 V ±10 V ±1 V ±100 mV	20 V 2 V 200 mV 20 mV 2 mV
Maximum input voltage	CAT IV: 150 V CAT III: 300 V		CAT IV: 150 V CAT III: 300 V CAT II: 600 V	
Threshold voltage accuracy ¹	5 % of rd. + 0.5 % of rg.		Range ±600 V: Typ.: error <5 %, guar.: error <10 % Other ranges: Typ.: error <2 %, guar.: error <4 %	
Typical threshold voltage hysteresis	Range 20 ... 300 V: 900 mV Range 0 ... 20 V: 60 mV		Range ±600 V: 1.3 % of rd. + 5.8 % of rg. Other ranges: 1.3 % of rd. + 3.5 % of rg.	
Input impedance	Threshold 20 ... 300 V: 135 kΩ Threshold 0 ... 20 V: 210 kΩ		500 kΩ (50 pF)	

1. Valid for positive voltage signal edge; percentage is shown in respect to each range's full-scale.

For further information about possibilities and the specification of the **ELT-1** measurement option → section 1.13 "ELT-1 measurement option" on page 30.

Data for potential-free operation

	Default configuration	ELT-1 measurement option
Trigger criteria		
Logical 0	R >100 kΩ	R >80 kΩ
Logical 1	R <10 kΩ	R <40 kΩ
Input impedance	216 kΩ	162 kΩ (50 pF)

For further information about possibilities and the specification of the **ELT-1** measurement option → section 1.13 "ELT-1 measurement option" on page 30.

Deglitching input signals

In order to suppress short spurious pulses, a deglitching algorithm could be configured. The deglitch process results in an additional dead time and introduces a signal delay. In order to be detected as a valid signal level, the level of an input signal must have a constant value at least during the deglitch time.

The figure below illustrates the deglitch function.

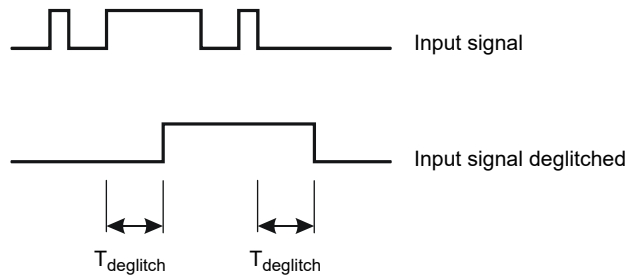

Debouncing input signals

For input signals with a bouncing characteristic, a debounce function can be configured. This means that the first change of the input signal causes the debounced input signal to be changed and then be kept on this signal value for the duration of the debounce time.

The debounce function is placed after the deglitch function described above and both are realized by the firmware of the CMC 356 and are calculated in real time.

The figure below illustrates the debounce function. On the right-hand side of the figure, the debounce time is too short. As a result, the debounced signal rises to "high" once again, even while the input signal is still bouncing and does not drop to a low level until another $T_{debounce}$ period has expired.

The figure below illustrates the debounce function.

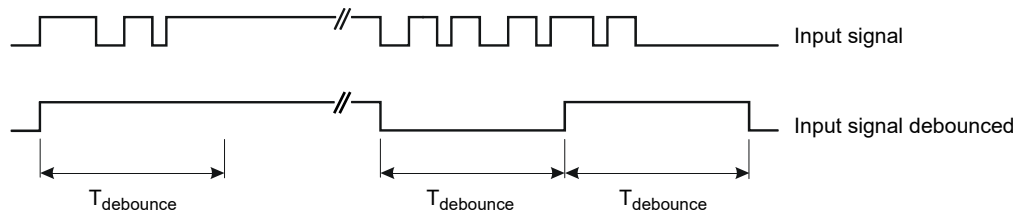

1.6.2 Counter inputs 100 kHz (low level)

The SELV interface connector **ext. Interf.** holds 2 high-frequency counter inputs for up to 100 kHz which are used for testing energy meters.

In addition, 4 additional transistor binary outputs (**BINARY OUTPUT 11–14**) are available. They are described in section 1.5.6 "Low-level binary outputs (ext. Interf.)" on page 15.

Pin assignment of the external interface **ext. Interf.** (upper 16-pole LEMO socket); view onto the connector from the cable wiring side:

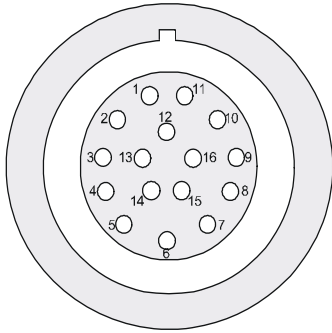

Pin	Function
Pin 1	Counter input 1
Pin 2	Counter input 2
Pin 3	Reserved
Pin 4	Neutral (N) connected to GND
Pin 5	Binary output 11
Pin 6	Binary output 12
Pin 7	Binary output 13
Pin 8	Binary output 14
Pin 9–16	Reserved
Housing	Screen connection

2 counter inputs	
Maximum counter frequency	100 kHz
Pulse width	>3 μ s (high and low signal)
Switch threshold	
Pos. edge	Max. 8 V
Neg. edge	Min. 4 V
Hysteresis	Typ. 2 V
Rise and fall times	<1 ms
Maximum input voltage	\pm 30 V
Connection	Socket ext. Interf. (rear side of CMC 356)
Insulation	Reinforced insulation to all other potential groups of the test equipment. GND is connected to protective earth (PE).

Circuit diagram of **ext. Interf.** counter inputs 1 and 2:

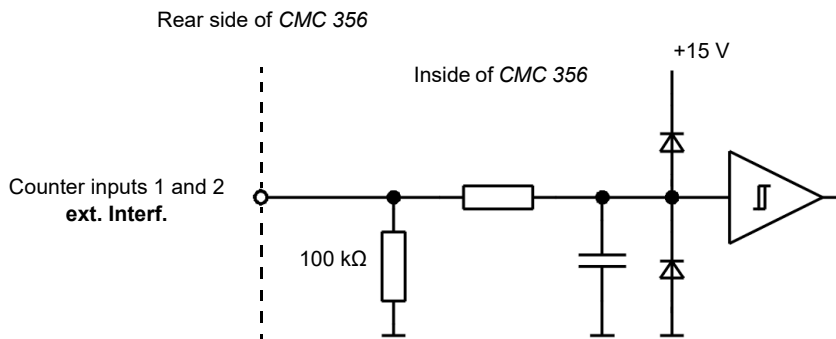

Manufacturer ordering information	
Connector for one-guide notch and pull relief (for ext. Interf.)	FGG.2B.316.CLAD 72Z
Black anti-bend cable cover	GMA.2B.070 DN

For a manufacturer description about the connection sockets **LL out 1–6** and external interface **ext. Interf.**, visit the website www.lemo.com. You can order the LEMO cable directly from OMICRON.

1.6.3 DC measurement inputs (ANALOG DC INPUT)

DC measurement inputs are only available with the **ELT-1** measurement option.

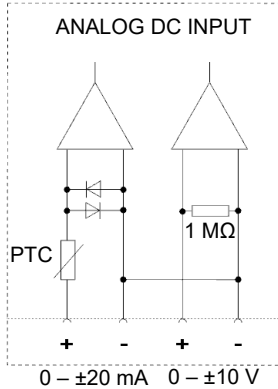

Note: Exceeding the specified input values can damage the measurement inputs.

DC measurement input I_{DC}		
Measurement range	0 ... ±1 mA and 0 ... ±20 mA	
Maximum input current	600 mA	
Accuracy	Typical	Guaranteed
	Error <0.003 % of rg. ¹	Error <0.02 % of rg.
Input impedance	Approx. 15 Ω	
Connection	4 mm sockets	
Insulation	Functional insulation to all other front panel connections; reinforced insulation from all SELV interfaces and from power supply; galvanically connected to V_{DC}	

DC voltage measurement input V_{DC}		
Measurement range	0 ... ±10 V	
Maximum input voltage	±11 V	
Input impedance	1 MΩ	
Maximum input current	±90 mA	
Accuracy	Typical	Guaranteed
	Error <0.003 % of rg. ¹	Error <0.02 % of rg.
Insulation	Galvanically connected to I_{DC}	

1. rg. = range, whereas *n* % of rg. means: *n* % of upper range value

1.7 IEC 61850 protocols

IEC 61850 GOOSE	
Simulation	Mapping of binary outputs to data attributes in published GOOSE messages. Number of virtual binary outputs: 360 Number of GOOSE to be published: 128
Subscription	Mapping of data attributes from subscribed GOOSE messages to binary inputs. Number of virtual binary outputs: 360 Number of GOOSE to be published: 128
Performance	Type 1A; Class P2/3 (IEC 61850-5). Processing time (application to network or vice versa): <1 ms
VLAN support	Selectable priority and VLAN-ID





IEC 61850 Sampled Values (Publishing)	
Specification	According to the "Implementation Guideline for Digital Interface to Instrument Transformers Using IEC 61850-9-2" of the UCA International Users Group and the "IEC 61869-9 Instrument transformers – Part 9: Digital interface for instrument transformers"
Sample rate	<ul style="list-style-type: none"> • 4000 Hz (80 SPC @ 50 Hz) – 1 sample per packet • 4800 Hz (80 SPC @ 60 Hz) – 1 sample per packet • 4800 Hz – 2 samples per packet • 5760 Hz – 1 sample per packet • 12800 Hz (256 SPC @ 50 Hz) – 8 samples per packet • 14400 Hz – 6 samples per packet • 15360 Hz (256 SPC @ 60 Hz) – 8 samples per packet
Synchronization	Synchronization attribute (smpSynch) can follow the synchronization status of the test set or be set to distinct values. Sample count (smpCnt) zero is aligned with top of the second (IRIG-B and PPS). For the accuracy data → section "Absolute time synchronization" on page 6.
VLAN support	Selectable priority and VLAN-ID
Maximum number of SV streams	<i>Test Universe</i> : 3 <i>RelaySimTest</i> : 4

1.8 Technical data of the communication ports

1.8.1 NET-2 board

The NET-2 board requires a *Test Universe* software version **3.00 SR2** (or later), or a *CMControl* software version 2.30 (or later).





NET-2: 2 × USB port and Ethernet ports ETH1/ETH2			
 USB	USB type	USB 2.0 high speed up to 480 Mbit/s	
	USB connector	USB type A (for future use of USB peripherals)	
	Output current	Max. 500 mA	
 USB	USB type	USB 2.0 high speed up to 480 Mbit/s; USB 1.1-compatible	
	USB connector	USB type B (connect to computer)	
	USB cable	USB 2.0 high speed type A-B, 2 m/6 ft	
 ETH	ETH type	10/100/1000Base-TX ¹ (twisted pair, auto-MDI/MDIX or auto-crossover)	
	ETH connector	RJ45	
	ETH cable type	Shielded LAN cable of category 5 (CAT5) or better	
	ETH port status LED	Depending on the ETH type of your NET-2 interface board's counterpart, the status LED's behavior varies. Physical link established, port active:	
		Mbit/s	Active LED ON
		10	yellow
		100	green
	1000	yellow + green	
	If there is traffic via an ETH port, the active LEDs start blinking.		
ETH Power over Ethernet (PoE)	IEEE 802.3af compliant Port capability limited to one Class 1 (3.84 W) and one Class 2 (6.49 W) power device		

1. 10Base = 10 Mbit/s transfer rate
100Base = 100 Mbit/s transfer rate
1000Base = 1000 Mbit/s transfer rate

1.8.2 NET-1C board (legacy board)





NET-1C: USB port and Ethernet ports ETH1/ETH2		
 USB	USB type ¹	USB 2.0 full speed up to 12 Mbit/s
	USB connector	USB type B (connect to computer)
	USB cable	USB 2.0 high speed type A-B, 2 m/6 ft
 ETH	ETH type	10/100Base-TX (10/100Mbit, twisted pair, auto-MDI/MDIX or auto-crossover)
	ETH connector	RJ45
	ETH cable type	Shielded LAN cable of category 5 (CAT5) or better
	ETH port status LED 	<ul style="list-style-type: none"> Physical link established, port active: green LED ON Traffic via ETH port: yellow LED is blinking
	ETH Power over Ethernet (PoE)	IEEE 802.3af compliant Port capability limited to one Class 1 (3.84 W) and one Class 2 (6.49 W) power device

- For the **USB** port to work, the NET-1C board requires a *Test Universe* software version 3.00 (or later) plus the matching *CMC* firmware

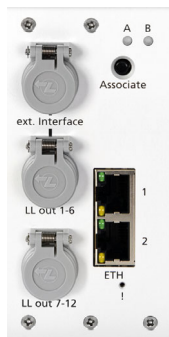



1.8.3 NET-1B board (legacy board)



NET-1B: Ethernet ports ETH1 and ETH2		
 ETH	Type	10/100Base-TX (10/100Mbit, twisted pair, auto-MDI/MDIX or auto-crossover)
	Connector	RJ45
	Cable type	Shielded LAN cable of category 5 (CAT5) or better
	ETH port status LED 	<ul style="list-style-type: none"> Physical link established, port active: green LED ON Traffic via ETH port: yellow LED is blinking
ETH Power over Ethernet (PoE)	IEEE 802.3af compliant Port capability limited to one Class 1 (3.84 W) and one Class 2 (6.49 W) power device	

1.8.4 NET-1 board (legacy board)

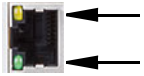

NET-1: Ethernet ports ETH1 and ETH2		
 ETH2	Type	100Base-FX (100 Mbit, fiber, duplex)
	Connector	MT-RJ
	Cable type	50/125 µm or 62.5/125 µm (duplex patch cable)
	Cable length	>1 km/0.62 miles possible
	ETH2 port status LED 	<ul style="list-style-type: none"> Physical link established, port active: green LED ON Traffic via ETH port: yellow LED is blinking
	This is a product of Laser Class 1 (IEC 60825-1:2014)	
 ETH1	Type	10/100Base-TX (10/100Mbit, twisted pair, auto-MDI/MDIX or auto-crossover)
	Connector	RJ45
	Cable type	Shielded LAN cable of category 5 (CAT5) or better
	ETH1 port status LED 	<ul style="list-style-type: none"> Physical link established, port active: green LED ON Traffic via ETH port: yellow LED is blinking

1.9 Environmental conditions

Climate	
Operating temperature	0 ... +50 °C (+32 ... +122 °F), a 50 % duty cycle may apply above +30 °C (+86 °F)
Storage	-25 ... +70 °C (-13 ... +158 °F)
Maximum altitude	2000 m (6560 ft)
Humidity	5 ... 95 % relative humidity; no condensation
Climate	Tested according to IEC 60068-2-78

Shock and vibration	
Vibration	Tested according to IEC 60068-2-6; frequency range 10 ... 150 Hz; 2 g (20 sweeps)
Shock	Tested according to IEC 60068-2-27; 15 g/11 ms, half-sinusoid, each axis

1.10 Mechanical data

Size, weight and protection	
Weight	16.8 kg (37 lb)
Dimensions W × H × D (without handle)	450 × 145 × 390 mm (17.7 × 5.7 × 15.4")
Housing	IP20 according to IEC 60529

1.11 Safety standards, electromagnetic compatibility (EMC) and certificates

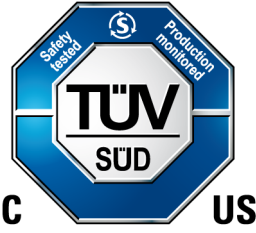
Electromagnetic interference (EMI)	
Europe	EN 61326-1; EN 61000-6-4; EN 61000-3-2/3; EN 55032 (Class A)
International	IEC 61326-1; IEC 61000-6-4; IEC 61000-3-2/3; CISPR 32 (Class A)
USA	47 CFR 15 Subpart B (Class A) of FCC
Electromagnetic susceptibility (EMS)	
Europe	EN 61326-1; EN 61000-6-2; EN 61000-4-2/3/4/5/6/8/11/16/18; EN 61000-6-5
International	IEC 61326-1; IEC 61000-6-2; IEC 61000-4-2/3/4/5/6/8/11/16/18; IEC 61000-6-5
Safety standards	
Europe	EN 61010-1; EN 61010-2-030
International	IEC 61010-1; IEC 61010-2-030
USA	UL 61010-1; UL 61010-2-030
Canada	CAN/CSA-C22.2 No 61010-1; CAN/CSA-C22.2 No 61010-2-030
Certificate	 <p>Manufactured under an ISO 9001 registered system</p>

1.12 Electrical insulation groups

The following chapter shows how the inputs and outputs of CMC test sets are insulated against PE and each other.

B = Basic insulation

R = Reinforced insulation

F = Functional insulation

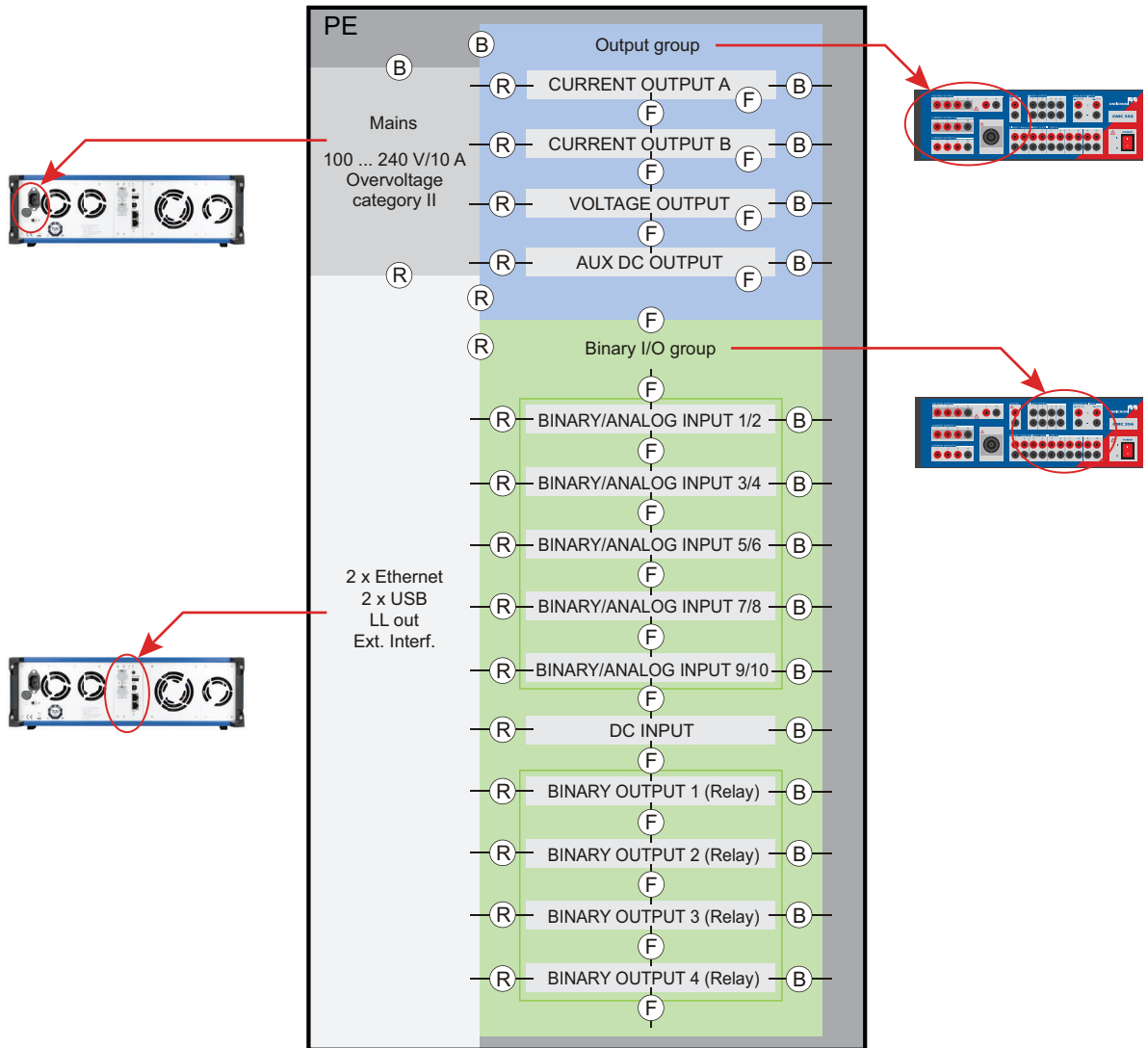

Insulation designed for pollution degree 2.

1.13 ELT-1 measurement option

The **ELT-1** measurement option enables the *CMC 356* to measure analog signals:

- Analog DC inputs (+/-10V and either +/-1mA or +/-20mA) for basic transducer testing with the test module *QuickCMC*.
- Basic voltage and current measurements with up to 3 of the 10 analog measurement inputs (restricted *EnerLyzer* mode).

The fully-featured measurement functionality on all 10 channels requires the *Test Universe* module *EnerLyzer*.

Using the *CMC 356* test set in combination with the *Test Universe* module *Transducer* enables advanced testing of multifunctional single-phase and 3-phase electrical transducers with symmetrical or non-symmetrical operating characteristics.

The **ELT-1** measurement option can either be ordered with the new test set or later as a factory upgrade (the *CMC 356* needs to be returned to OMICRON).

As the analog inputs of the *CMC 356* are voltage inputs, active current clamps or current shunts (*C-Shunt 1* or *C-Shunt 10*) with voltage outputs have to be used to measure currents.

OMICRON offers the *C-PROBE1* as a suitable current clamp. This current clamp is not included in the delivery of the *EnerLyzer* measurement option. Please order it separately (→ "Support" on page 69).

1.13.1 General data

The analog measurement inputs have 5 measurement ranges that can be individually configured in the *EnerLyzer* test module.

- 100 mV
- 1 V
- 10 V
- 100 V
- 600 V

These range limits refer to the respective RMS values of the sinusoidal-shaped input signals. The ranges 100 mV, 1 V, 10 V and 100 V could be overloaded approximately with 10 %.

Input impedance: 500 kΩ || 50 pF for all measurement ranges

The sampling rate can be configured by software:

- 28.44 kHz
- 9.48 kHz
- 3.16 kHz

Four different operating modes are possible:

- Multimeter mode (→ section 1.13.2 on page 31)
- Harmonic analysis (→ section 1.13.3 on page 40)
- Transient recording (→ section 1.13.4 on page 43)
- Trend recording

1.13.2 Multimeter mode

This operating mode is designed for measuring steady-state signals (for example, also non-sinusoidal shaped). It can be used for measurements such as RMS values, phase angle, frequency, etc.

The input signals are processed in real time without delay.

Accuracy AC measurements

Conditions: integration time 1 s, measurement signal sinusoidal, excitation 10 ... 100 %, accuracy references the measurement full-scale values.

Sampling rate 28.44 kHz, measurement range 600 V, 100 V, 10 V, 1 V:

Frequency range	Accuracy	
	Typical	Guaranteed
DC	±0.15 %	±0.40 %
10 Hz ... 100 Hz	±0.06 %	±0.15 %
10 Hz ... 1 kHz	+0.06 %/-0.11 %	±0.25 %
10 Hz ... 10 kHz	+0.06 %/-0.7 %	±1.1 %

Sampling rate 28.44 kHz, measurement range 100 mV:

Frequency range	Accuracy	
	Typical	Guaranteed
DC	±0.15 %	±0.45 %
10 Hz ... 100 Hz	±0.1 %	±0.3 %
10 Hz ... 1 kHz	+0.15 %/-0.2 %	±0.5 %
10 Hz ... 10 kHz	+0.15 %/-1.0 %	±2 %

Sampling rate 9.48 kHz, 3.16 kHz; measurement range 600 V, 100 V, 10 V, 1 V:

Frequency range	Accuracy	
	Typical	Guaranteed
DC	±0.15 %	±0.45 %
10 Hz ... 100 Hz	±0.08 %	±0.2 %
10 Hz ... 1 kHz	+0.1 %/-0.3 %	±0.5 %
10 Hz ... 4 kHz (sampling rate 9.48 kHz)	+0.1 %/-0.5 %	±1.2 %
10 Hz ... 1.4 kHz (sampling rate 3.16 kHz)	+0.1 %/-0.5 %	±1.0 %

Sampling rate 9.48 kHz, 3.16 kHz; measurement range 100 mV:

Frequency range	Accuracy	
	Typical	Guaranteed
DC	±0.15 %	±0.5 %
10 Hz ... 100 Hz	±0.1 %	±0.35 %
10 Hz ... 1 kHz	+0.15 %/−0.35 %	±0.5 %
10 Hz ... 4 kHz (sampling rate 9.48 kHz)	+0.15 %/−0.6 %	±1.2 %
10 Hz ... 1.4 kHz (sampling rate 3.16 kHz)	+0.15 %/−0.6 %	±1.2 %

The accuracy data contains linearity, temperature, long-term drift, and frequency.

Typical frequency response with a sampling rate of 28.44 kHz and an input voltage of 70 V:

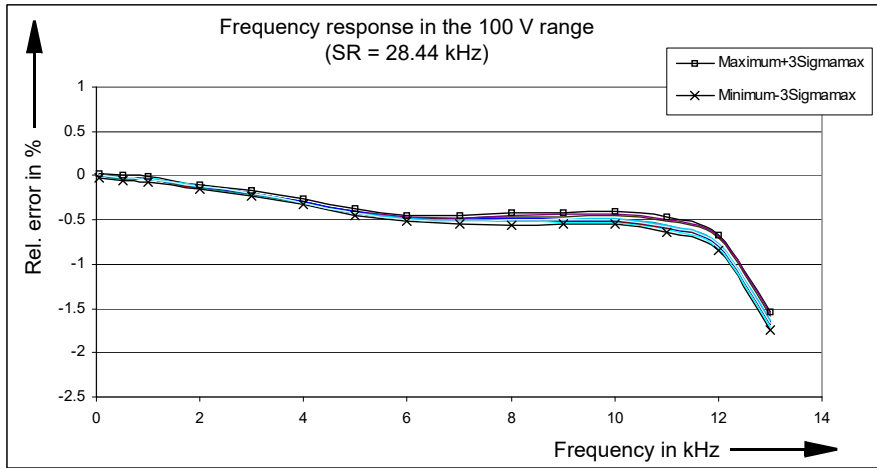

Typical frequency response with a sampling rate of 9.48 kHz and an input voltage of 70 V:

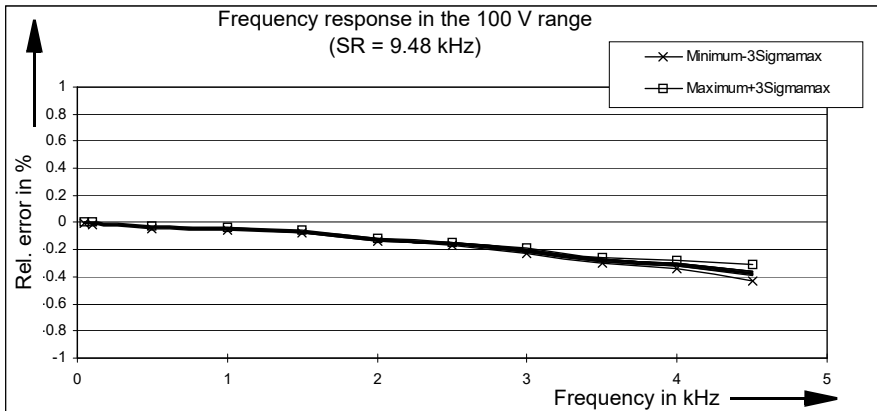

Typical AC linear progression at 50 Hz and a sampling rate of 28.44 kHz:

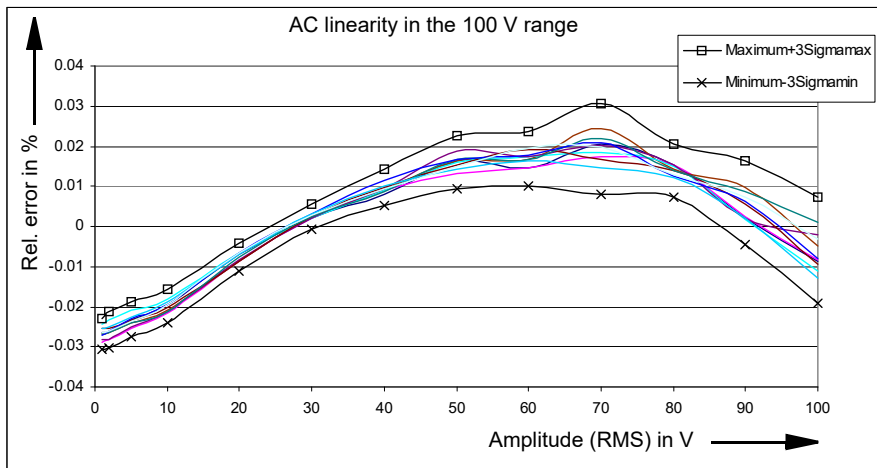

Note:

a) Relative error: $\frac{\text{Actual} - \text{Expected}}{\text{Full scale}} \times 100 \%$

b) 3Sigma_{max} represents the maximum of the 3Sigma values of all 10 input channels.
 The 3Sigma_{max} values of an analog input are determined from 50 measurement values.

Channel cross-talk

Conditions: sinusoidal form infeed on a channel without overload, AC measurement on neighboring channel, integration time 1 s.

Cross-talk dampening on channels of the same potential groups in dB at f = 50 Hz:

Measurement range	600 V	100 V	10 V	1 V	100 mV
Dampening in dB	80	105	95	120	120

Cross-talk dampening on channels of the same potential groups in dB at f = 500 Hz:

Measurement range	600 V	100 V	10 V	1 V	100 mV
Dampening in dB	65	80	75	95	95

The cross-talk dampening on a neighboring channel of another potential group is greater than 120 dB in all measurement ranges (f = 50 Hz or 500 Hz).

Accuracy phase measurements

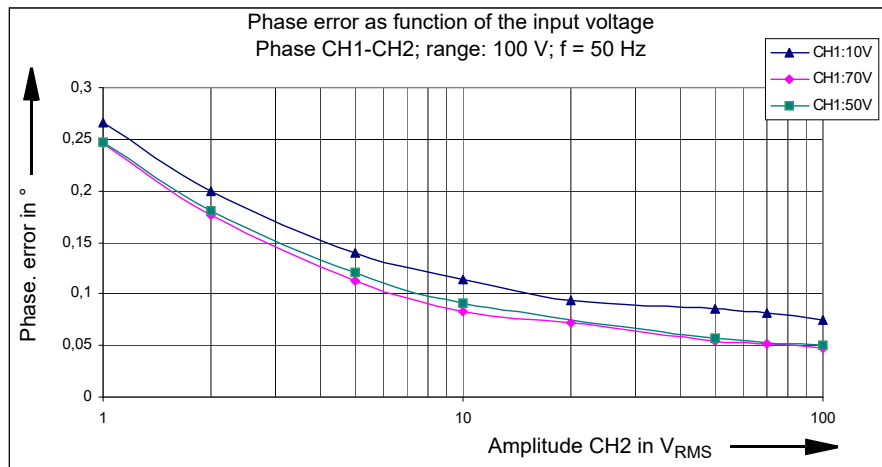

Conditions: integration time 1 s, measurement signal sinusoidal, measurement range 100 V, f = 50 Hz, sampling rate 28.44 kHz

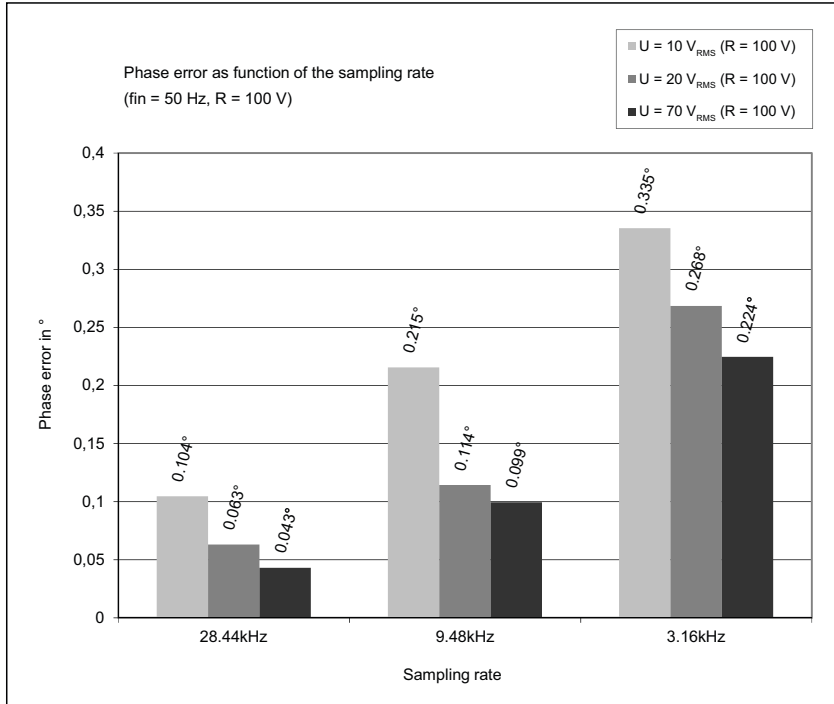

Conditions: integration time 1 s, measurement signal sinusoidal, $f = 50 \text{ Hz}$, measurement range 100 V, both channels same excitation (20 V, 70 V)

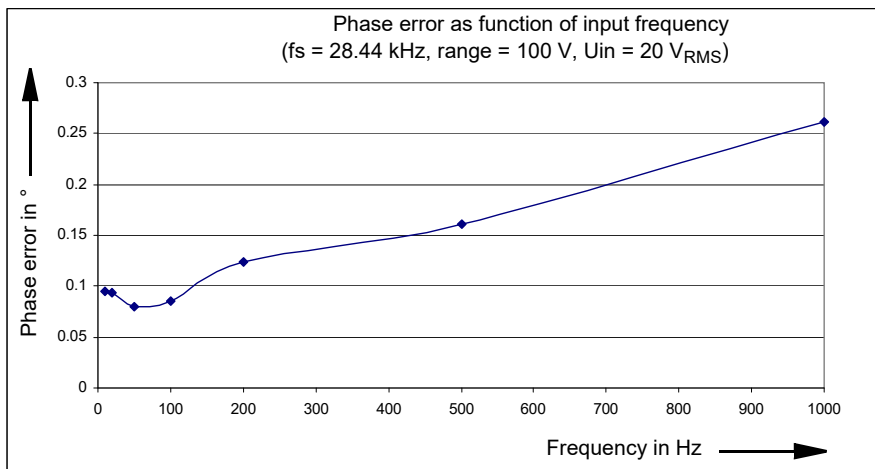

Conditions: integration time 1 s, measurement signal sinusoidal, sampling rate = 28.44 kHz, measurement range 100 V, excitation on both channels 20 V_{RMS}

The maximum input frequency for the phase measurement depends on the sampling rate.

Sampling rate	Input frequency range
28.44 kHz	10 Hz ... 2.30 kHz
9.48 kHz	10 Hz ... 750 Hz
3.16 kHz	10 Hz ... 250 Hz

Note:

1. The measurement accuracy of phase can be improved by:
 - increasing the integration time
 - enabling the recursive averaging function
2. When measuring very small phase shifts (less than 0.2°), the sign (positive or negative) of the measurement results cannot be definitely determined. If this causes a problem, refer to the phase measurement in the harmonic analysis.
3. For measuring phase, the input voltage should be greater than 5 % of full scale. An overload of the measurement channel does not negatively affect the obtainable accuracy.

Accuracy of the frequency measurement

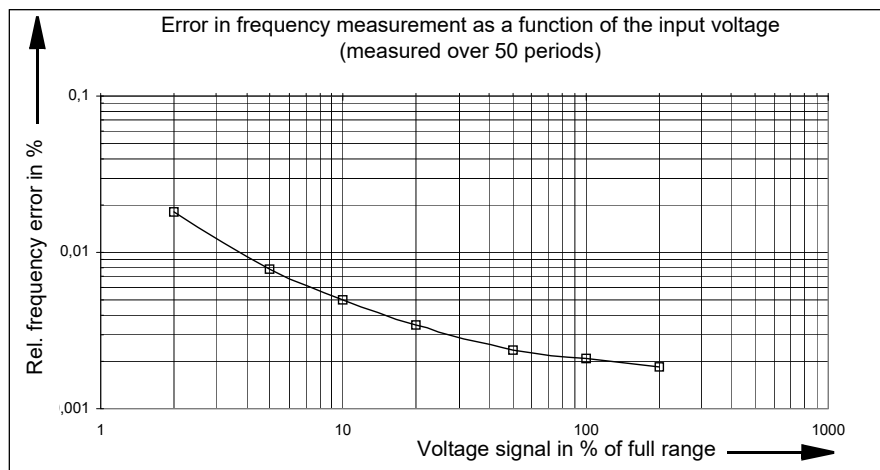

Conditions: integration time 1 s, measurement signal sinusoid

The maximum input frequency for the frequency measurement depends on the sampling rate.

Sampling rate and input frequency range:

Sampling rate	Input frequency range
28.44 kHz	10 Hz ... 1500 Hz
9.48 kHz	5 Hz ... 500 Hz
3.16 kHz	5 Hz ... 150 Hz

Conditions: Excitation greater than 10 % from measurement full scale, duty cycle 50 %.

Note: With the harmonic analysis, you can measure input frequencies up to 3.4 kHz.

Accuracy of power measurement

a) General

The power is calculated from 1 current channel and 1 voltage channel:

$$\text{Active power: } P = \frac{1}{T} \int_0^T u(t) \cdot i(t) dt \text{ [W]}$$

$$\text{Apparent power: } S = V_{\text{RMS}} \times I_{\text{RMS}} \text{ [VA]}$$

$$\text{Reactive power: } Q = \sqrt{S^2 - P^2} \cdot \text{sign}_Q \text{ [var]}$$

$$U_{\text{RMS}} = \sqrt{\frac{1}{T} \int_0^T u(t)^2 dt}, I_{\text{RMS}} = \sqrt{\frac{1}{T} \int_0^T i(t)^2 dt}$$

b) Accuracies

Conditions: integration time 1 s, measurement signal sinusoidal, excitation 10–100 %, accuracy references the apparent power, error of the current clamp is not taken into consideration

Sampling rates 28.44kHz, 9.48kHz, 3.16kHz:

Frequency range	Power	Accuracy ¹	
AC		Typical	Guaranteed
10 Hz ... 100 Hz	S	±0.3 %	±0.7 %
	P	±0.3 %	±0.7 %
	Q	±0.8 %	±2 %

Sampling rate 28.44kHz:

Frequency range	Power	Accuracy ¹	
AC		Typical	Guaranteed
10 Hz ... 2.2 kHz	S	+0.3 %/–1.2 %	±2.5 %
	P	+0.3 %/–1,2 %	±2.5 %
	Q	+0.8 %/–2.5 %	±3.5 %

$$1. \text{ Relative error: } \frac{\text{Actual} - \text{Expected}}{\text{Full scale}} \times 100 \%$$

S = Apparent power

P = Active power

Q = Reactive power

Sampling rate 9.48 kHz:

Frequency range	Power	Accuracy ¹	
AC		Typical	Guaranteed
10 Hz ... 750 Hz	S	+0.3 %/-0.7 %	±1.8 %
10 Hz ... 750 Hz	P	+0.3 %/-0.7 %	±1.8 %
10 Hz ... 750 Hz	Q	+0.8 %/-1.2 %	±2.5 %

Sampling rate 3.16 kHz:

Frequency range	Power	Accuracy ¹	
AC		Typical	Guaranteed
10 Hz ... 250 Hz	S	+0.3 %/-0.5 %	±1.3 %
10 Hz ... 250 Hz	P	+0.3 %/-0.5 %	±1.3 %
10 Hz ... 250 Hz	Q	+0.8 %/-1 %	±2.2 %

DC accuracy:

Power	Accuracy ¹	
P, S	Typical	Guaranteed
	±0.3 %	±0.9 %

1. Relative error: $\frac{\text{Actual} - \text{Expected}}{\text{Full scale}} \times 100 \%$

- S = Apparent power
- P = Active power
- Q = Reactive power

The accuracy specifications include linearity, temperature, aging drift, frequency and phase response.

c) Typical relative error as function of the excitation

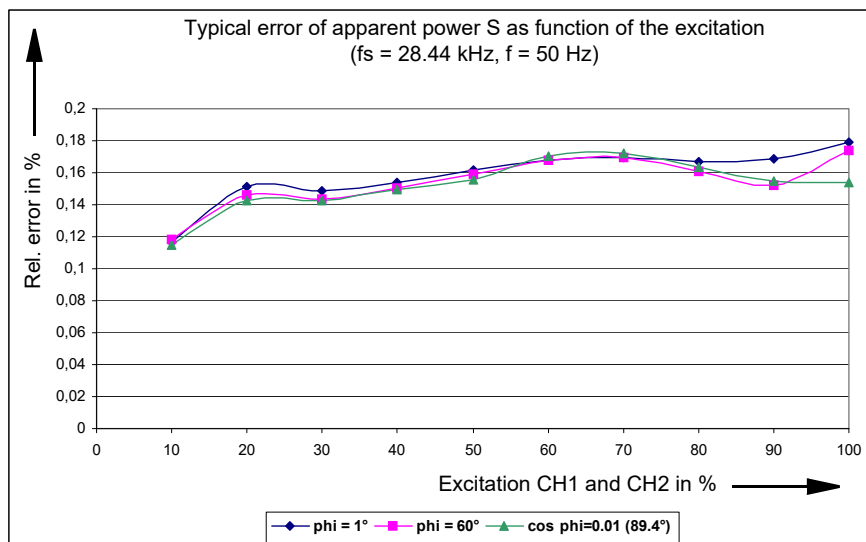

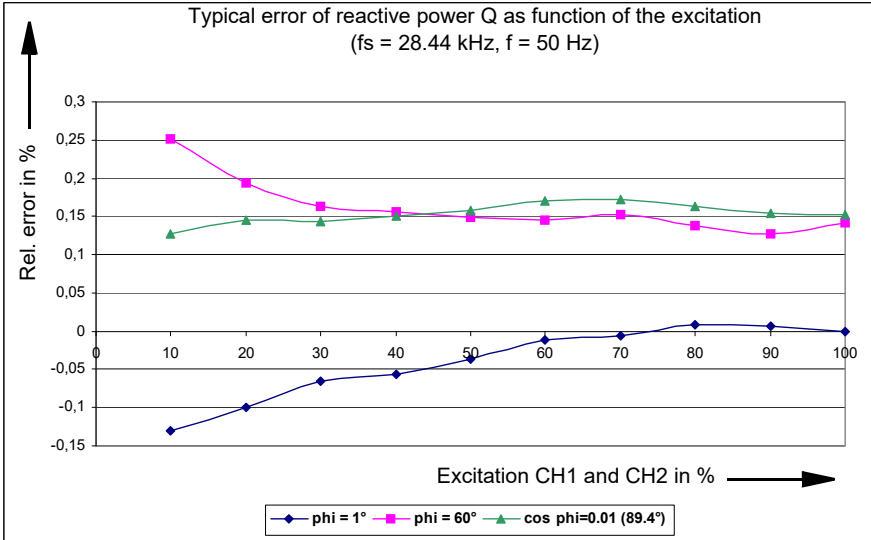
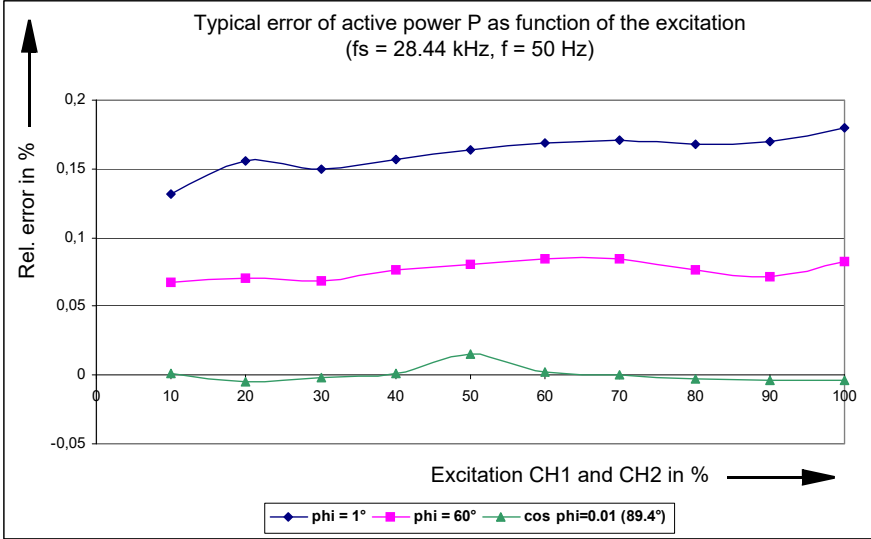

Conditions: integration time 1s, measurement signal sinusoid, sampling rate = 28.44 kHz, $f_{in} = 50$ Hz

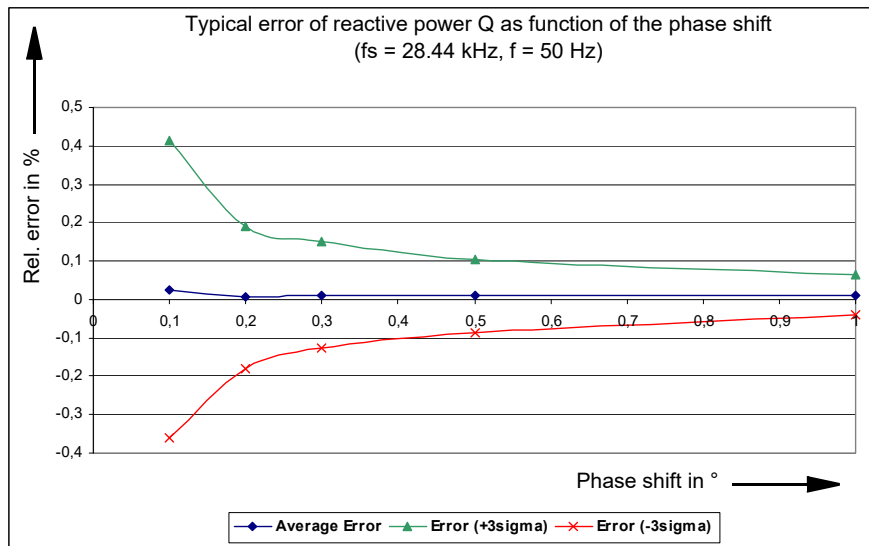

Conditions: integration time 1 s, measurement signal sinusoidal, sampling rate = 28.44 kHz, both channels with same excitation 70 %

The 3Sigma values are determined from 50 measurement values.

Note:

- For very small phase shifts (<0,3°) and small excitation (<10 %), too little integration time (<1 s) or sampling rate 3.16 kHz, the sign of the reactive power cannot definitely be determined.
- The accuracy of the power measurement depends primarily on the accuracy of the current clamp.

1.13.3 Harmonic analysis

This operating mode is designed for measuring stationary signals (for example, non-sinusoidal shape). The input signal is separated into fundamental and harmonic waves (Fourier analysis).

The following items are measured:

- frequency of the fundamental wave
- amplitude of the fundamental and harmonic waves
- phase shifts between the fundamental and harmonic waves (also from the different channels)

The input signals are captured. Finally, the calculation of the measurement items is carried out. During this time, the input signal is not taken into consideration.

Accuracy of the frequency measurement

The permitted input frequency range depends on the specified sampling rate:

Sampling rate	Input frequency range
28.44 kHz	49 Hz ... 3400 Hz
9.48 kHz	17 Hz ... 1100 Hz
3.16 kHz	5 Hz ... 380 Hz

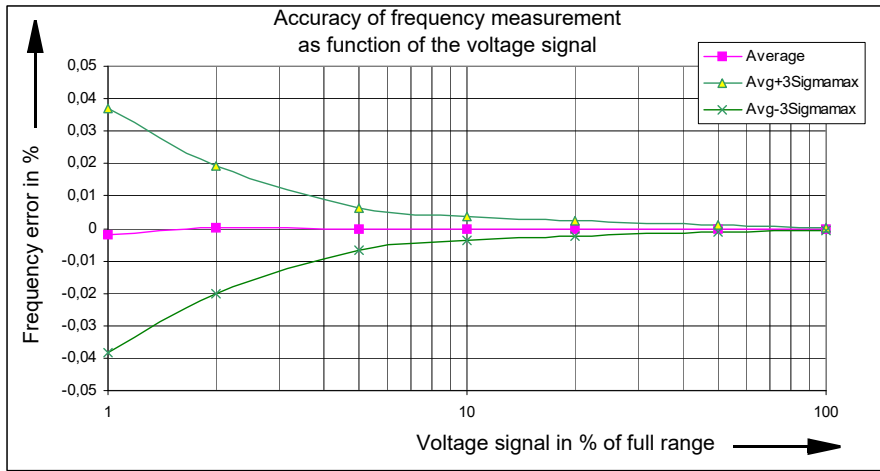

Conditions: sampling rate 9.48 kHz, $f_{in} = 20 \text{ Hz} \dots 1 \text{ kHz}$

Note: Through recursive averaging, the measurement uncertainty can be further reduced.

Accuracy amplitude measurement

The measurement values are given as effective values (RMS). The permitted input frequency range for the fundamental wave depends on the specified sampling rate. Sampling rate and input frequency range:

Sampling rate	Input frequency range
28.44 kHz	100 Hz (= f_{min}) ... 3200 Hz
9.48 kHz	30 Hz (= f_{min}) ... 1000 Hz
3.6 kHz	10 Hz (= f_{min}) ... 350 Hz

Applies to fundamental and harmonic waves in a specified frequency range; accuracy refers to full scale.

Sampling rate 28.44 kHz; measurement range 600 V, 100 V, 10 V, 1 V:

Frequency range	Accuracy	
	Typical	Guaranteed
$f_{min} \dots 1 \text{ kHz}$	$\pm 0.1 \%$	$\pm 0.3 \%$
$f_{min} \dots 10 \text{ kHz}$	$+0.1 \%/ -0.7 \%$	$\pm 1.1 \%$

Sampling rate 28.44 kHz; measurement range 100 mV:

Frequency range	Accuracy	
	Typical	Guaranteed
$f_{min} \dots 1 \text{ kHz}$	$\pm 0.2 \%$	$\pm 0.5 \%$
$f_{min} \dots 10 \text{ kHz}$	$+0.2 \%/ -1.0 \%$	$\pm 2.0 \%$

Sampling rate 9.48 kHz, 3.16 kHz; measurement range 600 V, 100 V, 10 V, 1 V:

Frequency range	Accuracy	
	Typical	Guaranteed
f_{\min} ... 100 Hz	±0.1 %	±0.3 %
f_{\min} ... 1 kHz	+0.1 %/−0.5 %	±0.8 %
f_{\min} ... 4 kHz (sampling rate = 9.48 kHz)	+0.1 %/−0.8 %	±1.2 %
f_{\min} ... 1.4 kHz (sampling rate = 3.16 kHz)	+0.1 %/−0.8 %	±1.2 %

Sampling rate 9.48 kHz, 3.16 kHz; measurement range 100 mV:

Frequency range	Accuracy	
	Typical	Guaranteed
f_{\min} ... 100 Hz	±0.15 %	±0.4 %
f_{\min} ... 1 kHz	+0.2 %/−0.5 %	±0.8 %
f_{\min} ... 4 kHz (sampling rate = 9.48 kHz)	+0.2 %/−1.0 %	±1.5 %
f_{\min} ... 1.4 kHz (sampling rate = 3.16 kHz)	+0.25 %/−1.0 %	±2.0 %

Accuracy of phase measurement

The permitted input frequency range for the fundamental wave depends on the specified sampling rate. Sampling rate and input frequency range:

Sampling rate	Input frequency range
28.44 kHz	100 Hz ... 3200 Hz
9.48 kHz	30 Hz ... 1000 Hz
3.16 kHz	10 Hz ... 350 Hz

Accuracy of phase measurement as function of the excitation:

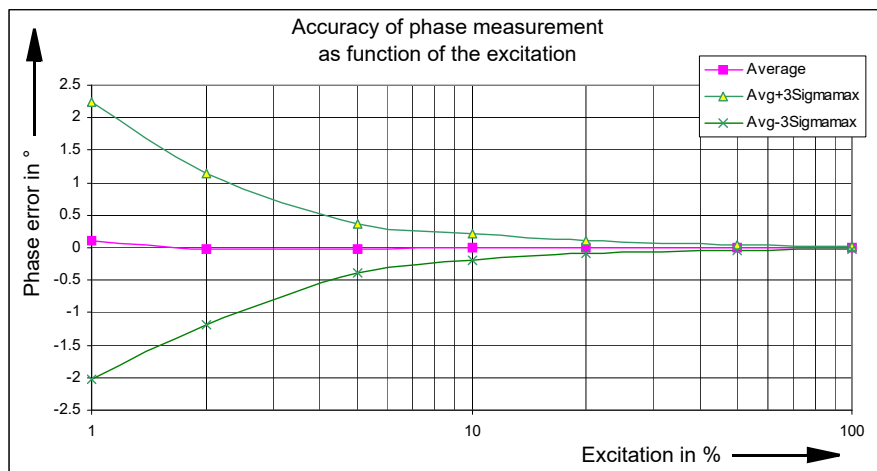

Conditions: sampling rate 9.48 kHz, $f_{in} = 50$ Hz

Note: Through recursive averaging, the measurement uncertainty can be further reduced.

1.13.4 Transient recording

In this operating mode, transient signals on up to 10 input channels can be synchronously recorded.

The recording starts whenever a predefined trigger condition is met. The selectable trigger conditions are:

- Trigger on threshold with positive or negative edge
- Combination of different power quality triggers (sag, swell, harmonic, frequency, frequency change, notch)

In addition, a time offset for the capture window relative to the trigger event can be specified. The trigger delay can be one of the following:

- positive (recording begins after the trigger event)
- negative (recording begins already before the trigger event)

Illustration of the relationship between trigger events, trigger delay, and recording time:

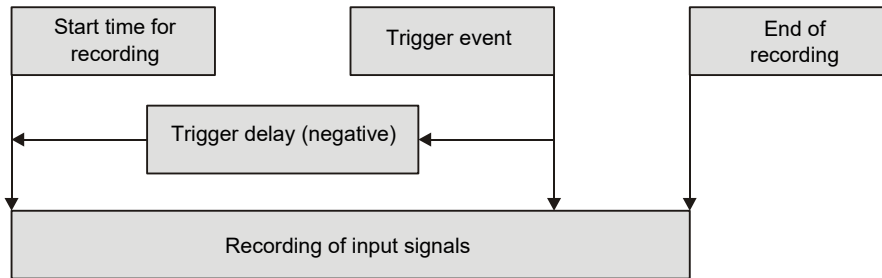

More details about triggering methods can be found in the OMICRON *Test Universe* help and in the practical examples of the *EnerLyzer* option.

The maximum recording time depends on the number of active channels and the sampling rate:

Number of active channels	Maximum recording time [s] at fs = 28.4 kHz	Maximum recording time [s] at fs = 9.48 kHz	Maximum recording time [s] at fs = 3.16 kHz
1	35.16 s	105.47 s	316.41 s
2	17.58 s	52.73 s	158.20 s
3	11.72 s	35.16 s	105.47 s
4	8.79 s	26.37 s	79.10 s
5	7.03 s	21.09 s	63.28 s
6	5.86 s	17.58 s	52.73 s
7	5.02 s	15.07 s	45.20 s
8	4.40 s	13.18 s	39.55 s
9	3.91 s	11.72 s	35.15 s
10	3.52 s	10.55 s	31.64 s
11 ¹	3.20 s	9.59 s	28.76 s

1. All binary inputs are stored as 1 channel.

Accuracy of a transient sampled input value

Measurement range	Accuracy	
	Typical	Guaranteed
600 V, 100 V, 10 V, 1 V	Error $<\pm 0.2\%$	Error $<\pm 0.5\%$
100 mV	Error $<+0.3\%$	Error $<\pm 0.6\%$

The accuracy data are full-scale errors.