



# INSTRUCTION MANUAL

ENGLISH



## CAPO 2.5 / CAPO 12

CAPACITANCE AND POWER FACTOR  
METER

# Contents

<b>1 Safety Precautions</b>	<b>6</b>
1.1 Safe operation.....	6
1.2 Ground the Instrument.....	6
1.3 Operator qualifications and safety standards.....	7
1.4 Measuring cable management and connection.....	8
1.5 Before applying power.....	8
1.6 Keep away from live circuits.....	9
1.7 Do not operate in an explosive atmosphere.....	9
1.8 Do not substitute parts or modify Instrument.....	9
1.9 Transportation and Lifting.....	9
<b>2 CAPO 2.5</b>	<b>10</b>
2.1 Unpacking.....	10
2.2 Technical Specifications CAPO 2.5.....	11
2.3 Measurement Parameters CAPO 2.5.....	12
<b>3 CAPO 12</b>	<b>14</b>
3.1 Unpacking.....	14
3.2 Technical Specifications CAPO 12.....	15
3.3 Measurement Parameters CAPO 12.....	16
<b>4 Introduction</b>	<b>18</b>
4.1 General.....	18
4.2 Advantages & Features.....	20
4.3 System Details.....	20
<b>5 Quick Start Guide</b>	<b>21</b>
5.1 Connection.....	21
5.2 Instrument operation.....	21
<b>6 Power factor / <math>\tan \delta</math> measurements</b>	<b>23</b>
6.1 Definitions.....	23
6.1.1 Dissipation factor $\tan \delta$ .....	24
6.1.2 Power Factor (PF) $\cos \varphi$ .....	25
6.2 Background.....	26
6.2.1 Imperfect dielectric.....	26
6.2.2 Equivalent circuits.....	27
6.2.3 Conversion series- parallel-replacement circuit diagram.....	29
6.2.3.1 Simplifications for small Dissipation / Power Factor.....	31
6.2.4 Conversion capacitances to inductances.....	32
<b>7 Operation Elements</b>	<b>33</b>
7.1 CAPO 2.5.....	33
7.2 CAPO 12.....	36
<b>8 Operating Menu</b>	<b>39</b>

8.1 Menu Structure.....	39
8.2 Main Menu.....	40
8.2.1 Main Menu Screen.....	40
8.2.1.1 Safety-Switch.....	43
8.2.1.2 Earth connection.....	43
8.2.1.3 Test object.....	44
8.2.1.4 Time.....	44
8.2.1.5 Battery Symbol.....	45
8.2.2 Measurement Mode.....	46
8.2.3 Caption.....	47
8.2.4 Measurement frequency.....	48
8.2.5 Measurement voltage.....	50
8.2.6 Start a measurement.....	51
8.2.6.1 Single measurement.....	52
8.2.6.2 Multi measurement.....	52
8.2.6.3 Continuous measurement.....	53
8.2.7 Setup.....	55
8.2.7.1 General.....	56
8.2.7.1.1 License.....	56
8.2.7.1.2 About.....	57
8.2.7.1.3 Clock.....	57
8.2.7.1.4 Cursor.....	57
8.2.7.1.5 Update.....	58
8.2.7.1.6 Language.....	58
8.2.7.1.7 Service.....	59
8.2.7.2 Operator.....	59
8.2.7.3 Oil Correction Table.....	60
8.2.7.4 Dissipation factor.....	61
8.2.7.5 Quality Assistant.....	61
8.2.7.6 Printer.....	62
8.2.7.7 Colour.....	62
8.3 Results and data structure.....	63
8.3.1 New.....	63
8.3.1.1 New test object.....	64
8.3.1.2 Load from Archive.....	64
8.3.1.3 New Measurement.....	65
8.3.2 Info.....	65
8.3.3 Archive.....	65
8.3.3.1 Info.....	66
8.3.3.1.1 Diagram.....	67
<b>9 Measurement Modes</b> .....	<b>69</b>
9.1 Overview.....	69
9.2 UST Ungrounded Specimen Test.....	71
9.2.1 UST A.....	72
9.2.2 UST B.....	72
9.2.3 UST A + B.....	73
9.3 GST.....	74
9.3.1 GST A + B.....	74
9.4 GSTg.....	75
9.4.1 GSTg A.....	76
9.4.2 GSTg B.....	76

9.4.3 GSTg A + B.....	77
9.5 Xfrmr.....	78
9.5.1 HL HV.....	78
9.5.2 HL LV.....	78
9.5.3 HLT HV.....	79
9.5.4 HLT LV.....	79
9.5.5 HLT TV.....	80
9.6 Multi.....	81
9.7 Excitation current Iexci.....	82
<b>10 Bushing Test</b>	<b>84</b>
10.1 Bushing Overall test.....	86
10.2 Bushing main insulation test.....	87
10.3 Bushing tap insulation test.....	88
10.4 Bushing hot collar test.....	89
<b>11 Interfaces</b>	<b>90</b>
11.1 Hardware.....	90
11.1.1 RS 323.....	90
11.1.2 USB.....	90
11.1.3 Safety.....	91
11.1.4 Temp.....	92
<b>A Raytech T-Base</b>	<b>95</b>
A.1 T-Base Lite.....	95
A.2 T-Base Pro.....	95
<b>B System Update</b>	<b>96</b>
<b>C Software Development Kit (SDK)</b>	<b>97</b>
<b>D Command Syntax</b>	<b>98</b>
D.1 Raytech USB/Serial Port Driver.....	98
D.2 Command Syntax.....	98
D.3 Answer-codes.....	98
D.3.1 Synchronous Answers.....	98
D.3.2 Asynchronous Answer.....	99
D.3.3 Serial Interface.....	99
D.4 USB Interface.....	99
<b>E USB Printer Info</b>	<b>100</b>
E.1 Printer Requirements.....	100
E.2 Suggested Printers.....	100
<b>F Service Mode</b>	<b>101</b>
F.1 Calibrate Touchscreen.....	101
F.2 Show Ground Warning.....	102
F.3 CSV Separator.....	102
F.4 Raytech USB Driver.....	103
F.5 Show Series Values.....	103
F.6 Oil Correction Table.....	104
<b>G Error Messages</b>	<b>106</b>

<b>H Trouble Shooting</b>	<b>108</b>
H.1 Touch Panel does not work.....	109
H.2 USB Memory Stick does not work.....	109
<b>I Warranty Conditions</b>	<b>110</b>
I.1 Limitation of Warranty.....	110
I.2 Arbitration.....	111
<b>J Contacts</b>	<b>112</b>
<b>K Index</b>	<b>113</b>

# 1 Safety Precautions

The following safety precautions must be observed during all phases of operation, service and repair of this instrument. By purchasing this equipment the purchaser assumes all liability for the operation and use of this equipment. The intended use of the instrument, its design and manufacture, is to be conducted within the precautions or other specific warnings located within this manual. Failure to comply with these precautions and other specific warnings violates the safety standards of design, manufacture, and intended use. Raytech assumes no liability for the operation and use of this equipment.

## 1.1 Safe operation

Only qualified, knowledgeable persons should be permitted to or attempt to operate this test equipment. All test personnel should fully familiarize themselves with the correct application and operation of this and all test equipment prior to operation. Persons directly and indirectly engaged in the operation of this test equipment should keep clear of all high voltage apparatus while conducting tests and measurements.



### **WARNING !**

Never connect the Instrument to an energized Transformer!

## 1.2 Ground the Instrument

To minimize shock hazard, the Ground Terminal on the instrument must be properly connected to an Earth grounded point. In many cases, the quality of the safety ground terminal provided by the power cord does not fulfil the safety requirements.

Also the power cord supplied with the equipment must be connected to an electrical receptacle with an electrical ground (safety earth ground).



### **WARNING !**

Non-grounded Instruments are dangerous and may cause damage to personnel and to the Instrument.

### 1.3 Operator qualifications and safety standards

Before performing any test with this instrument, read this user manual and observe all safety precautions indicated.



#### **HIGH VOLTAGE !**

Hazardous voltage may result in severe injury or death!

Be aware that Safety is the responsibility of the user!

Corrective maintenance must be performed by qualified personnel who are familiar with the construction and operation of the test set and the hazards involved.

Raytech AG refuses to accept any responsibility for consequential or direct damage to persons or goods due to non-observance of instructions contained herein or due to incorrect use of the instrument.



#### **CAUTION !**

The FIRST cable you have to connect to earth ground is always the Safety GND. This is also the LAST cable to disconnect! Any interruption of the grounding connection can create an electric shock hazard.

Never disconnect the high voltage or the low voltage test cables from either the terminals of the test specimen or the instrumental side, unless the CAPO is in safe mode.

The CAPO and the object to which it is connected are possible sources of high voltage electrical energy and all persons making or assisting in tests must use all practical safety precautions to prevent contact with energized parts of the test set and related circuits. Persons actually engaged in the test must stand clear of all parts of the complete high voltage circuit, including all connections, unless the test set is deenergized and all parts of the test circuit are grounded.



### **WARNING !**

Before operating the instrument, be sure you have read and understood fully the operating instructions. This instrument is connected to hazardous voltages. It is the responsibility of the user to ensure that the system is operated in a safe manner.

One must always expect that under certain circumstances a dangerous high voltage can be applied!

Working on HV devices is extremely dangerous. Measurements must be carried out only by qualified, skilled and authorized personnel. Before starting to work, clearly establish the responsibilities. Personnel receiving training, instructions, directions or education on the measurement setup must be under constant supervision of an experienced operator while working with the equipment. The measurement must comply with the relevant national and international safety standards listed below:

- EN 50191 (VDE 0104) "Erection and Operation of Electrical Equipment"
- EN 50110-1 (VDE 0105 Part 100) "Operation of Electrical Installations"
- IEEE 510 "Recommended Practices for Safety in High-Voltage and High-Power Testing"
- LAPG 1710.6 NASA "Electrical Safety"

Moreover, additional relevant laws and internal safety standards have to be followed.

## **1.4 Measuring cable management and connection**

The HV Cable and the 2 measurement cables A and B are shielded. On the one hand because of the safety and on the other because of the measuring accuracy.

Take care that no jacket of the cable touches the high voltage parts because of partial discharge or flashover!



### **CAUTION !**

Note that no cable touches the high voltage parts with the jacket!

## **1.5 Before applying power**

Read this manual carefully before operating the system. The CAPO 2.5 and the CAPO 12 operates within a wide range of power input from 85Vac to 264Vac and 47Hz to 63Hz with automatic ranging.



## **1.6 Keep away from live circuits**

Operating personnel must not remove instrument covers. Component replacement and internal repairs must be made by qualified service personnel. Do not replace components or service this instrument with the power cable connected. To avoid injuries, always discharge circuits, disconnect power and remove external voltage sources before touching components.

## **1.7 Do not operate in an explosive atmosphere**

Do not operate the instrument in the presence of flammable gases or fumes.

## **1.8 Do not substitute parts or modify Instrument**

Because of the danger of introducing additional hazards, do not install substitute parts or perform any unauthorized modification to the instrument. Return the instrument to a Raytech service department for service to ensure proper operation and that safety features are maintained.

Instruments, which appear damaged or defective, should be made inoperative and secured against unintended operation until they can be repaired by qualified service personnel.

## **1.9 Transportation and Lifting**

Especially the CAPO 12 is a heavy instrument. Do not lift it alone. It is equipped with wheels for easy transport.

## 2 CAPO 2.5

### 2.1 Unpacking



The Instrument



Power cord (dependent upon country of distribution)



2 Paper Rolls



HV Cable 1 x 10m



Measurement Cables  
2 x 10m



Cable bag



Safety-GND Cable 1 x 10m



HV-GND Cable 1 x 10m



Safety-Switch 1 x 2m



Instruction Manual



USB Stick

If any of the above items are missing or damaged, contact your local representative or Raytech Switzerland immediately.

Optional test leads may be ordered (other than shown).

## 2.2 Technical Specifications CAPO 2.5<sup>1</sup>

The CAPO 2.5 is specially designed for fast and easy field measurement with the well known high precision and quality of Raytech.

Type	CAPO 2.5
Size	L: 521 mm (20.5") W: 432 mm (17") H: 216 mm (8.5")
Weight	22.2 kg (48.9 lbs.)
Input Power	85-264 VAC (250 W max.) 47-63 Hz, automatic ranging
Battery	Li-Ion battery pack
Output Voltage	up to 2500V AC
Output Frequency	10Hz – 400Hz
Test Current	up to 200mA
Output Power	500VA
Panel Display	Color LCD with back lighting and touch screen.
Front Panel	Sealed anodized.
Interface	2 x USB 2.0 (1 host / 1 device) and 9 Pin RS232 serial
Memory Storage	Stores up to 10000 complete test results.
Operating Temperature	-10°C to 60°C
Storage Temperature	-20°C to 70°C

<sup>1</sup> Specifications are subject to change without notice

## 2.3 Measurement Parameters CAPO 2.5

Measured values: Dissipation Factor  $\tan \delta$ , Power Factor  $\cos \varphi$ , Capacitance, Inductance, Quality Factor, Power (Watts), Power<sub>@10kV</sub>, Resistance

	Range	Resolution	Accuracy
Dissipation Factor $\tan \delta$	0 ... 0.1 0.1 ... 1 > 1	$1 \times 10^{-5}$ $1 \times 10^{-4}$ 3 Digits	$\pm 0.5\% \text{ Rdg} \pm 1 \times 10^{-4}$ $\pm 0.5\% \text{ Rdg} \pm 1 \times 10^{-4}$ $\pm 0.5\% \text{ Rdg}$
Power Factor $\cos \varphi$	0 ... 0.1 0.1 ... 1	$1 \times 10^{-5}$ $1 \times 10^{-4}$	$\pm 0.5\% \text{ Rdg} \pm 1 \times 10^{-4}$ $\pm 0.5\% \text{ Rdg} \pm 1 \times 10^{-4}$
Capacitance  $C_{max} = \frac{I_{max}}{U \cdot 2 \cdot \pi \cdot f}$	50Hz 0.00pF ... 254nF @ 2.5kV 0.00pF ... 1.3μF @ 500V  60Hz 0.00pF ... 212nF @ 2.5kV 0.00pF ... 1.1μF @ 500V	0.01pF or 5 Digits	$\pm 0.3\% \text{ Rdg} \pm 0.3\text{pF}^1$
Test Voltage	up to 2'500V <sub>rms</sub> (45 ... 400Hz)  f < 45Hz: $U_{outmax} = \frac{2500 \text{ V}}{45 \text{ Hz}} \cdot f$	1V	$\pm 0.5\% \text{ Rdg} \pm 1\text{V}$
Test Current	up to 200mA <sub>rms</sub>	0.1μA or 4 Digits	$\pm 0.3\% \text{ Rdg} \pm 1\mu\text{A}$
Output Power	0 ... 500VA		
Output Frequency	10Hz - 400Hz	0.1%	$\pm 0.01\%$

1 >500V

	<b>Range</b>	<b>Resolution</b>	<b>Accuracy</b>
Inductance <sup>1</sup>  <div style="border: 1px solid black; padding: 5px; width: fit-content; margin: 10px auto;"> <math display="block">L_{min} = \frac{U}{I \cdot 2 \cdot \pi \cdot f}</math> </div>	50Hz 40H ... 100'000H @ 2.5kV 8H ... 100'000H @ 500V  60Hz 33H ... 70'000H @ 2.5kV 6.6H ... 70'000H @ 500V	0.1mH or 4 Digits	± 0.3% Rdg

<sup>1</sup> For more information see chapter 6.2.4 Conversion capacitances to inductances on page 32

### 3 CAPO 12

#### 3.1 Unpacking



The Instrument



Power cord (dependent upon country of distribution)



2 Paper Rolls & 2 Fuses



HV Cable 1 x 10m



Measurement Cables  
2 x 10m



Cable bag



Safety-GND Cable 1 x 10m



HV-GND Cable 1 x 10m



Safety-Switch 1 x 2m



Instruction Manual



USB Stick

If any of the above items are missing or damaged, contact your local representative or Raytech Switzerland immediately.

Optional test leads may be ordered (other than shown).

### 3.2 Technical Specifications CAPO 12<sup>1</sup>

The CAPO 12 is specially designed for fast and easy field measurement with the well known high precision and quality of Raytech.

Type	CAPO 12
Size	L: 627 mm (24.7") W: 475 mm (18.7") H: 292 mm (11.5")
Weight	36.9 kg (81 lbs.)
Input Power	85-264 VAC, 47-63 Hz, automatic ranging
Output Voltage	up to 12000V AC
Output Frequency	10Hz – 400Hz
Test Current	up to 200mA
Output Power	0 ... 2'400VA (400W)
Panel Display	Color 5.7" LCD with back lighting and touch screen.
Front Panel	Sealed anodized.
Interface	2 x USB 2.0 (1 host / 1 device) and 9 Pin RS232 serial
Memory Storage	Stores up to 10000 complete test results.
Operating Temperature	-10°C to 60°C
Storage Temperature	-20°C to 70°C

<sup>1</sup> Specifications are subject to change without notice

### 3.3 Measurement Parameters CAPO 12

Measured values: Dissipation Factor  $\tan \delta$ , Power Factor  $\cos \varphi$ , Capacitance, Inductance, Quality Factor, Power (Watts), Power<sub>@10kV</sub>, Resistance

	Range	Resolution	Accuracy
Dissipation Factor $\tan \delta$	0 ... 0.1 0.1 ... 1 > 1	$1 \times 10^{-5}$ $1 \times 10^{-4}$ 3 Digits	$\pm 0.5\% \text{ Rdg} \pm 1 \times 10^{-4}$ $\pm 0.5\% \text{ Rdg} \pm 1 \times 10^{-4}$ $\pm 0.5\% \text{ Rdg}$
Power Factor $\cos \varphi$	0 ... 0.1 0.1 ... 1	$1 \times 10^{-5}$ $1 \times 10^{-4}$	$\pm 0.5\% \text{ Rdg} \pm 1 \times 10^{-4}$ $\pm 0.5\% \text{ Rdg} \pm 1 \times 10^{-4}$
Capacitance  $C_{max} = \frac{I_{max}}{U \cdot 2 \cdot \pi \cdot f}$	50Hz 0.00pF ... 53nF @ 12kV 0.00pF ... 254nF @ 2.5kV 0.00pF ... 1.3μF @ 500V  60Hz 0.00pF ... 44nF @ 12kV 0.00pF ... 212nF @ 2.5kV 0.00pF ... 1.1μF @ 500V	0.01pF or 5 Digits	$\pm 0.3\% \text{ Rdg} \pm 0.3\text{pF}^1$
Test Voltage	up to 12'000V <sub>rms</sub> (45 ... 400Hz)  f < 45Hz: $U_{outmax} = \frac{12000V}{45Hz} \cdot f$	1V (<2900V) 10V (>2900V)	$\pm 0.5\% \text{ Rdg} \pm 1V$
Test Current	up to 200mA <sub>rms</sub>	0.1μA or 4 Digits	$\pm 0.3\% \text{ Rdg} \pm 1\mu A$
Output Power	0 ... 2400VA <sup>2</sup>		
Output Frequency	10Hz - 400Hz	0.1%	$\pm 0.01\%$



	Range	Resolution	Accuracy
Inductance <sup>3</sup>  $L_{min} = \frac{U}{I \cdot 2 \cdot \pi \cdot f}$	50Hz 191H ... 100'000H @ 12kV 40H ... 100'000H @ 2.5kV 8H ... 100'000H @ 500V  60Hz 159H ... 70'000H @ 12kV 33H ... 70'000H @ 2.5kV 6.6H ... 70'000H @ 500V	0.1mH or 4 Digits	± 0.3% Rdg

1 >500V

2 Max 400W

3 For more information see chapter 6.2.4 Conversion capacitances to inductances on page 32

## 4 Introduction

### 4.1 General

The measuring instrument CAPO 2.5 and CAPO 12 are a new Capacitance and Power Factor Test Sets developed by Raytech Engineers. Both are built into a portable rugged case, making it perfect for field use, specially designed for fast and easy field measurement, with the well known high precision and quality of Raytech.

CAPO 2.5 is battery operated and has an output voltage of 2'500V. CAPO 12 has an output voltage of 12'000V.

Both test set measures dissipation factor ( $\tan \delta$ ), power factor ( $\cos \varphi$ ), capacitance, inductance, quality factor, resistance, excitation current and power (watts). Built to stand up to the harsh conditions of field testing, this instruments provide reliable test results in any situation.

The high power variable frequency design generates its own test signal independent of line frequency quality and the hardware design uses the latest technology available for digital filtering of the response signal.

**Ease of use:** This intelligent systems have an easy to use operation screen which allows quick selection of the voltage, frequency and measurement mode. Both systems incorporate a touchscreen which allows the user easy access to change or activate a feature.

**Impressive Accuracy:** The instruments have a high precision, fully automatic, multi-microprocessor based architecture. The systems are designed for highly accurate readings on-site with laboratory precision.

**Built in Standard Capacitor:** No external Capacitor is necessary to do precision measurement.

**Wide range:** The frequency and the voltage is user selectable from 10Hz to 400Hz, up to 2'500V (CAPO2.5) or up to 12'000V (CAPO 12). Results are reported on the easy-to-read color LCD display and can be stored or printed.

**Compact Design:** Both CAPO are available in its own rugged waterproof field case. The CAPO 12 is equipped with wheels for easy transport.



#### INFO:

The CAPO case is a waterproof design. A pressure regulator activates when the case is opened to compensate for atmospheric pressure changes.

**Simple Maintenance:** There is no maintenance required. There is no calibration procedure (no potentiometers to turn). This is due to the utilization of high precision components in the design.

**Advanced Protection:** Upon powering on, the system initializes itself with a self-calibrating, circuit checking sequence. If any problems are detected during this initialization period, or during operation, the operator is immediately notified. The system constantly monitors the condition when turned on. This is one of the many reasons we can extend our warranty to 2 years.

## 4.2 Advantages & Features

- Built-in Standard Capacitor
- Power Factor / Tan  $\delta$  reading
- Test Frequency 10Hz to 400Hz
- Internal thermal printer
- Microprocessor based system with internal storage for over 10000 test results
- Data exchange via USB Key or USB / RS232 Connection
- Storage and Printing of test results
- Complete automatic calibration system and system diagnostics
- Temperature channel
- Standard USB 2.0 & RS232 (serial) Interface
- Color LCD with backlighting and touch screen
- Panel mounted Emergency Stop Switch
- Mounted in rugged case for field testing
- 2 Years standard warranty
- High voltage excitation current features
- Multiple frequency measurements
- Reactance and quality factor reading

## 4.3 System Details

### System Check:

The system is designed to be used with AC Voltage power sources between 85 to 264VAC, 47 to 63Hz. The CAPO performs a self-check each time that it is powered on. The User should always visually inspect all connectors, cables and devices to be measured to avoid any safety issues.

## 5 Quick Start Guide

### 5.1 Connection

The FIRST cable you have to connect and lead to earth ground, is always the Safety GND!  
 Afterwards connect the HV-GND, the HV-cable and the measurement cable to the test object.  
 Finally, connect the Safety-Switch to the Instrument.

### 5.2 Instrument operation



#### **WARNING !**

Hazardous voltage may result in severe injury or death!

#### 1. Power on the instrument<sup>1</sup>

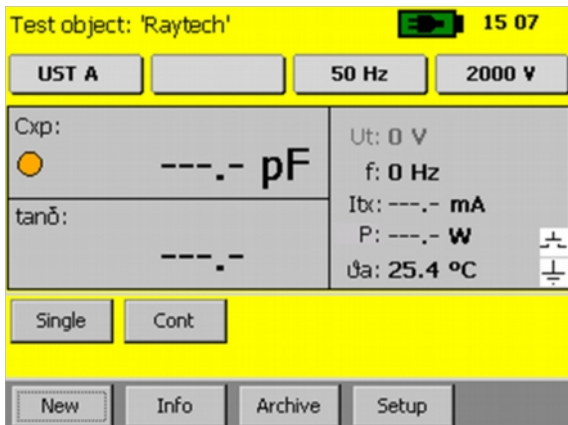

#### 2. Select voltage and frequency

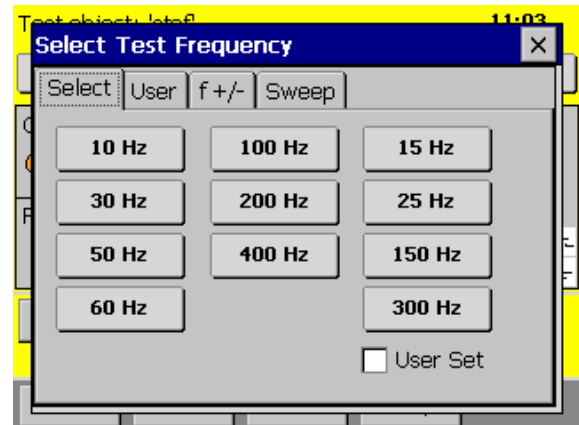

<sup>1</sup> The battery symbol on the top of the screen is only available in the CAPO 2.5

3. Press the Safety Switch and select **Single** or **Cont** (Continuous) to start

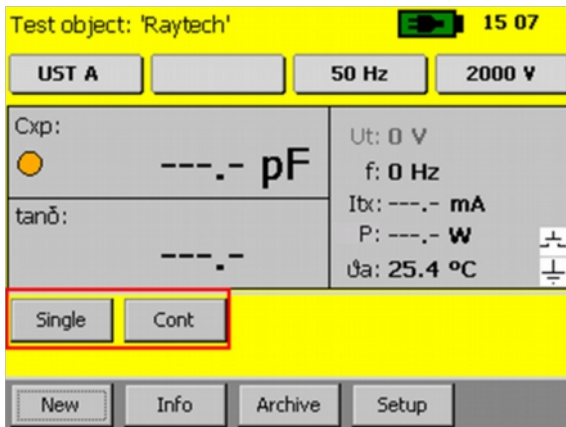

4. Get the results you want by selecting the measurement mode (also possible during the measurement)

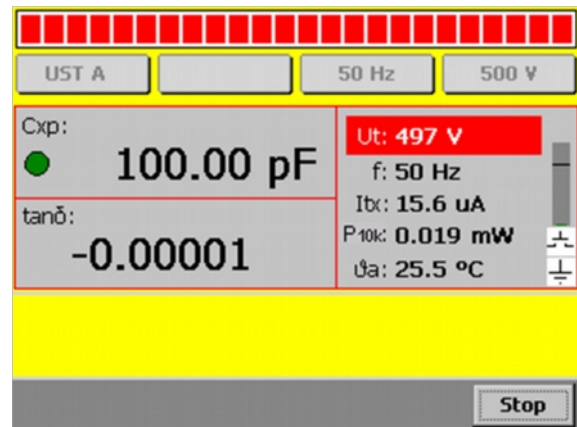

## 6 Power factor / $\tan \delta$ measurements<sup>1</sup>

### 6.1 Definitions

IEC defines the power factor  $\cos \varphi$  as the ratio between the absorbed active power to the absolute value of the reactive power. This corresponds to  $\tan \delta$ .

The picture below shows the definition of dielectric variables  $\tan \delta$  (dissipation factor) and  $\cos \varphi$  (insulation power factor) in an equivalent parallel circuit.

Example: Equivalent parallel circuit

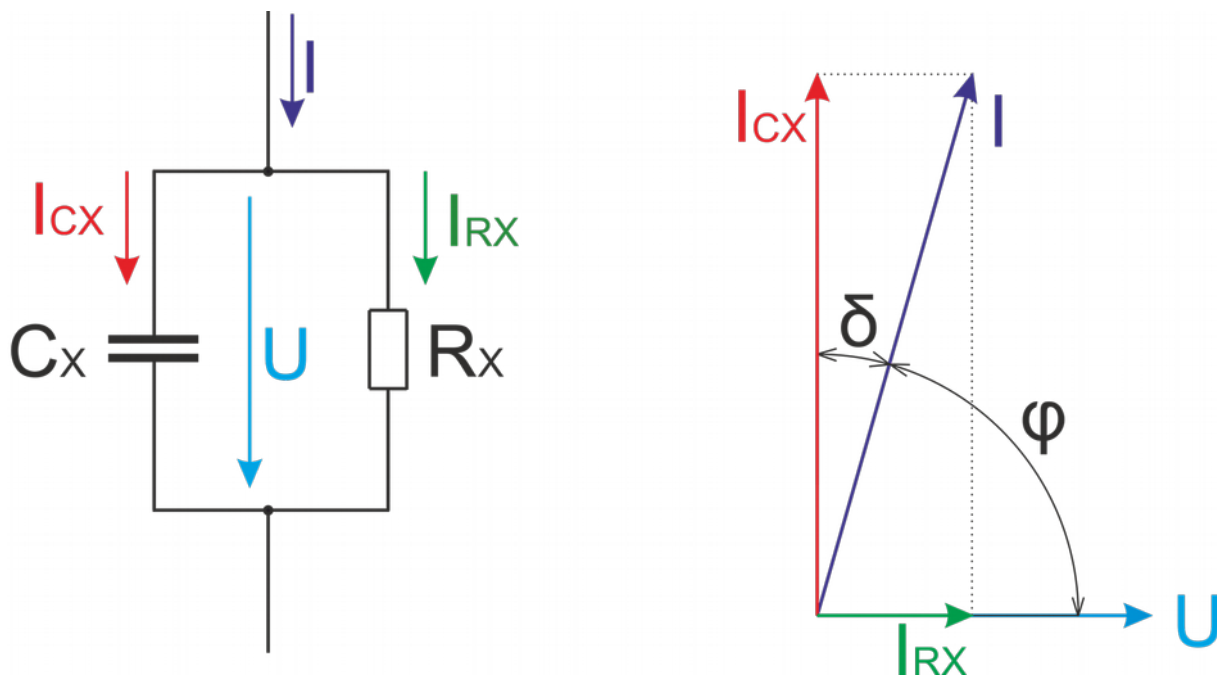

<sup>1</sup> According to IEEE Std C57.152-2013

### 6.1.1 Dissipation factor $\tan \delta$

It is the tangent of loss angle  $\delta$

$$\tan \delta = \frac{P}{|Q|}$$

$$\tan \delta = \frac{P}{|Q|} = \frac{I_{RX}}{I_{CX}} = \frac{\sin \delta}{\sqrt{1 - \sin^2 \delta}} = \frac{\cos \varphi}{\sqrt{1 - \cos^2 \varphi}} = \tan(\arcsin(\cos \varphi))$$

where:

P Real Power [W]

Q Reactive Power [VAR]

$I_{RX}$  current through resistance [A]

$I_{CX}$  current through capacitance [A]



### 6.1.2 Power Factor (PF) $\cos \varphi$

It is the Cosine of the phase angle  $\varphi$  or the sine of the loss angle  $\delta$

$$PF = \cos \varphi = \frac{P}{S}$$

$$\cos \varphi = \frac{P}{S} = \frac{P}{\sqrt{P^2+Q^2}} = \frac{I_{RX}}{I} = \sin \delta = \frac{I_{RX}}{\sqrt{I_{RX}^2+I_{CX}^2}} = \frac{\tan \delta}{\sqrt{1+\tan^2 \delta}} = \sin(\arctan(\tan \delta))$$

where:

P Real Power [W]

S Apparent Power [VA]

I total current [A]

$I_{RX}$  current through resistance [A]

$I_{CX}$  current through capacitance [A]

**Info:**

The CAPO is able to display either dissipation factor  $\tan \delta$  or power factor  $\cos \varphi$  based on the users choice.

In cases where the angle is very small, dissipation factor  $\tan \delta$  practically equals power factor  $\cos \varphi$ .

Have a look at chapter 6.2.3.1 Simplifications for small Dissipation / Power Factor on page 31.

## 6.2 Background

Insulation power factor (PF) is one of the most common tests performed on transformers, regulators, reactors, bushings, and other supported equipment and should be conducted as part of factory, acceptance, diagnostic and routine assessment. Though dielectrics have inherent losses due to construction materials, PF measurement is most effective at detecting the relative levels of moisture and contamination. Evaluation of the capacitance measurement is effective in detecting physical defects that lead to changes in the dielectric's geometry.

### 6.2.1 Imperfect dielectric

The properties of true dielectric insulations are often simplified and expressed as imperfect dielectrics. An imperfect dielectric is a dielectric where the energy necessary to create an electric field is not returned to the electric field when the energy is removed. The energy is converted into heat in the dielectric. Conversely, a perfect dielectric has zero conductivity, and there are no absorption effects. A high vacuum is an example of a perfect dielectric. Most dielectrics tested are considered imperfect dielectrics due to the presence of moisture, contaminants, and other inherent polar molecules.

## 6.2.2 Equivalent circuits

The two common methods of representing the imperfect dielectric are the series and parallel circuit. These two circuits include two elements, a capacitor and a resistor.

The resistor represents the loss component of the insulation, while the capacitor represents the geometric and physical properties, such as the dielectric constant.

The figure below displays the two common methods of representing the imperfect dielectric.

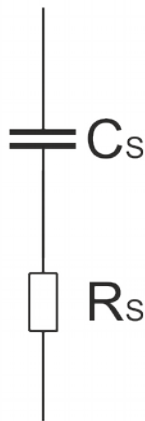

Serial Circuit

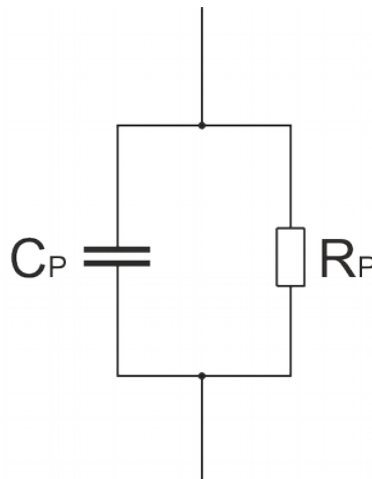

Parallel Circuit

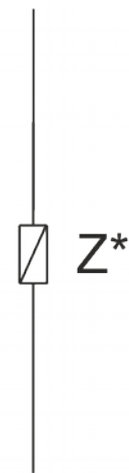

Impedance  
\*complex

$$R_S + \frac{1}{j\omega C_S} = \frac{R_P \frac{1}{j\omega C_P}}{R_P + \frac{1}{j\omega C_P}} = Z$$

where:

$C_S$	serial Capacitance [F]
$C_P$	parallel Capacitance [F]
$R_S$	serial Resistance [ $\Omega$ ]
$R_P$	parallel Resistance [ $\Omega$ ]
$Z$	Impedance (complex) [ $\Omega$ ]
$\omega$	angular frequency [ $s^{-1}$ ] $\omega=2*\pi*f$

Either circuit is adequate for explaining the effects of PF within a dielectric specimen. In the series circuit,  $R_s$  represent the series AC resistance. The parallel circuit shows  $R_p$  as the equivalent parallel resistance. Though both can be used in discussing and defining PF, the **parallel circuit** is the most common. In both cases, the resistance represents the presence of moisture, contaminants, lossy partial discharge (PD) activity, and inherent polar materials.



**INFO:**

**The CAPO uses the parallel circuit as model.**

Have a look in the attachment “F.5 Show Series Values” on page 106 if you would like to see the series values.

### 6.2.3 Conversion series- parallel-replacement circuit diagram

The following formulas are helpful for the conversion of the two models:

$$C_s = C_p * (1 + \tan^2 \delta)$$

$$C_p = \frac{C_s}{1 + \tan^2 \delta}$$

$$C_s = \frac{R_p^2 * \omega^2 * C_p^2 - 1}{R_p^2 * \omega^2 * C_p} = C_p * (1 + \tan^2 \delta)$$

$$C_p = \sqrt{\frac{R_p - R_s}{R_s * R_p^2 * \omega^2}} = \frac{C_s}{1 + \tan^2 \delta}$$

$$R_s = \frac{|Z^2|}{R_p} = \frac{R_p * X_p^2}{R_p^2 + X_p^2} = \frac{R_p}{R_p^2 * \omega^2 * C_p^2 + 1} = \frac{R_p * \tan^2 \delta}{1 + \tan^2 \delta} = \frac{\tan \delta}{\omega * C_s}$$

$$R_p = \frac{|Z^2|}{R_s} = \sqrt{\frac{X_p^2 * X_s}{X_p - X_s}} = \frac{1}{\omega * C_p * \tan \delta} = R_s * \left( \frac{1 + \tan^2 \delta}{\tan^2 \delta} \right)$$

$$Z = X_s * \sqrt{1 + \tan^2 \delta}$$

$$Z_p = Z_s = Z$$

$$R_p * R_s = |Z^2|$$

$$\tan \delta_{serial} = \tan \delta_{parallel} = \frac{1}{\omega * R_p * C_p} = \omega * R_s * C_s$$

where:

Cs serial Capacitance [F]

Cp parallel Capacitance [F]

Rs serial Resistance [ $\Omega$ ]

Rp parallel Resistance [ $\Omega$ ]

Z Impedance [ $\Omega$ ]

Zs serial Impedance [ $\Omega$ ]

Zp parallel Impedance [ $\Omega$ ]

Xs serial reactance [ $\Omega$ ]

Xp parallel reactance [ $\Omega$ ]

$\omega$  angular frequency [ $s^{-1}$ ]  $\omega = 2 * \pi * f$

$$X_s = \frac{R_p^2 * X_p}{R_p^2 + X_p^2}$$

$$X_s = \frac{R_p^2 * \omega * C_p}{1 - R_p^2 * \omega^2 * C_p^2}$$

$$X_p = \sqrt{\frac{R_p^2 * R_s}{R_p - R_s}}$$

where:

Cs serial Capacitance [F]  
Cp parallel Capacitance [F]  
Rs serial Resistance [ $\Omega$ ]  
Rp parallel Resistance [ $\Omega$ ]

$\omega$  angular frequency [ $s^{-1}$ ]  $\omega = 2 * \pi * f$   
Xs serial reactance [ $\Omega$ ]  
Xp parallel reactance [ $\Omega$ ]

### 6.2.3.1 Simplifications for small Dissipation / Power Factor

If the dissipation / power factor is small, the error can be neglected and you can use the following simplifications:

$$C_s \approx C_p$$

$$Z \approx X_s \approx X_p$$

$$R_s \approx X_s * \tan \delta$$

$$R_p \approx \frac{X_p}{\tan \delta}$$

$$Error \approx 1 + \tan^2 \delta$$

For  $\tan \delta < 3\%$ , the difference between PF and  $\tan \delta$  is smaller than 0.1%

where:

- Cs serial Capacitance [F]
- Cp parallel Capacitance [F]
- Z Impedance [ $\Omega$ ]
- Xs serial reactance [ $\Omega$ ]
- Xp parallel reactance [ $\Omega$ ]
- Rs serial Resistance [ $\Omega$ ]
- Rp parallel Resistance [ $\Omega$ ]

## 6.2.4 Conversion capacitances to inductances<sup>1</sup>

The CAPO is able to measure the inductance. With the formulas below you can make the conversion.

If the CAPO detect an inductance instead of a capacitance,  $C_{xp}$  will switch to  $L_x$  (the  $\tan \delta$  /PF will switch to Quality factor<sup>2</sup>).

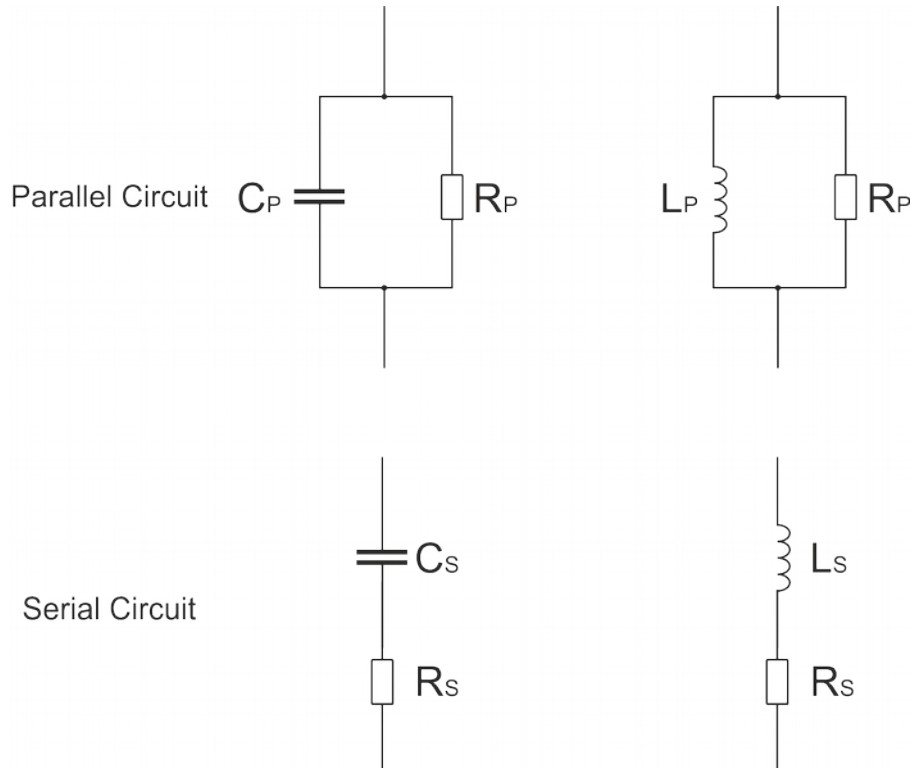

$$Z = \frac{1}{j\omega C_s} + R_s = j\omega L_s + R_s$$

$$R_s = R_s$$

$$\frac{1}{j\omega C_s} = j\omega L_s \Rightarrow 1 = -\omega^2 L_s C_s$$

$$L = \frac{-1}{\omega^2 * C}$$

$$Q = \frac{1}{\tan \delta_C}$$

where:

L Inductances [H]

$\omega$  angular frequency [ $s^{-1}$ ]  $\omega = 2\pi * f$

C Capacitance [F]

Q Quality factor

R Resistance

$\tan \delta_C$  Dissipation factor

<sup>1</sup> It is necessary to distinguish between serial and parallel ( $L_p$ ,  $L_s$  and  $C_p$ ,  $C_s$ )

<sup>2</sup> The quality factor (or Q) of an inductor is the ratio of its inductive reactance to its resistance at a given frequency.



## 7 Operation Elements

### 7.1 CAPO 2.5

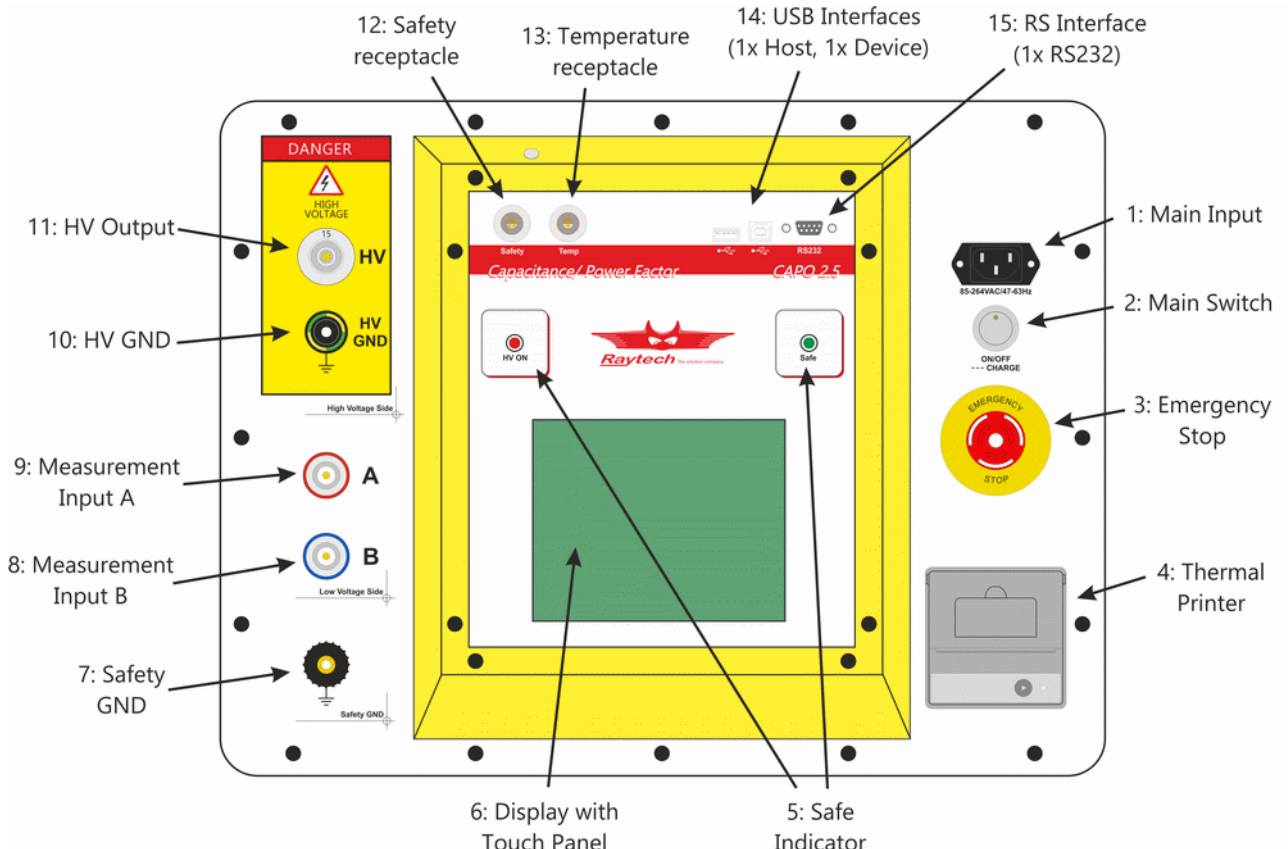

#### 1: Main Input

Connect the power cable to the Main Input.

Press the Main Switch to switch the CAPO on / off.

#### 2: Main Switch

Press to power the CAPO on / off.

#### 3: Emergency Stop

Press to stop: The measurement will stop and immediately switch off the high voltage.

Turn clockwise to release. The device will remain in a safe mode state.

#### 4: Thermal Printer

Allows you to quickly get your results on paper by using the built-in thermal printer.

#### 5: Safety Indicator

Green Light on: System is in safe mode. Ready for handling test leads, connections.

Red Light on: Unsafe mode! Don't remove any cables and don't touch the test object.



#### **WARNING !**

High voltage is on!

#### 6: Display with Touch Panel

The instrument can be easily manipulated and fully controlled by the touch screen panel. If preferred, an external mouse or keyboard can be connected to the USB Port to control the system.

#### 7: Safety GND

Connect a proper earth.

The FIRST cable you have to connect and lead to earth ground is always the Safety GND. This is also the LAST cable to disconnect! Any interruption of the grounding connection can create an electric shock hazard.

#### 8: Measurement Input B

Connect the red measurement cable to this input.

#### 9: Measurement Input A

Connect the blue measurement cable to this input.

#### 10: HV GND

This is also a measurement Input. Connect the green-yellow cable to this input.

#### 11: HV Output<sup>1</sup>

This is the receptacle for the high voltage. Connect the orange high voltage cable to this input.

<sup>1</sup> This is not the same plug as the one from the CAPO 12, the cables are not interchangeable!

### **12: Safety receptacle**

Here you can connect the Safety-Switch.

For more detail about this receptacle have a look in the chapter 11.1.3 Safety on page 94.

### **13: Temperature receptacle**

This receptacle is for an external temperature probe.

(Optional Accessory TP01)

### **14: USB Interface**

1 x USB Host

1 x USB Device

See chapter 11.1.2 USB on page 93 for details.

### **15: RS Interface**

RS232

See chapter 11.1.1 RS 323 on page 93 for details.

## **7.2 CAPO 12**

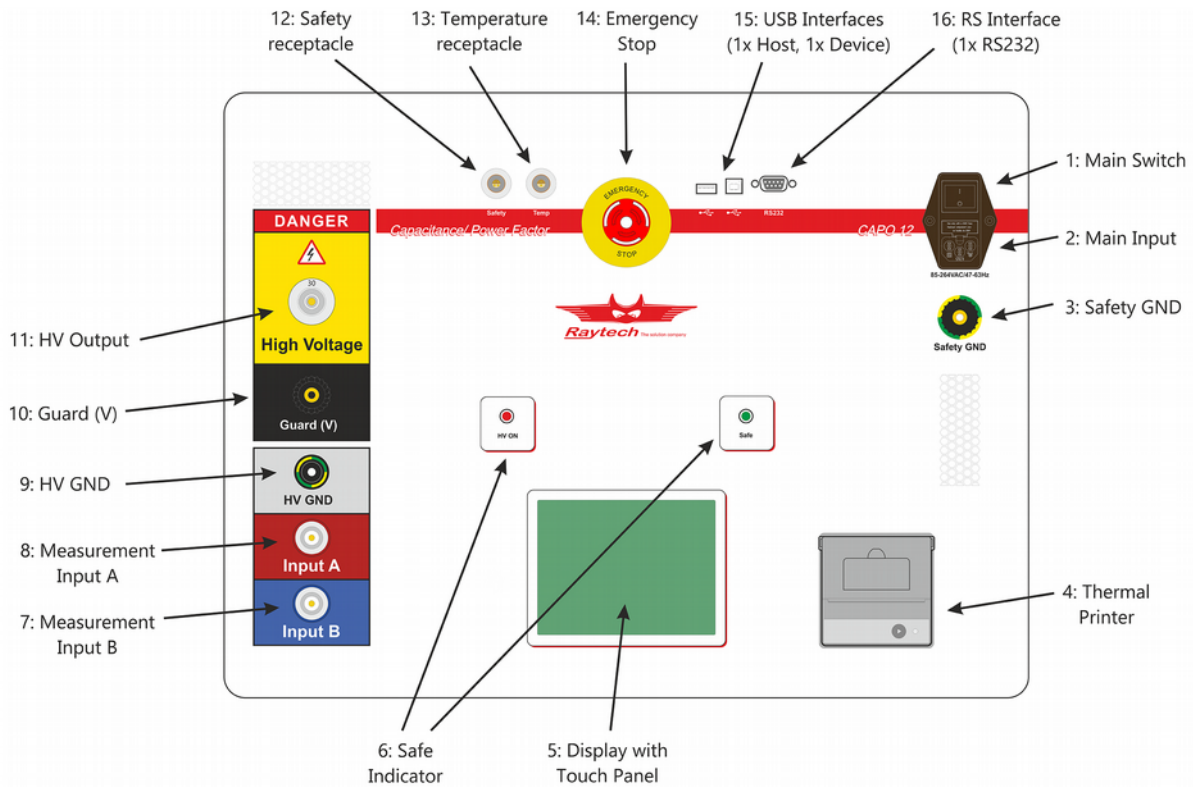

### 1: Main Switch

Press to power the CAPO on / off.

### 2: Main Input

Connect the power cable to the Main Input.

Press the Main Switch to switch the CAPO on / off.

A slow acting Fuse (T 10A) protects the device. (Use only the correct fuse type to replace it).

### 3: Safety GND

Connect a proper earth.

The FIRST cable you have to connect and lead to earth ground is always the Safety GND. This is also the LAST cable to disconnect! Any interruption of the grounding connection can create an electric shock hazard.

#### 4: Thermal Printer

Allows you to quickly get your results on paper by using the built-in thermal printer.

### 5: Display with Touch Panel

The instrument can be easily manipulated and fully controlled by the touch screen panel. If preferred, an external mouse or keyboard can be connected to the USB Port to control the system.

### 6: Safe Indicator

Green Light on: System is in safe mode. Ready for handling test leads, connections.

Red Light on: Unsafe mode! Don't remove any cables and don't touch the test object.



**WARNING !**  
High voltage is on!

### 7: Measurement Input B

Connect the **redblue** measurement cable to this input.

### 8: Measurement Input A

Connect the **bluered** measurement cable to this input.

### 9: HV GND

This is also a measurement Input. Connect the green-yellow cable to this input.

### 10: Guard (V)

Everything connected to this potential is not taken into account for the measurement. It is the same potential as the shield of the measurement cables.

### 11: HV Output<sup>1</sup>

This is the receptacle for the high voltage. Connect the orange high voltage cable to this input.

### 12: Safety receptacle

Here you can connect the Safety-Switch.

For more detail about this receptacle have a look in the chapter 11.1.3 Safety on page 94.

<sup>1</sup> This is not the same plug as the one from the CAPO 2.5, the cables are not interchangeable

### **13: Temperature receptacle**

This receptacle is for an external temperature probe.

(Optional Accessory TP01)

### **14: Emergency Stop**

Press to stop: The measurement will stop and immediately switch off the high voltage.

Turn clockwise to release. The device will remain in a safe mode state.

### **14: USB Interface**

1 x USB Host

1 x USB Device

See chapter 11.1.2 USB on page 93 for details.

### **15: RS Interface**

RS232

See chapter 11.1.1 RS 323 on page 93 for details.

## 8 Operating Menu

The instrument software is straight forward and easy to set up and operate. With a few key strokes and selections on the test screen, measurements can be started. See chapter Fehler: Verweis nicht gefunden Fehler: Verweis nicht gefunden on page Fehler: Verweis nicht gefunden.

### 8.1 Menu Structure

CAPO 12 menu is structured as shown in the figure below.

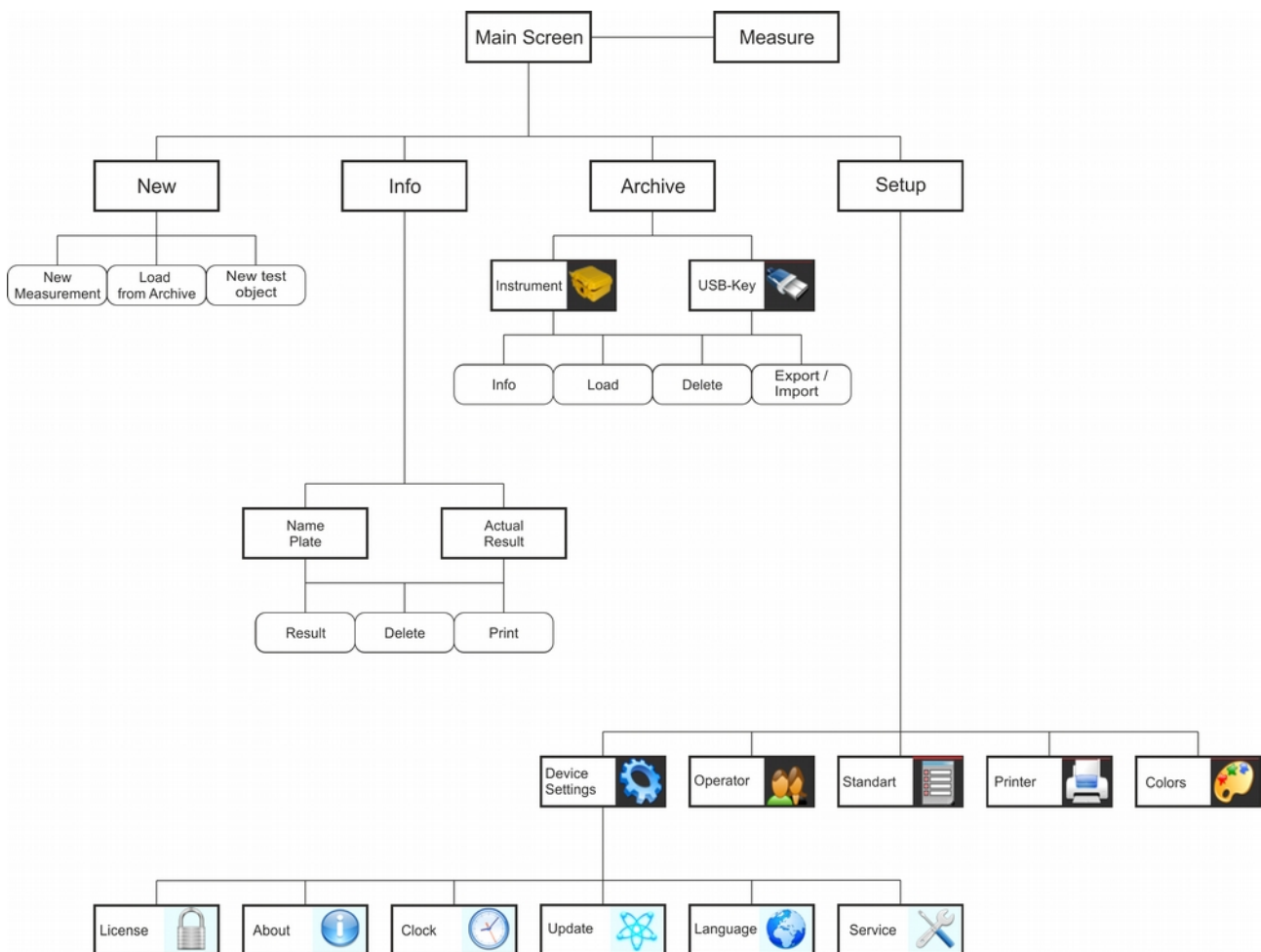



## 8.2 Main Menu

### 8.2.1 Main Menu Screen

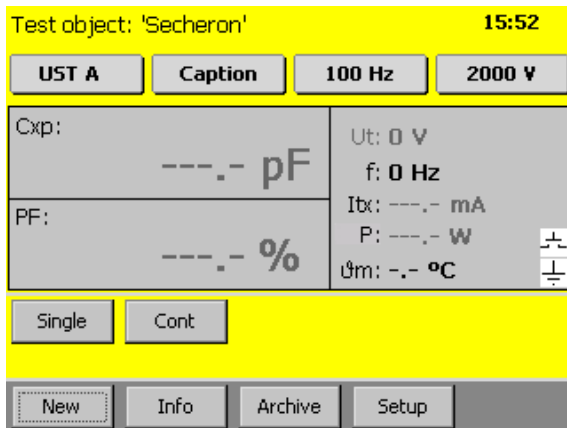

The Touch screen enables quick navigation by tapping directly on the screen. e.g. if you would like to change the measurement voltage, tap on it and the Menu “Select Test Voltage” will open.

#### UST A

Select the measurement Mode.

For more information see chapter 9 Measurement Modes on the page 72.

#### Caption

User defined Caption for the measurement result.

#### 100 Hz

Select the measurement test frequency.

#### 2000 V

Select the measurement voltage.

#### Cxp:

Shows the measurement result. You can tap on it to change from capacitance [Farad] to Inductance [Henry].

#### PF / $\tan\delta$ :<sup>1</sup>

Shows the measurement result. You can tap on it to change from PF (Power Factor) [%]. /  $\tan\delta$  to Rp (Serial Resistance).

If you have selected inductance in the upper field, you will see here Q (Quality Factor).

<sup>1</sup> If you measure Inductance, you will see here the quality Q

<sup>2</sup> Depending on your default settings in the Setup

**Ut:**

Measurement test voltage [V].

**f:**

Measurement frequency [Hz].

**I<sub>tx</sub>:**

Measurement current [A] through test object (depending on measurement mode). This is the total current through the test object.

If you tap on it, it will change to **I<sub>r</sub>**, **I<sub>c</sub>**, **I<sub>x10k</sub>**.

**I<sub>r</sub>**: Resistive current (in phase with an ideal resistor)

**I<sub>c</sub>**: Capacitive current (in phase with an ideal capacitor)

**I<sub>x10k</sub>**: Calculated total current you would have, when you have 10kV over this test object.

**P:**

Power [W] over test object.

If you tap on it, it will change to **P<sub>10k</sub>**: Then it shows the Power [W] @ 10kV. This is the calculated power you would have, when you have 10kV over this test object.

**∅m:**

If you connect a temperature probe (TP01), you will see the measured temperature.

If the receptacle "Temp" is open, you can click on ∅m: and enter the temperature manually.

**Single / Multi<sup>1</sup>**

Single: Starts a single measurement.

Multi: Starts measurements with multiple parameters

**Cont**

Starts a continuous measurement.

**Print**

Prints the measured result.

**Save**

Saves the measured results.

**New**

Opens the menu for a new transformer template or a new measurement.

<sup>1</sup> It depends on the selected Test Mode or voltage- / frequency sweep

**Info**

Opens the menu for the information about the results or the actual transformer template.

**Archive**

Opens the menu with the stored results and transformer templates on the instrument and the USB-key, if you have one connected.

**Setup**

Opens the Setup menu.

### 8.2.1.1 Safety-Switch

On the right side of the main screen is a symbol for the Safety-Switch.

Safety Switch is open

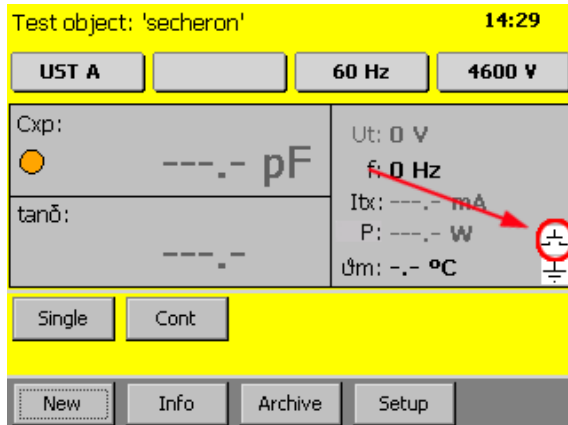

Safety Switch is pressed

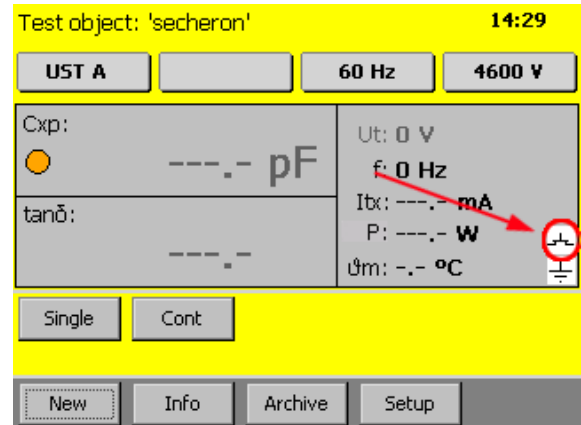

### 8.2.1.2 Earth connection

Below the symbol for the Safety-Switch there is the symbol for the earth connection.

If the symbol is crossed, the earth connection is open

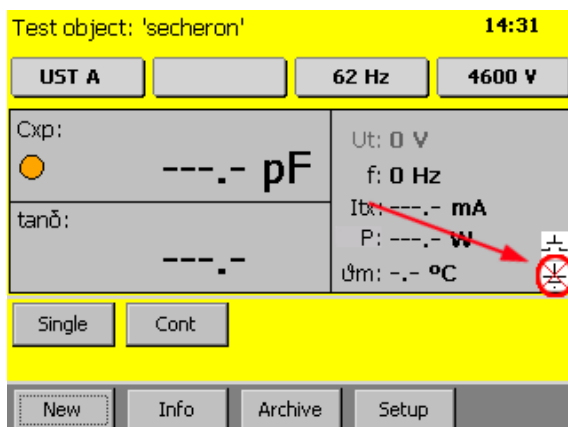

Earth connection is OK

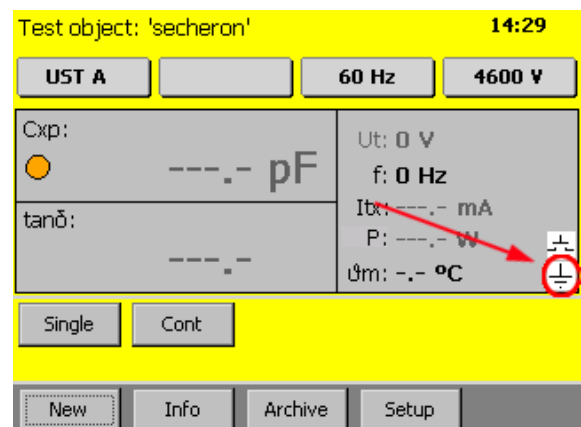

### 8.2.1.3 Test object

At the top of the screen the name of the actual profile is visible. Change it by tapping “Info” and select the tab “Name Plate”.

**Info** in the bottom of the screen

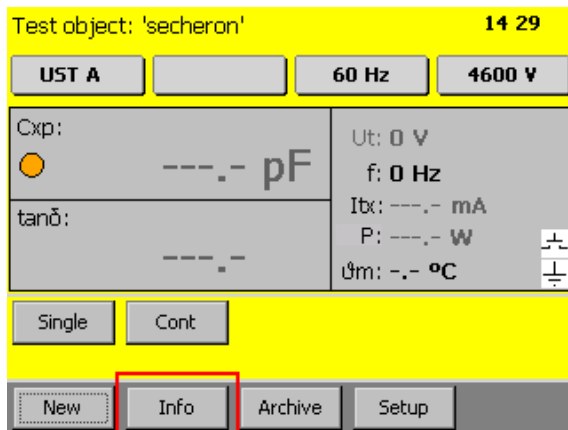

The Name Plate, with Information

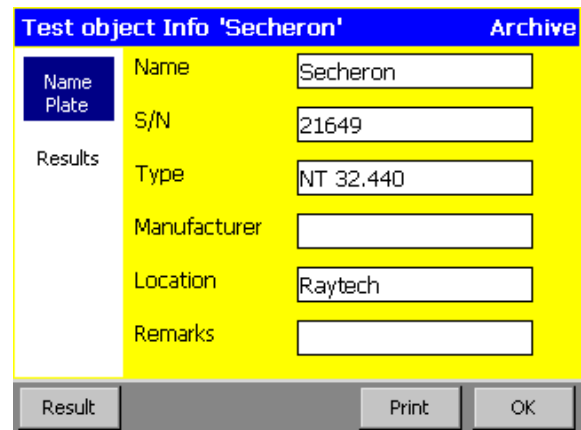

### 8.2.1.4 Time

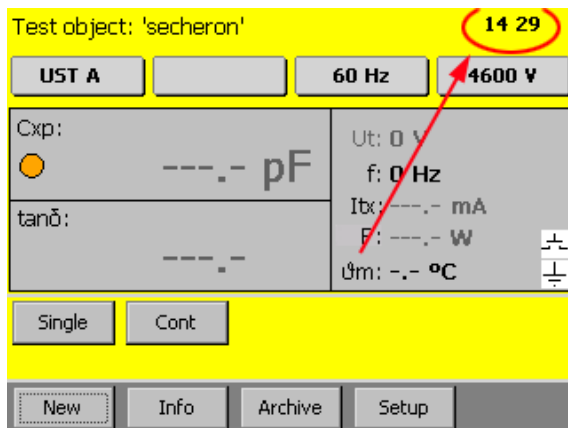

The actual Time is visible in the main screen to the upper right corner. The time and the date is adjustable in the Setup under Clock. Have a look on chapter 8.2.7.1.3 Clock on page 59.

### 8.2.1.5 Battery Symbol

The battery symbol indicates the level of the battery and if the mains are connected or not.

It is only available in the CAPO 2.5.

Mains operation and charging. A plug symbol is in the Battery

Battery operation

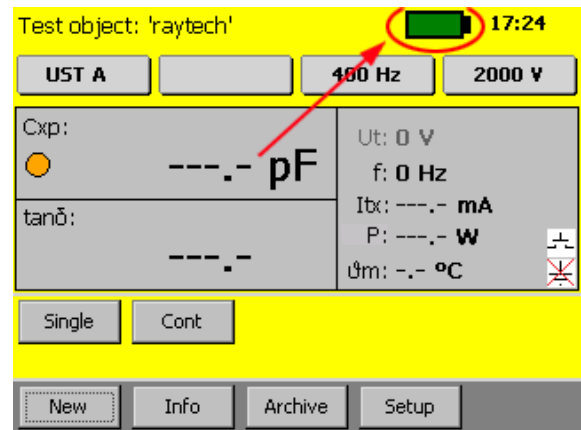
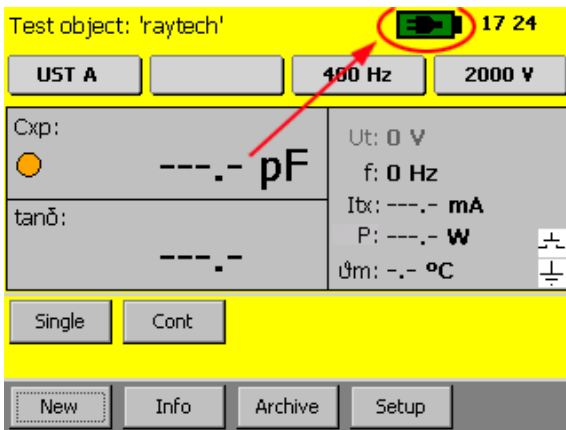

## 8.2.2 Measurement Mode

The actual measurement Mode is visible on the main screen

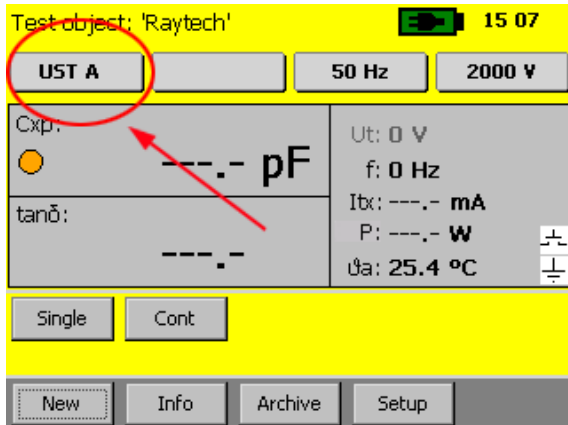

If you need to change it, tap on it and a new window will open

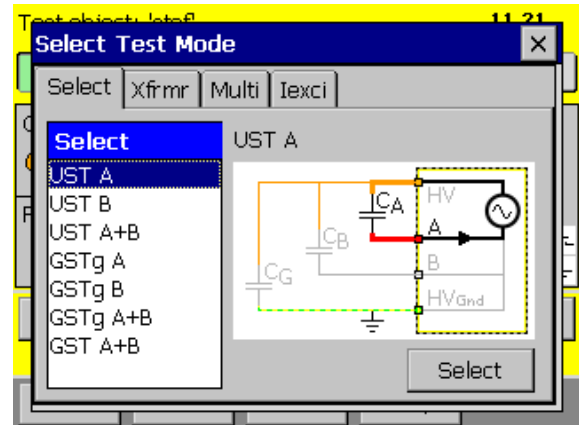

For more information about the measurement modes see chapter 9 Measurement Modes on page 72.

### 8.2.3 Caption

This is a user defined text that marks the results.

The actual text of the caption is visible on the main screen

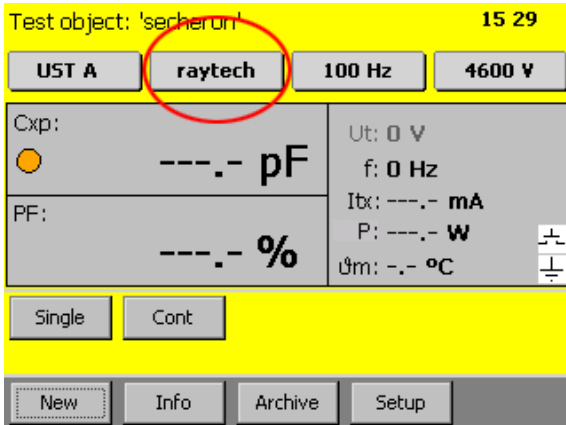

If you need to change it, tap on it and a new window will open

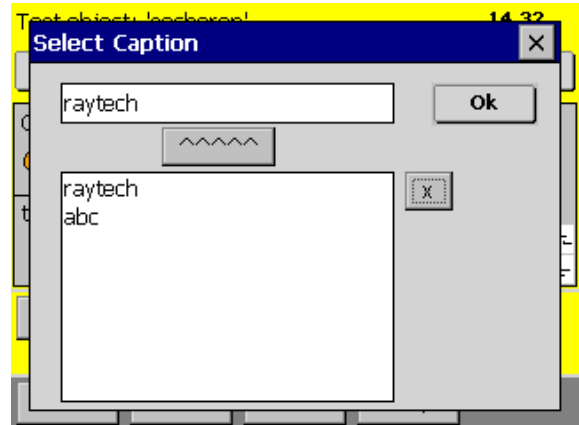

Select a text from the list and press the  button

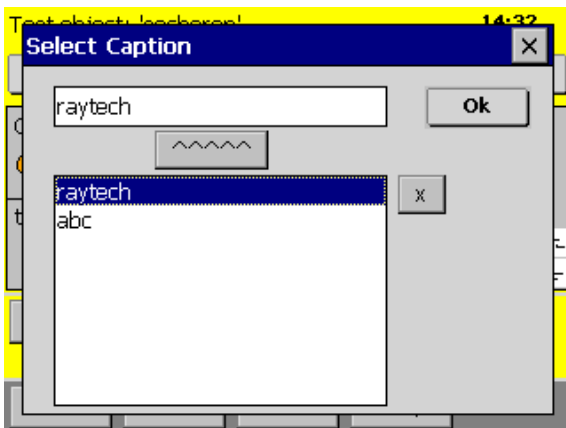

Or click on the text field to change the actual text or enter a new one





## 8.2.4 Measurement frequency

The actual measurement frequency is visible on the button

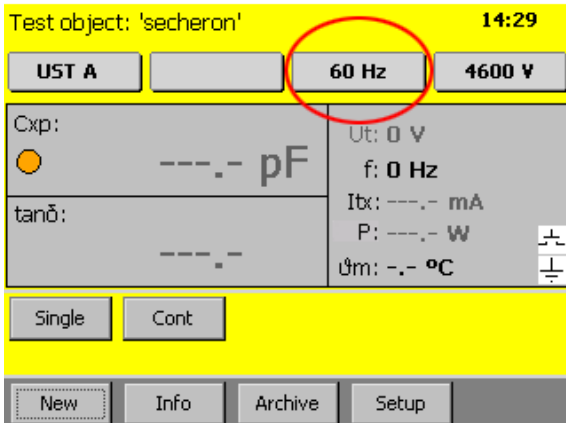

If you would like to change it, tap on it and a new window will open. This is also possible during a measurement

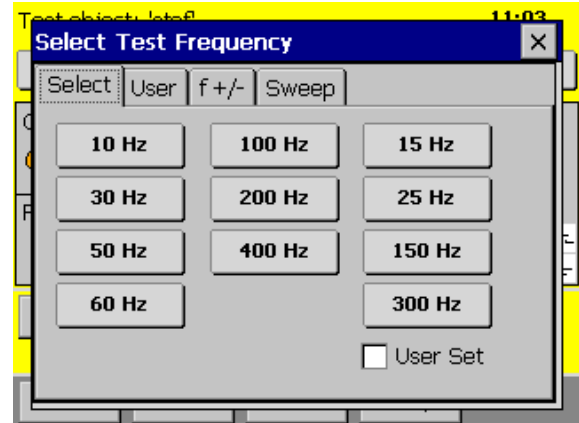

Select the frequency you want. The four buttons on the right can be set by the user, just select the "✓ User Set" and you can change them by pressing the button

On the second tab **User** you can increase or decrease the actual frequency

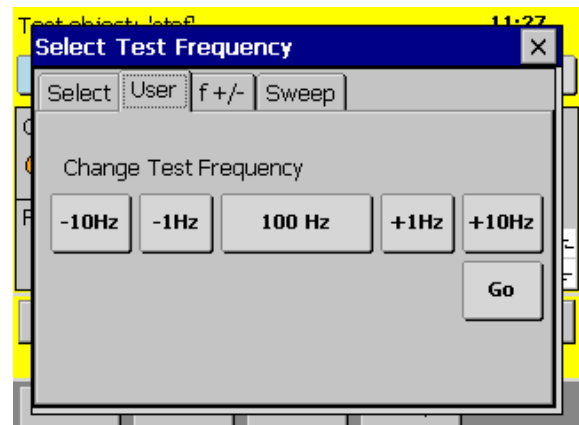
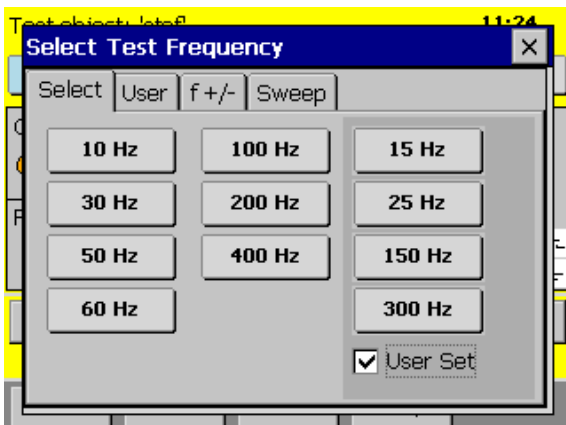

On the third tab **f +/-** you find a solution if you have heavy interference on the line frequency.

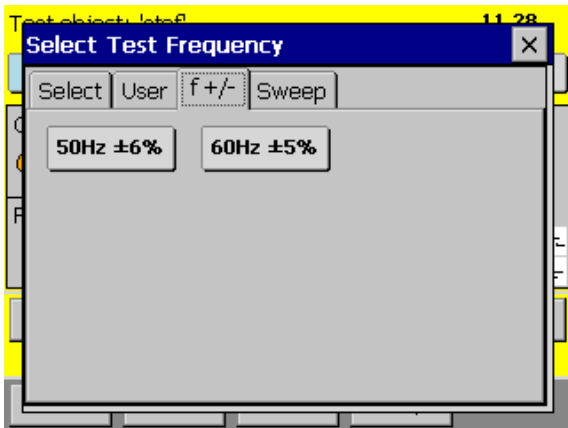

The CAPO performs measurements at vicinity of the selected frequency. By this method noises and disturbances on line can not decrease the accuracy of measurement. However CAPO will calculate the result based on the selected frequency.

Please note that continuous measurement is not possible in this method.

Under the Tab **Sweep** it would be possible to store different lists of frequencies. The CAPO will start with the first frequency of the selected list. After a proper measurement result, it will automatically change to the next frequency and perform the measurement.

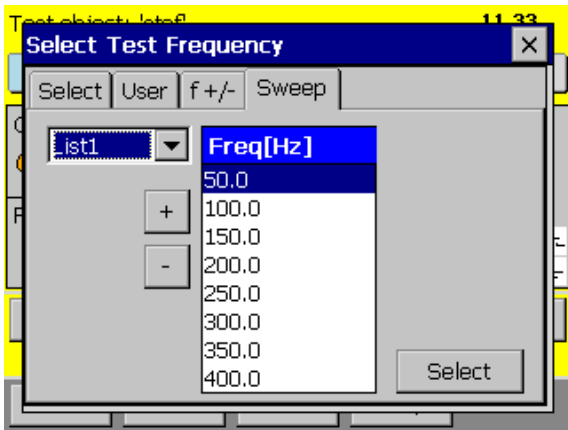

Edit a list:

To Add or Remove a frequency of the list, use the button  or

## 8.2.5 Measurement voltage<sup>1</sup>

The actual selected measurement voltage is visible on the button

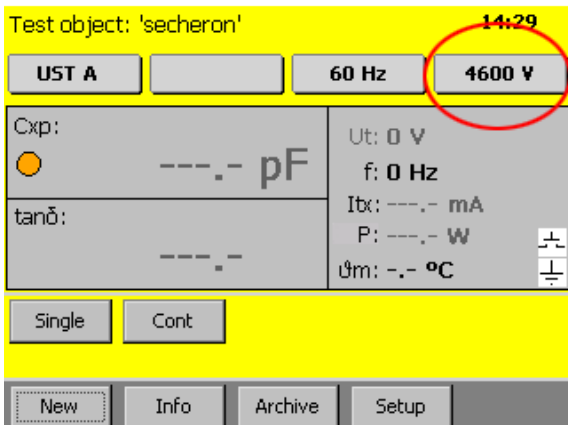

If you would like to change it, tap on it and a new window will open. This is also possible during a measurement

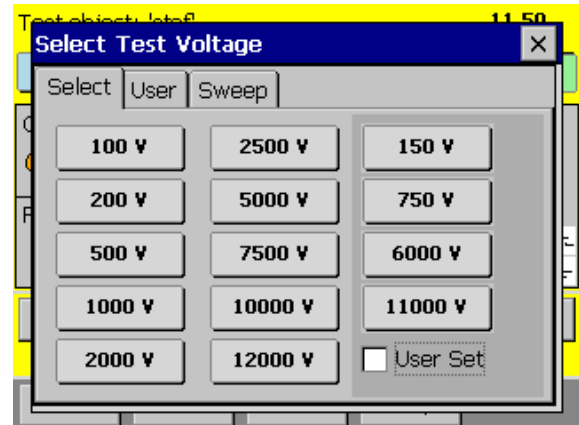

<sup>1</sup> Maximum voltage of CAPO 2.5 is 2'500V, CAPO 12 has a maximum voltage of 12'000V

Select the voltage you want. The four buttons on the right, can be set by the user, just select the " User Set" and press on the button you want to change.

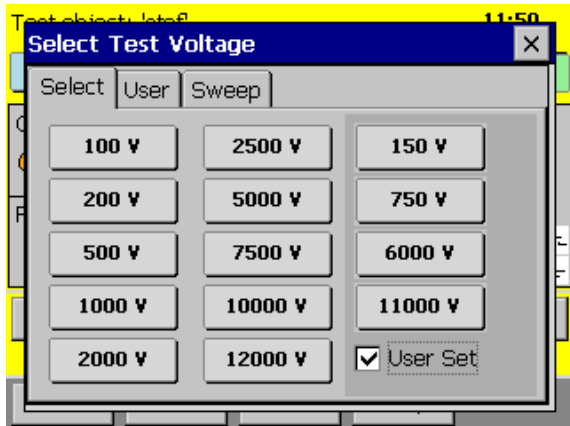

On the second tab **User** there is the option to increase or decrease the actual voltage.

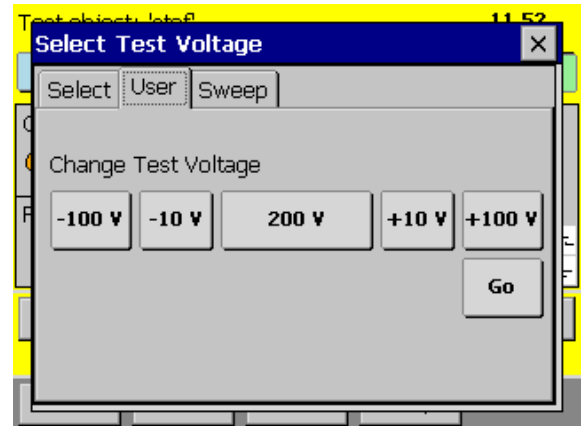

Under the tab **Sweep** it would be possible to store different lists of voltages. The CAPO will start with the first voltage of the selected list. After a proper result, it will automatically change to the next voltage and perform the measurement.

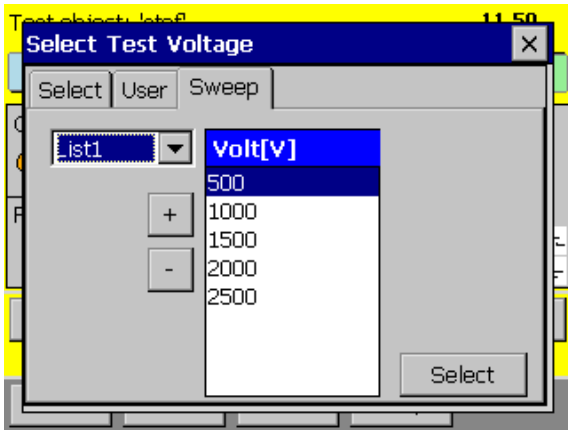

Edit a list:

To Add or Remove a voltage of the list, use the button **+** or **-**

## 8.2.6 Start a measurement



### **WARNING !**

Hazardous voltage may result in severe injury or death!

Before performing any test with this instrument, read this user manual and observe all safety precautions indicated.



### **NOTE:**

The **FIRST** cable you have to connect and lead to earth ground, is always the Safety GND

There are different measurement modes: Single, Continuous, Multi.

### 8.2.6.1 Single measurement

To start a single measurement, press and hold the Safety Switch and afterwards press the **Single** button

The CAPO will do the measurement and after you get a stable result, it will automatically stop the measurement. You can **Save** the result or directly **Print** it on paper

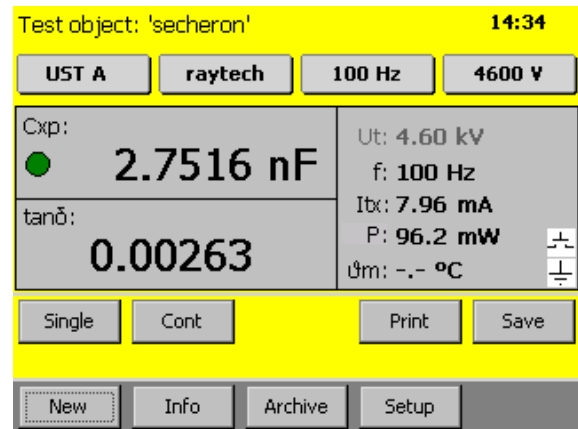
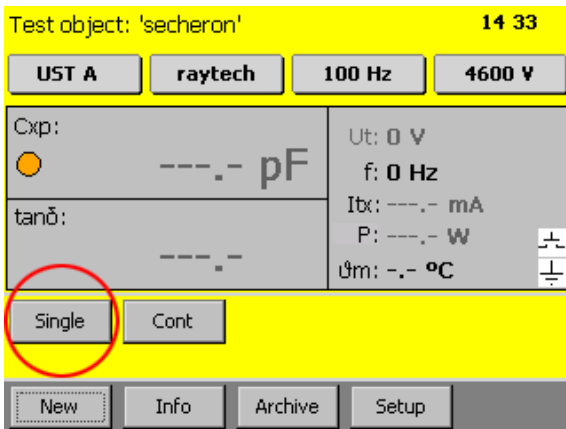

### 8.2.6.2 Multi measurement

Instead of Single the button can be labeled with **Multi**. This are multiple Single measurements.

Multi is visible if frequency- or voltage- "Sweep" is selected or the measurement Mode "Xfrmr" or "Multi".

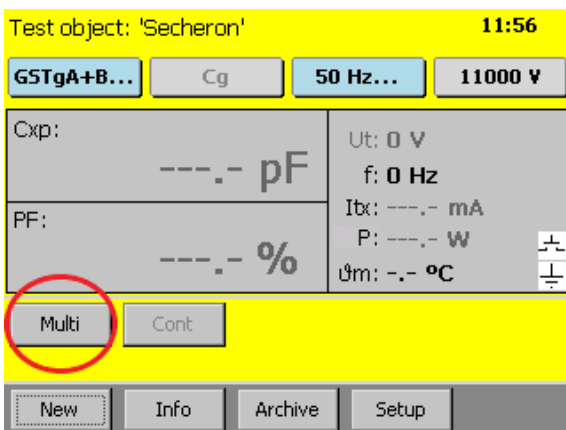

There is more information in the following chapter:

8.2.4 Measurement frequency on page 49

8.2.5 Measurement voltage on page 51

9.5 Xfrmr on page 81

9.6 Multi on page 84

### 8.2.6.3 Continuous measurement

To start a continuous measurement press and hold the Safety Switch and afterwards press the button **Cont**

During the measurement you can change the measurement channel (e.g. from **UST A** to **GSTg B**). You also don't have to stop the measurement if you want to change the frequency or the voltage.

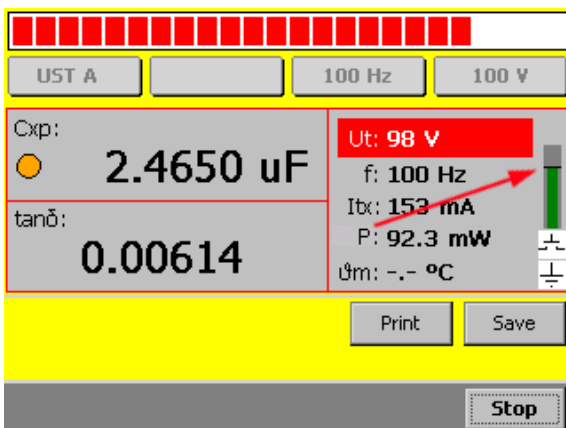
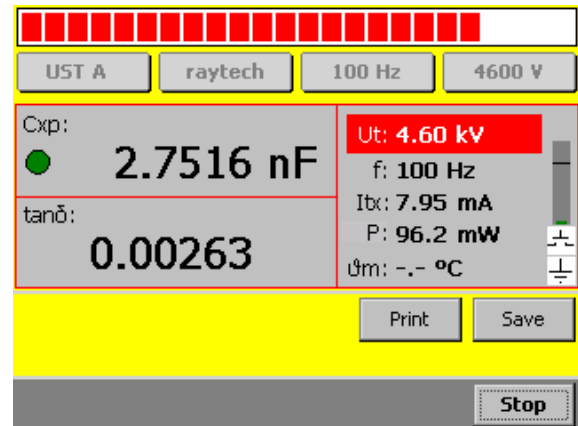
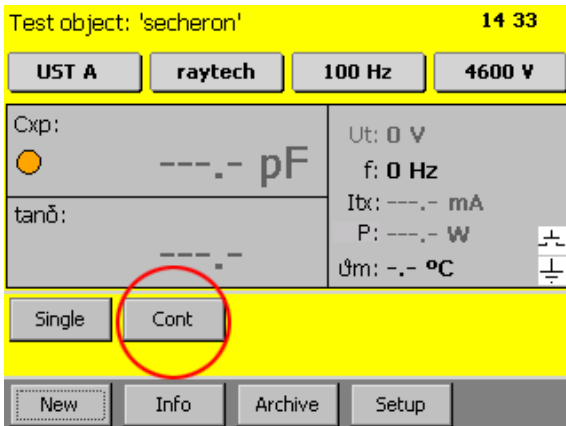

During all measurement there is a bar on the right side of the screen. It indicates the total current which is actually flowing. The black line means 150mA

During or after the measurement you can tap the dissipation factor measurement to switch between tangent delta ( $\tan \delta$ ) / Power Factor (PF)<sup>1</sup> and Rp (parallel Resistance)

Small values of  $\tan \delta$  or PF, will have the same numbers.

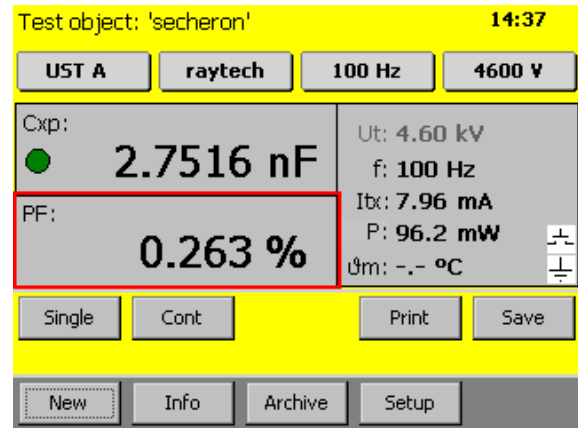
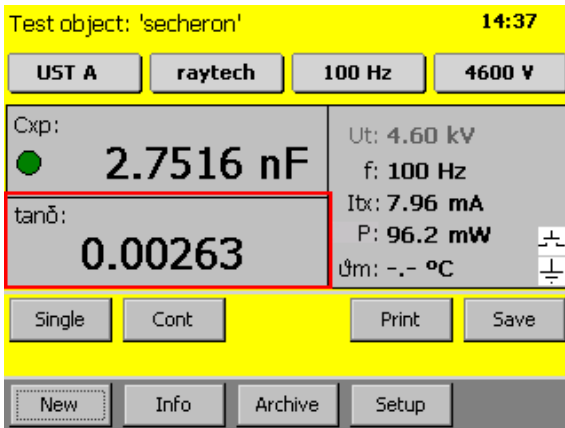

### Inductive loads:

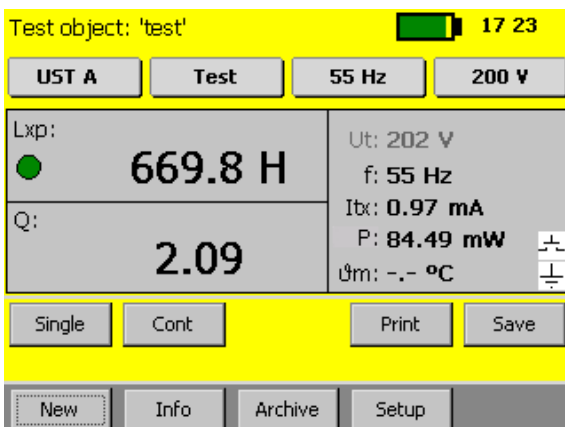

If the test object is inductive, the instrument shows automatically Lxp instead of Cxp and instead of the dissipation factor ( $\tan \delta$  / PF) it shows the quality factor Q.

The quality factor Q of an inductor is the ratio of its inductive reactance to its resistance at a given frequency.

1 Depending on your default setting in the Setup



## 8.2.7 Setup

By pressing the Setup button, the Setup screen will appear.

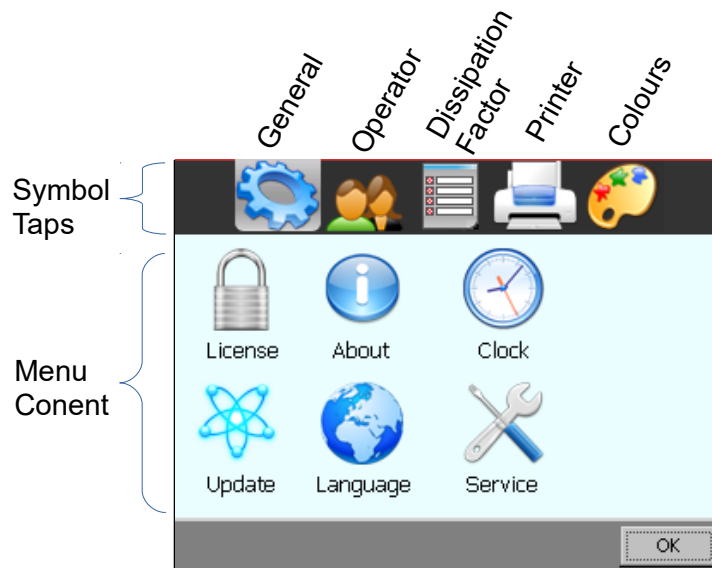

The setup menu contains the following five<sup>1</sup> parts:

- General
- Operators
- Dissipation Factor
- Printer
- Colour

They can easily be switched with the symbol taps on top of the screen.

The content of this five parts is described in the following chapters.

<sup>1</sup> With the Service-Code "1200#" it is possible to add a sixth part. Have a look in the attachment "F.6 Oil Correction Table" on page 107.

### 8.2.7.1 General

The General tap contains the 6 following parts:



#### 8.2.7.1.1 License

License Manger is used to enter a Raytech license number. If your license state changes, you may be asked to enter a new license.

This menu displays the actual license state. By touching the **Enter new License Key** button you can do so

To modify or extend the license, enter a new license code.

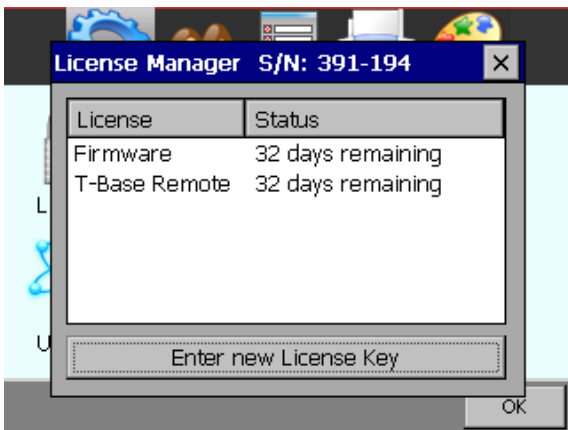

**NOTE:**

The license code is generated by Raytech AG

### 8.2.7.1.2 About



Choose this menu to get information about the instrument like firmware version and serial number.

### 8.2.7.1.3 Clock

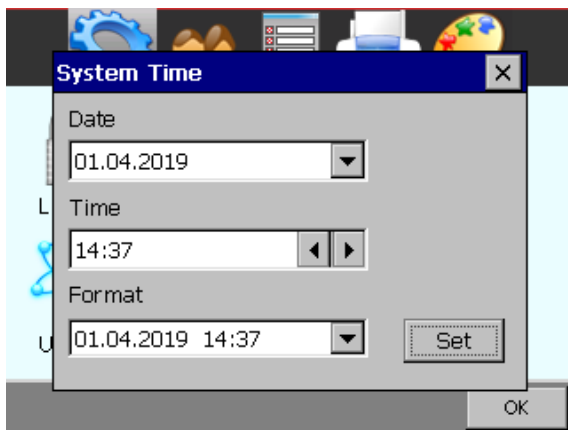

Use this menu, to set date and time. This is important for your data sets, because your measurement will contain a time stamp.

### 8.2.7.1.4 Cursor

Lower versions than 0.8.8 of the Firmware had an option to activate a cursor of a USB mouse.

This option is no longer needed in newer firmware. It will automatically recognize it if you connect a USB-Mouse or a Track ball and a mouse cursor will be visible during the motion of the mouse. The instrument can then be fully controlled by the mouse.

### 8.2.7.1.5 Update

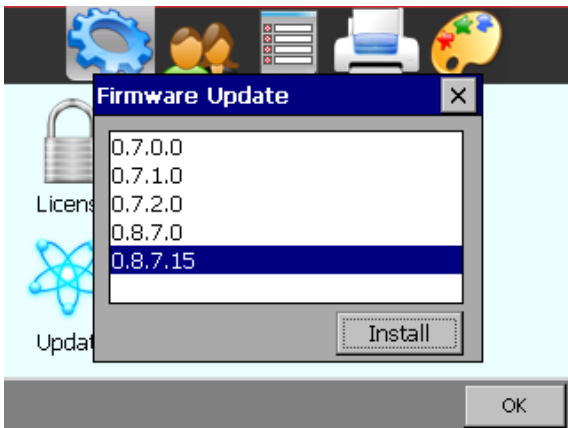

New Firmware versions are available free of charge at [www.raytech.ch](http://www.raytech.ch)

Download the new Firmware (.zip file) onto your USB key on the root directory (Not in a sub-directory and do not Unzip it).

Connect the USB key to the instrument and press **Install**. The system will detect and automatically install the new firmware and restart the system.

### 8.2.7.1.6 Language

The CAPO firmware supports different languages. Use this menu, to choose your favourite language from a list of available languages.

Restart the instrument to activate the desired language selected.

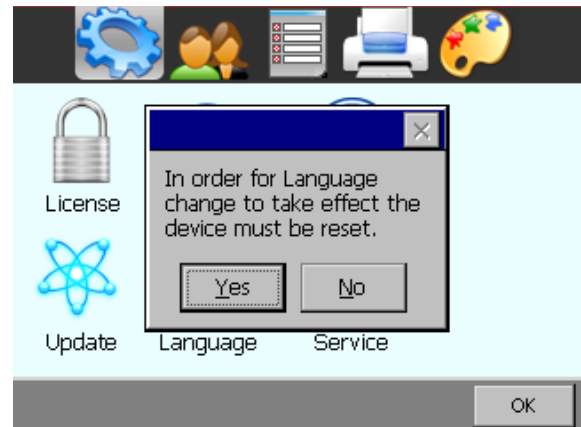
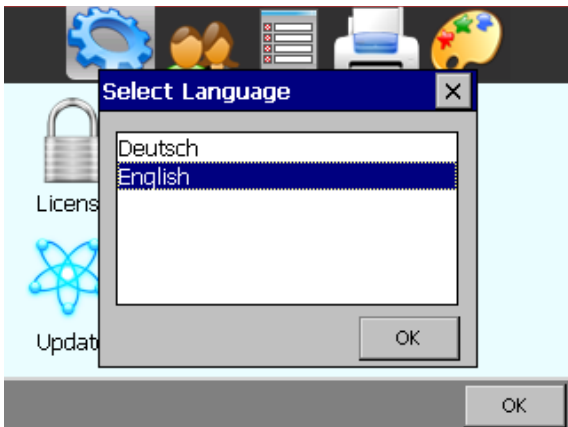

### 8.2.7.1.7 Service

There are several embedded codes to allow different settings, e.g. calibrate the touchscreen, activate USB-driver and so on. For more information see chapter F Service Mode on page 104.

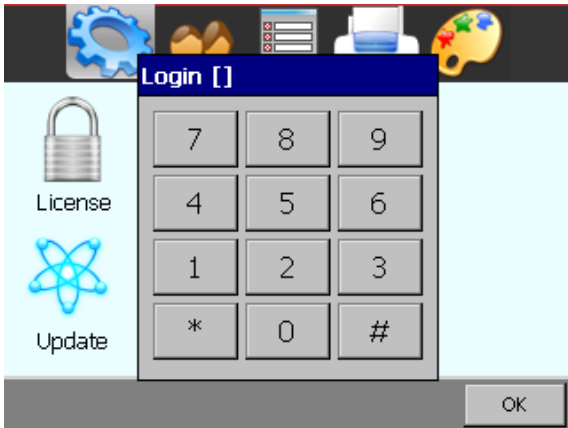

The Service Mode has a limited access.

Enter the corresponding code or exit directly by tapping '#'

### 8.2.7.2 Operator

Every measurement can be stored with the name of the actual operator. In this menu, new operators can enter their first and last name. Existing entries can be changed.



Touch an operators name and then touch **OK** to make your choice.

Note the " Ask for Operator at Power-up", when checked, you will be asked if the chosen operators name is yours during the start up of the instrument. This may be helpful, when several operators are using the same CAPO.

### 8.2.7.3 Oil Correction Table<sup>1</sup>



**NOTE:**

To access this feature, you must enter the service code "1200#" first

After you enter the Service Code #1200 a new symbol in the upper menu will appear.

It is possible to make a measurement correction of the PF or  $\tan \delta$  on the basis of the temperature.

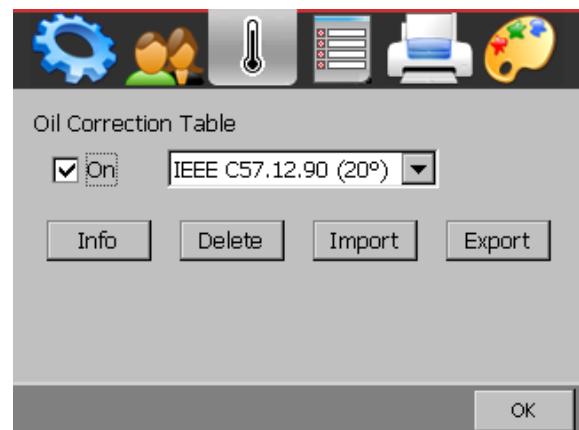
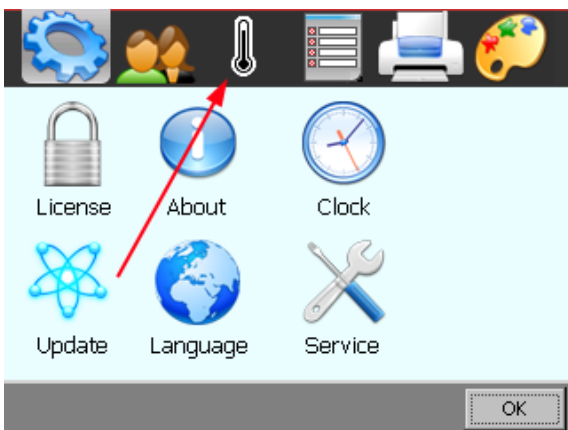

Normally this feature is disabled. But if you need it, read chapter F.6 "Oil Correction Table" in the appendix on page 107.

To enter a Service-Code, check chapter F in the appendix "Service Mode" on page 104.

<sup>1</sup> This is only available if you entered the Service Code "1200#"

### 8.2.7.4 Dissipation factor

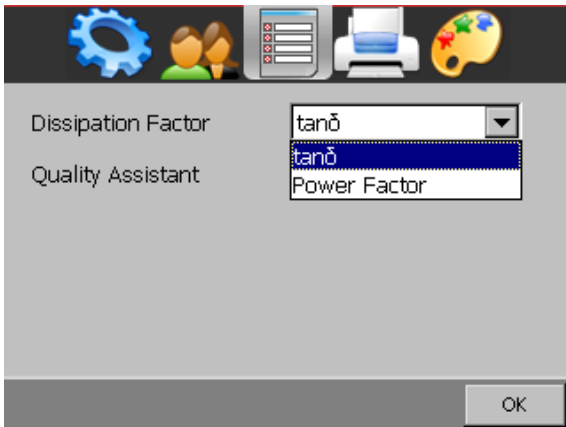

Here you can choose between the dissipation factor  $\tan \delta$  or the Power Factor  $\cos \varphi$

The one you selected, will be on the print out and on the measurement display.

### 8.2.7.5 Quality Assistant

If the Quality Assistant is enabled, a light in the main screen indicates the quality of the test result.

If the light is green, the measured result is stable

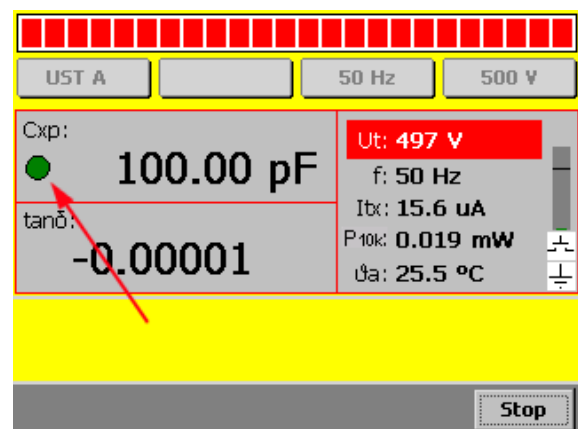
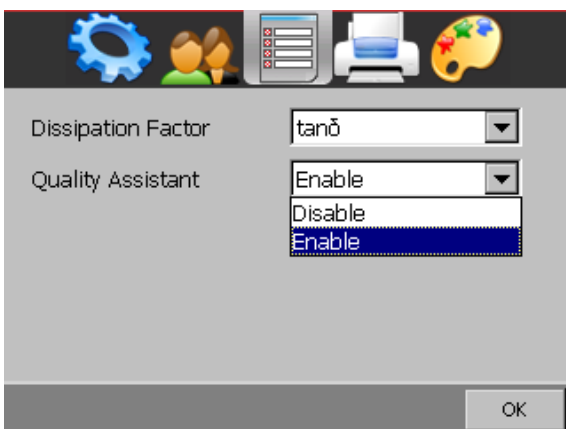

### 8.2.7.6 Printer

If you are able to use an external USB Printer, you should choose the correct emulation.



Connect your USB Printer to the CAPO's USB host connector. Touch the USB Printer symbol and select the emulation of your USB Printer.

Maybe you would like to print a test page, to make sure everything works properly.

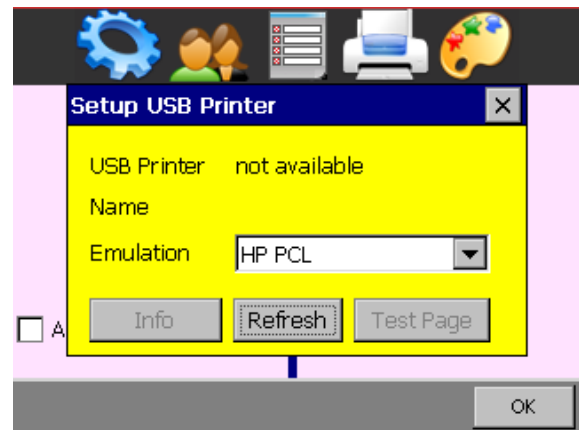
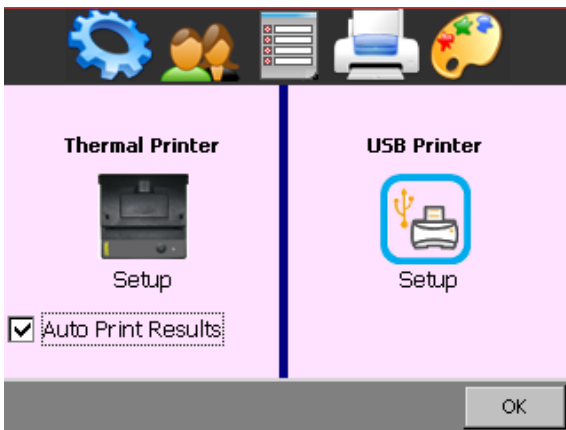

For more Information see Appendix E USB Printer Info on page 103.

**Auto Print Results:** If you select it, the CAPO will automatically print the result after a finished Single measurement.

### 8.2.7.7 Colour

Two recommended colour schemes are available.

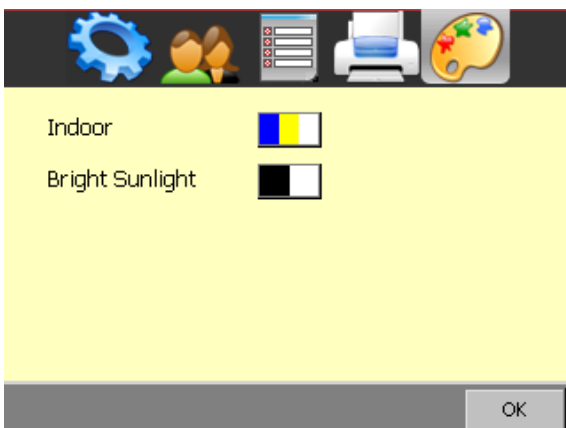
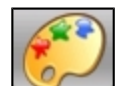

Indoor and in moderate sunlight you may prefer the coloured scheme.

In bright sunlight "black and white" provides maximal contrast, to make sure everything remains readable.



### 8.3 Results and data structure

The measurement results can be stored on the internal memory or on an external USB-key. It's possible to exchange the results from the internal memory to external USB-keys or direct to a computer.

Create a "test object" for an easy organization of all measurement results. Under a "test object" it is possible to store multiple measurements.

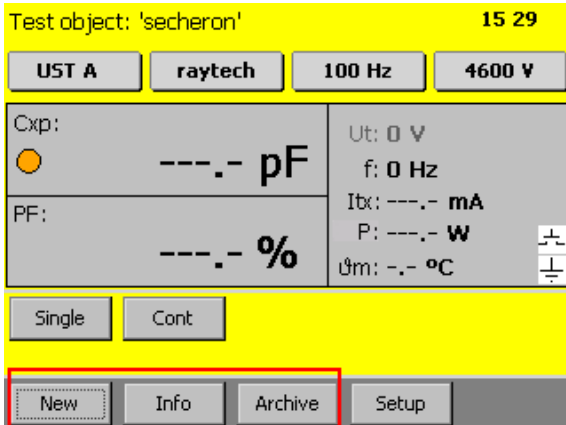

To work with the test object and organize the results, there are three buttons on the main screen

#### 8.3.1 New

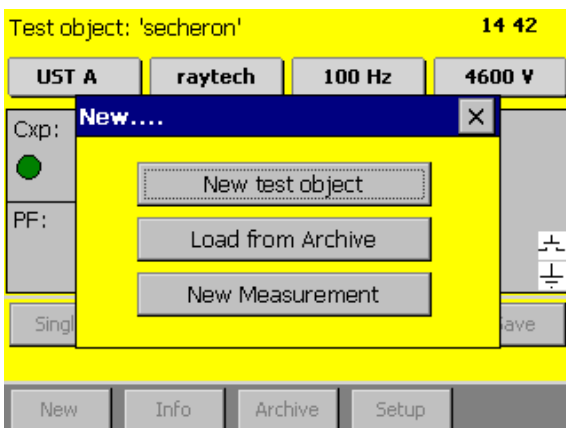

A new window will open after pressing the button **New**

### 8.3.1.1 New test object

Creating a new test object

After clicking on **New test object** the following screen is visible:

Just tap on the input window you would like to change and a new window will open with a keyboard<sup>1</sup>

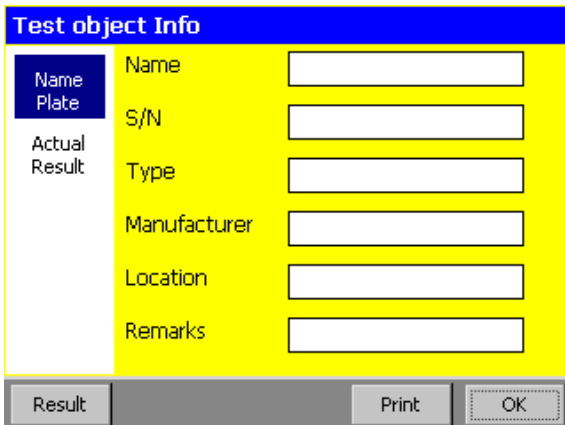

**Test object Info**

Name	Name	<input type="text"/>
Plate	S/N	<input type="text"/>
Actual Result	Type	<input type="text"/>
	Manufacturer	<input type="text"/>
	Location	<input type="text"/>
	Remarks	<input type="text"/>

Buttons: Result, Print, OK



**Test object Info**

Name

Plate

Actual Result

Keyboard overlay:

q	w	e	r	t	y	u	i	o	p
a	s	d	f	g	h	j	k	l	
↑	z	x	c	v	b	n	m	←	
123#								↩	

Buttons: Result, Print, OK

### 8.3.1.2 Load from Archive

If the test object was created and stored to memory from an earlier measurement, select **Load from Archive**.

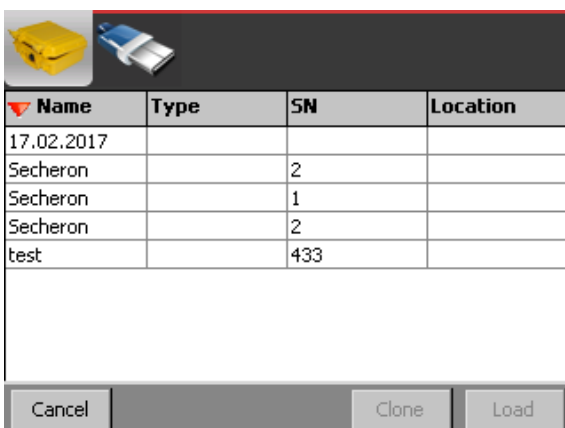

Name	Type	SN	Location
17.02.2017			
Secheron		2	
Secheron		1	
Secheron		2	
test		433	

Buttons: Cancel, Clone, Load

Now you can load an existing test object from the memory on the instrument or from a USB-key, if a USB-key is connected

<sup>1</sup> It's also possible to connect an external USB-Keyboard or Mouse to control the CAPO.

### 8.3.1.3 New Measurement

This will create a new measurement in a previously loaded test object.

### 8.3.2 Info

If you press the **Info** button, you will find data to your actual test object and measurements

In the "Name Plate" tab, you get all the information to your actual test object.

Select "Results" and you see an overview about the measurements in this test object

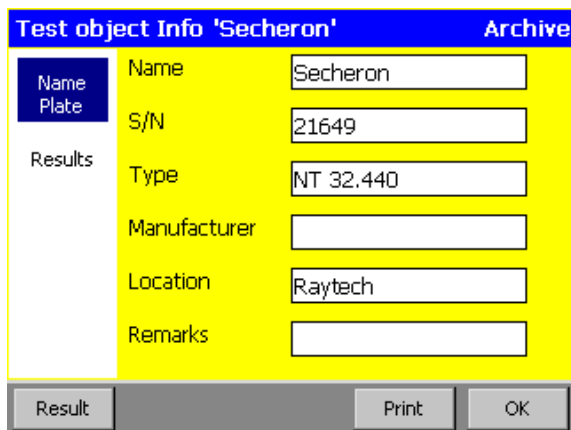

Test object Info 'Secheron'		Archive
Name Plate	Name	Secheron
	S/N	21649
Results	Type	NT 32.440
	Manufacturer	
	Location	Raytech
	Remarks	

Buttons: Result, Print, OK

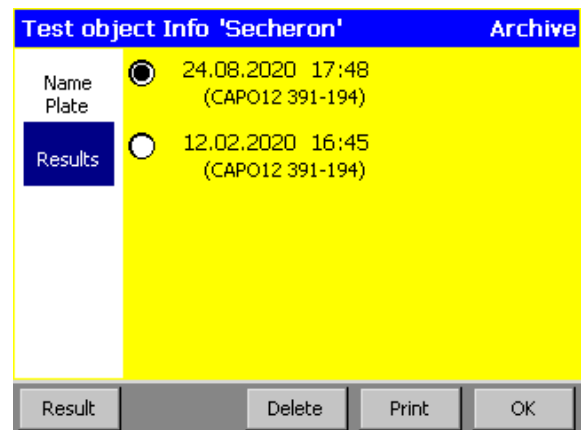

Test object Info 'Secheron'		Archive
Name Plate	<input checked="" type="radio"/>	24.08.2020 17:48 (CAPO12 391-194)
Results	<input type="radio"/>	12.02.2020 16:45 (CAPO12 391-194)

Buttons: Result, Delete, Print, OK

Use the buttons on the bottom of the display to work with the measurements. For more information have a look in the next chapter 8.3.3.1 Info on page 68.

### 8.3.3 Archive

Here you see all the test objects in the internal memory and on the connected USB-key

The actual test object is blue. If you select a different one, it is highlighted in black. It's possible to select more than one.

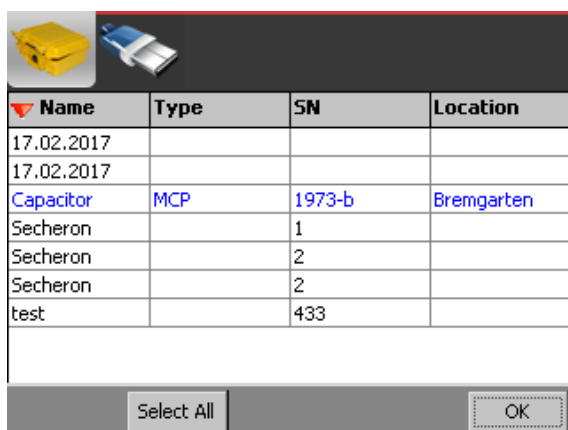

Name	Type	SN	Location
17.02.2017			
17.02.2017			
Capacitor	MCP	1973-b	Bremgarten
Secheron		1	
Secheron		2	
Secheron		2	
test		433	

Buttons: Select All, OK

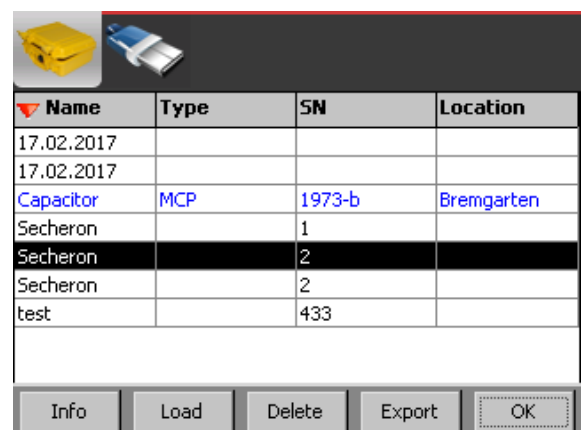

Name	Type	SN	Location
17.02.2017			
17.02.2017			
Capacitor	MCP	1973-b	Bremgarten
Secheron		1	
Secheron		2	
Secheron		2	
test		433	

Buttons: Info, Load, Delete, Export, OK

### 8.3.3.1 Info

Now if you select **Info**, you get the information about the test object and its measurements



Test object Info 'Secheron'		Archive
Name	Name	Secheron
Plate	S/N	21649
Results	Type	NT 32.440
	Manufacturer	
	Location	Raytech
	Remarks	

Buttons: Result, Print, OK

In the "Results" tab, you get an overview of your measurements

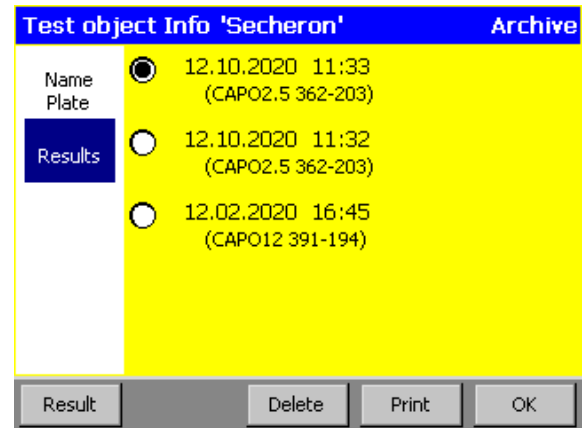

Test object Info 'Secheron'		Archive
Name	<input checked="" type="radio"/>	12.10.2020 11:33 (CAPO2.5 362-203)
Plate	<input type="radio"/>	12.10.2020 11:32 (CAPO2.5 362-203)
Results	<input type="radio"/>	12.02.2020 16:45 (CAPO12 391-194)

Buttons: Result, Delete, Print, OK

If you would like to see the actual measurement results, press the **Result** button on the bottom of the display.

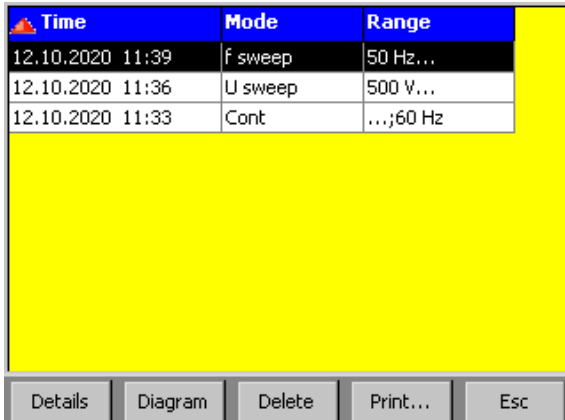

Time	Mode	Range
12.10.2020 11:39	f sweep	50 Hz...
12.10.2020 11:36	U sweep	500 V...
12.10.2020 11:33	Cont	...,60 Hz

Buttons: Details, Diagram, Delete, Print..., Esc

Select **Details** to show the results in the selected measurements

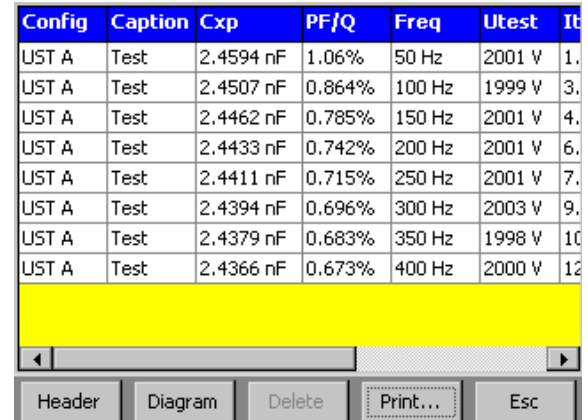

Config	Caption	Cxp	PF/Q	Freq	Utest	It
UST A	Test	2.4594 nF	1.06%	50 Hz	2001 V	1.
UST A	Test	2.4507 nF	0.864%	100 Hz	1999 V	3.
UST A	Test	2.4462 nF	0.785%	150 Hz	2001 V	4.
UST A	Test	2.4433 nF	0.742%	200 Hz	2001 V	6.
UST A	Test	2.4411 nF	0.715%	250 Hz	2001 V	7.
UST A	Test	2.4394 nF	0.696%	300 Hz	2003 V	9.
UST A	Test	2.4379 nF	0.683%	350 Hz	1998 V	10.
UST A	Test	2.4366 nF	0.673%	400 Hz	2000 V	12.

Buttons: Header, Diagram, Delete, Print..., Esc

Select one to e.g. delete or print it.  
 Press **Esc** to go back to the previous view.

Config	Caption	Cxp	PF/Q	Freq	Utest	It
UST A	Test	2.4594 nF	1.06%	50 Hz	2001 V	1.
UST A	Test	2.4507 nF	0.864%	100 Hz	1999 V	3.
UST A	Test	2.4462 nF	0.785%	150 Hz	2001 V	4.
UST A	Test	2.4433 nF	0.742%	200 Hz	2001 V	6.
UST A	Test	2.4411 nF	0.715%	250 Hz	2001 V	7.
UST A	Test	2.4394 nF	0.696%	300 Hz	2003 V	9.
UST A	Test	2.4379 nF	0.683%	350 Hz	1998 V	10.
UST A	Test	2.4366 nF	0.673%	400 Hz	2000 V	12.

◀
▶

Header
Diagram
Delete
Print...
Esc

### 8.3.3.1.1 Diagram

If the measurement has been made with a sweep function, it is possible to show the results in a diagram.

Select **Diagram** to show it.  
Change with the Tab between values of the PF or Cx.

With the **Print...** function you can print out or save the diagram.

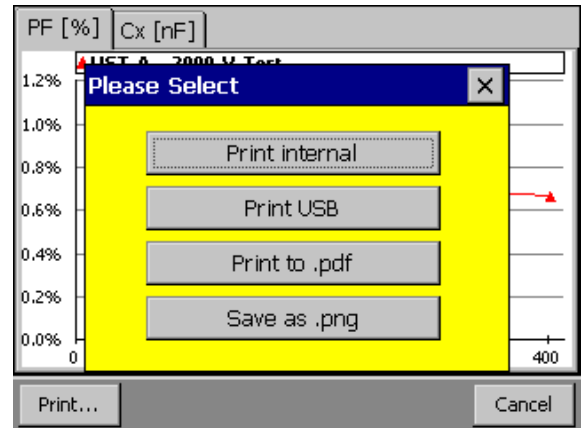
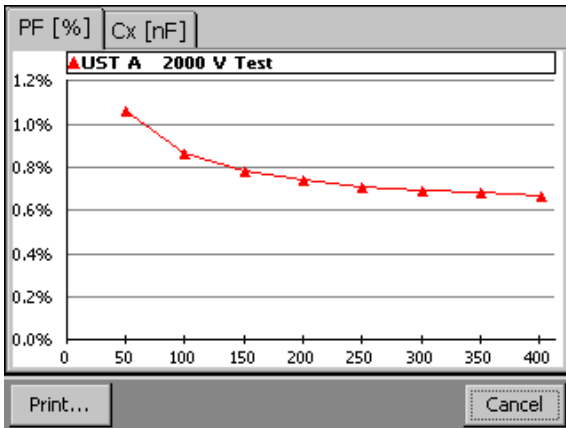

Select a measurement and press **Delete** to delete it.

Multiple selection is possible

Time	Mode	Range
12.10.2020 11:39	f sweep	50 Hz...
12.10.2020 11:36	U sweep	500 V...
12.10.2020 11:33	Cont	...;60 Hz

Details Diagram Delete Print... Esc

Time	Mode	Range
12.10.2020 11:39	f sweep	50 Hz...
12.10.2020 11:36	U sweep	500 V...
12.10.2020 11:33	Cont	...;60 Hz

Details Diagram Delete Print... Esc

With the **Print...** function, your selection is printed on internal or external printer (if connected). If no measurements are selected, the entire memory will be printed or exported.

Time	Mode	Range
12.10.2020 11:39	f sweep	50 Hz...
12.10.2020 11:36	U sweep	500 V...
12.10.2020 11:33	Cont	...;60 Hz

Please Select

Print internal  
Print internal compact  
Print USB  
Print to .pdf  
Export to .csv

Details Diagram Delete Print... Esc

With **Print...** it is also possible that all the measurements can be exported onto a USB-key in a pdf or csv-file.

The csv-file can be opened for example; with Microsoft Excel or LibreOffice Calc.

The file is named with CAPO, the serial number of the instrument, the test object and the date and time. You can locate the file in the directory: Raytech\EXPORT on the USB Key.

To select the CSV Separator, see chapter F.3 CSV Separator in the attachment on page 105.

## 9 Measurement Modes<sup>1</sup>

### 9.1 Overview

The CAPO has three measurement inputs: A, B and HV-GND.

Over an internal relays-matrix they are automatically combined for the different measurement modes as follows:

Mode	Measurement Inputs		
	A	B	HVGND
UST A	measured	guarded	guarded
UST B	guarded	measured	guarded
UST A+B	measured	measured	guarded
GST A+B	measured	measured	measured
GSTg A	guarded	measured	measured
GSTg B	measured	guarded	measured
GSTg A+B	guarded	guarded	measured

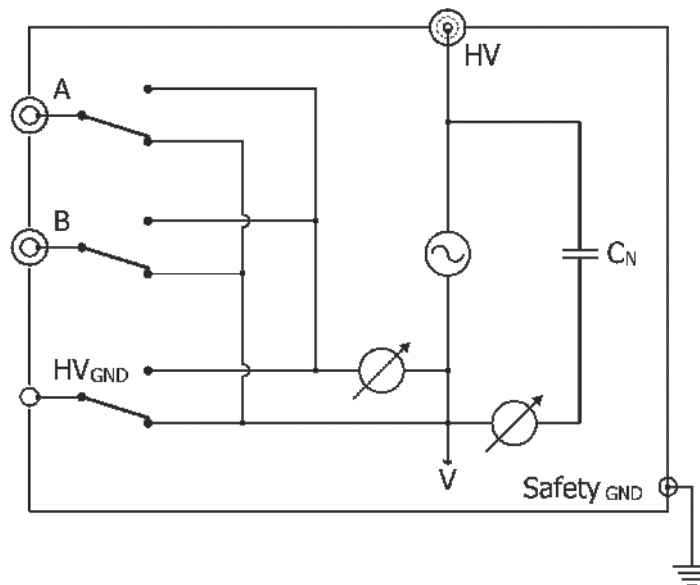

If the measured Input is guarded, it means that the input is internally connected to the so called “V”-potential which is the low voltage point (reference) of the high voltage supply. All currents that flow directly to this point will not be measured.

<sup>1</sup> According to ANSI/IEEE Standard 62, IEEE Std C57.152-2013



To eliminate the stray capacitances, you have to connect the unwanted capacitances to this point. V-potential terminal is also provided on instrument panel (See chapter 7.2 on page 38, 10:Guard(V))<sup>1</sup>.

The following figure shows an example of eliminating a stray capacitance of one bushing, which is caused by bushing surface leakage current. By using a conducting collar which is placed and tightened on bushing surface near the tank (not touching) and connected to guard, leakage current of bushing guarded will not measure.

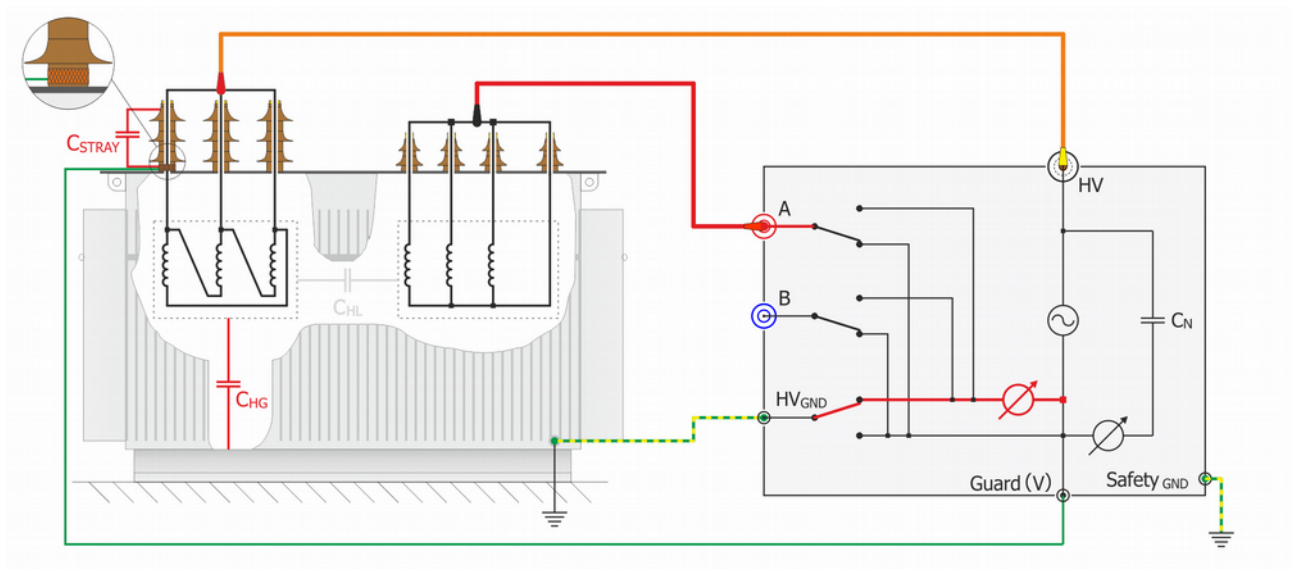

The shields of the measurement cables are also connected to this V-potential. Do not use unshielded measurement cables!

By selecting the different test modes, all combinations of measurements according the ANSI/IEEE Standard 62 can be measured without any rewiring.

<sup>1</sup> The CAPO 2.5 has no special terminal for the V-potential. But you can use the metal-housing of the plugs (HV, Input A, Input B), they have the V-potential.

## 9.2 UST Ungrounded Specimen Test

The UST configuration is used for measurements between two terminals of a test specimen that are not grounded or that can be removed from ground. In the UST configuration, current flowing in the insulation between the voltage lead and the measuring lead of the instrument is measured and current flowing to ground is not measured.

The below statements are to be taken as an example for transformers, a lot of different objects, such as CTs, PTs, switch gear, insulators, capacitors, bushings, motors or generators can be measured.

In the example below you measure the capacitance and dissipation factor between high-voltage winding (HV) and low-voltage winding (LV),  $C = C_{HL}$ .

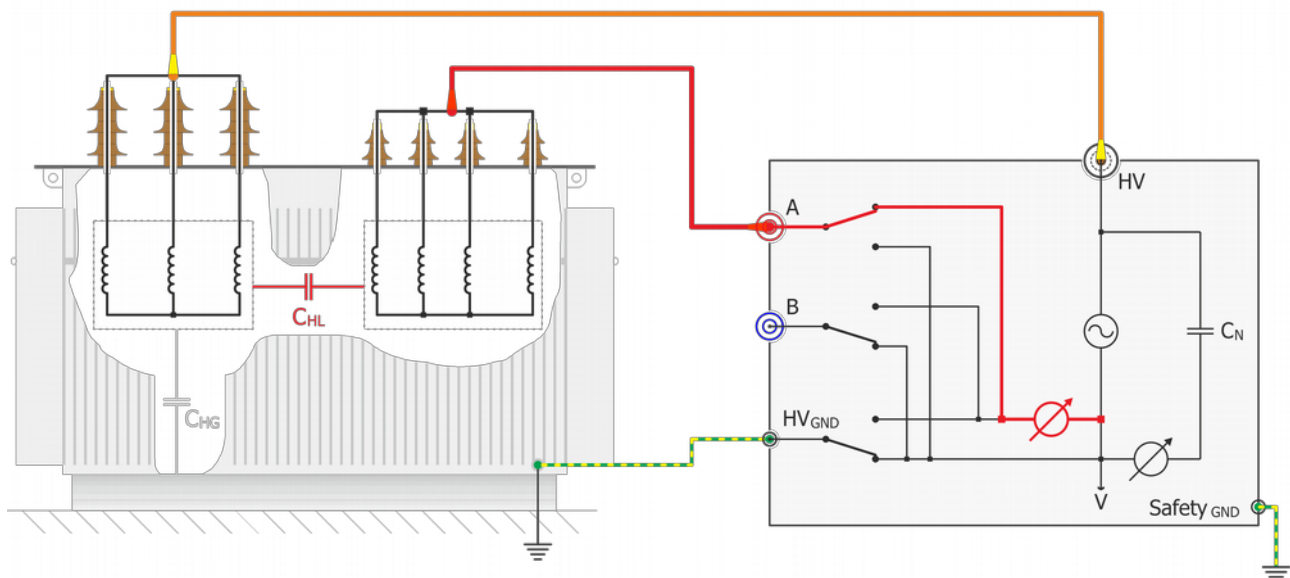

### USTA

Measurement of capacitance between high-voltage winding (HV) and low-voltage winding (LV), insulated from ground.

In the case of two low-voltage windings, either the individual capacitances or their sum can be measured via inputs A and B by setting the selector switch accordingly.

### 9.2.1 UST A

Ungrounded specimen test channel A, capacitance measured =  $C_A$ , ( $C_B$  and  $C_G$  guarded)

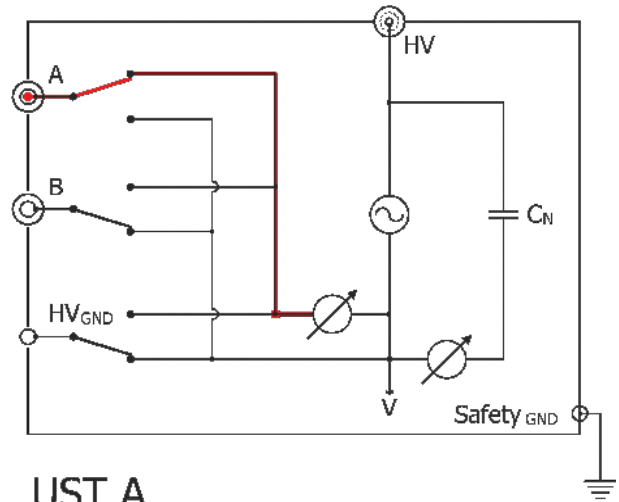
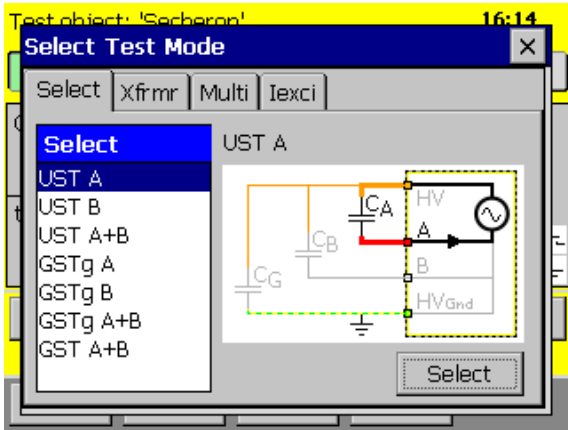

### 9.2.2 UST B

Ungrounded specimen test channel B, capacitance measured =  $C_B$ , ( $C_A$  and  $C_G$  guarded)

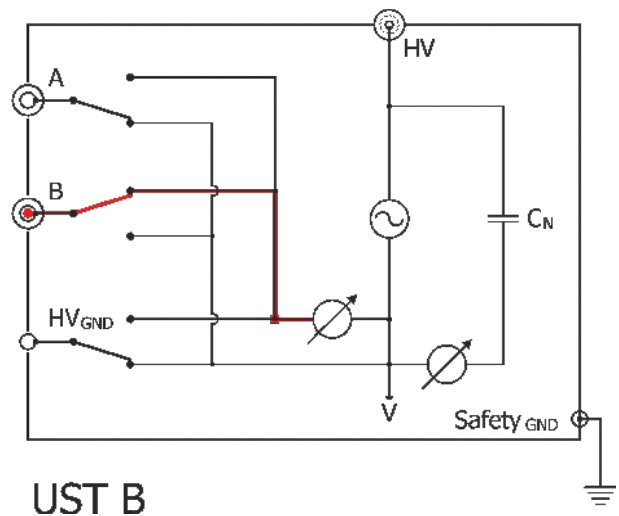
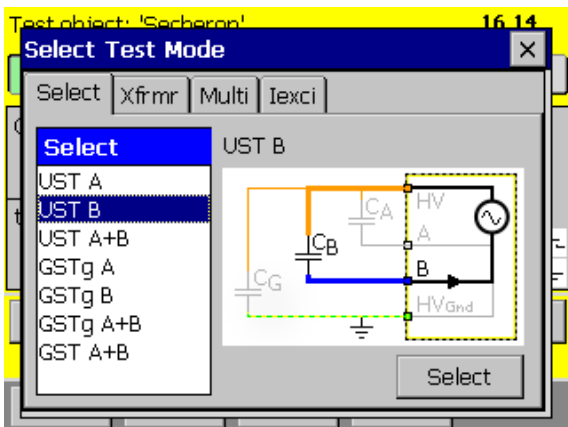

### 9.2.3 UST A + B

Ungrounded specimen test channel A + B, capacitance measured =  $C_A + C_B$ , ( $C_G$  guarded)

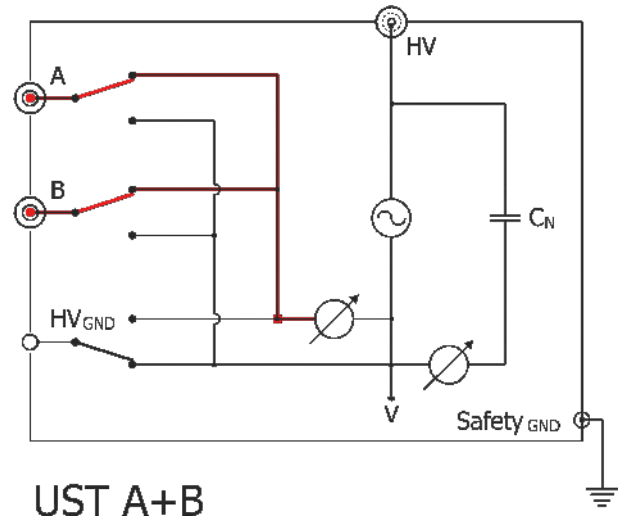
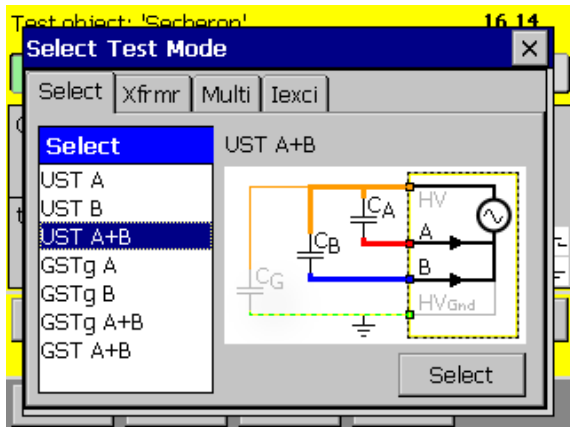

### 9.3 GST

The GST configuration permits testing of a grounded insulation specimen through the specimen's ground. All current flowing to ground is measured. The configuration is illustrated below:

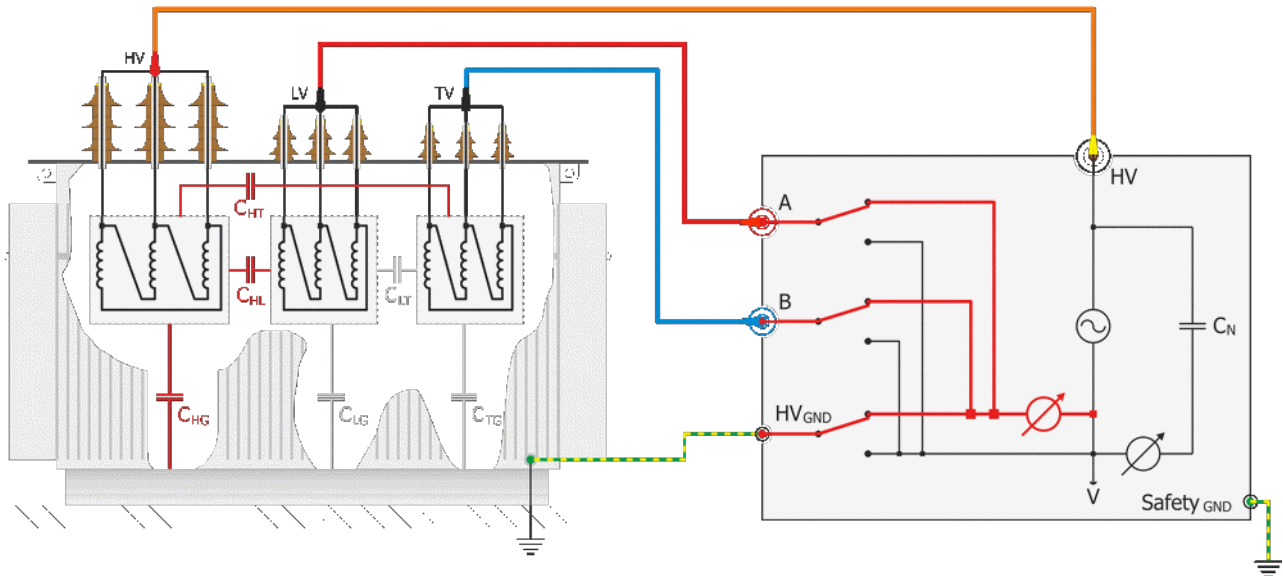

#### GST A + B

In the example above you measure the Capacitance and dissipation factor between HV and LV ( $C_{HL}$ ), HV and tertiary TV ( $C_{HT}$ ) and HV and tank ( $C_{HG}$ ). The total measured capacitance represents the sum of the three capacitances.

#### 9.3.1 GST A + B

Grounded specimen test channel A + B, capacitance measured =  $C_A + C_B + C_G$ .

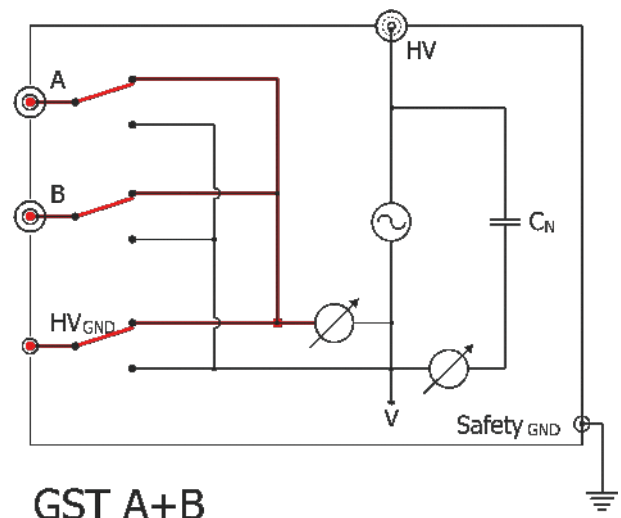
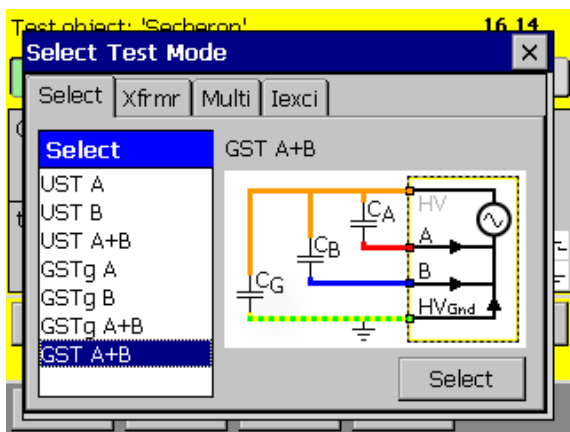

GST A+B

## 9.4 GSTg

The GSTg configuration allows unwanted currents, to bypass the measuring circuit and enables smaller sections of insulation to be tested individually. Only the ground currents are measured, using a GST-Guard configuration. Current flowing to terminals with the guard connection is not measured. This configuration is illustrated below:

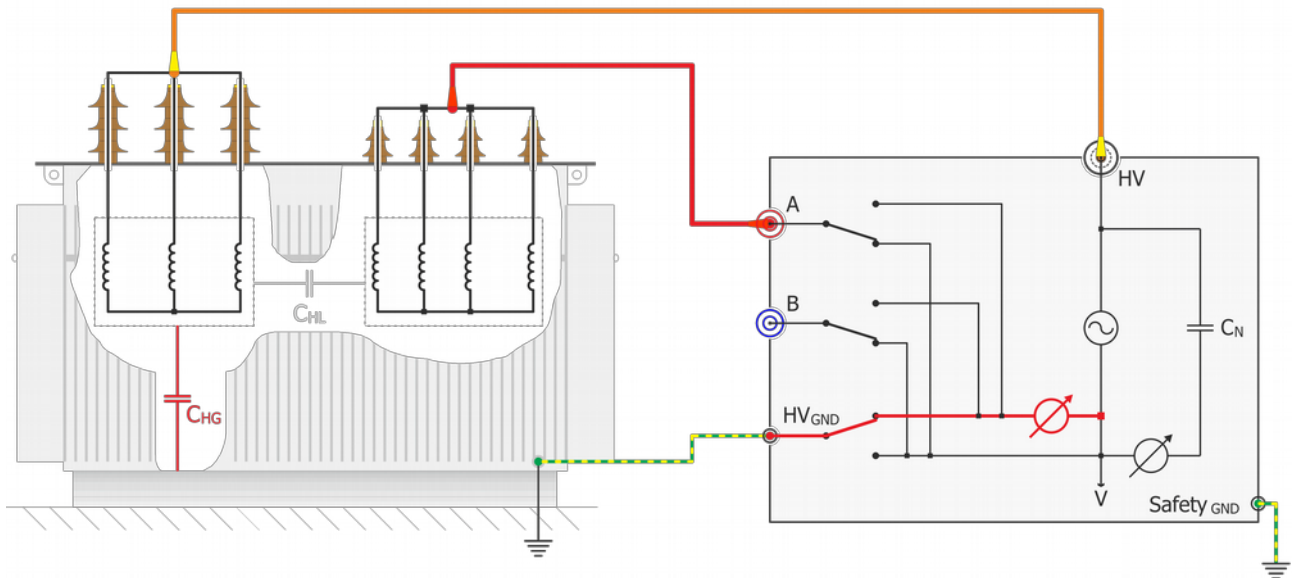

*GSTg A+B*

### 9.4.1 GSTg A

Grounded specimen test with guarded A (connected to V), capacitance measured =  $C_B + C_G$

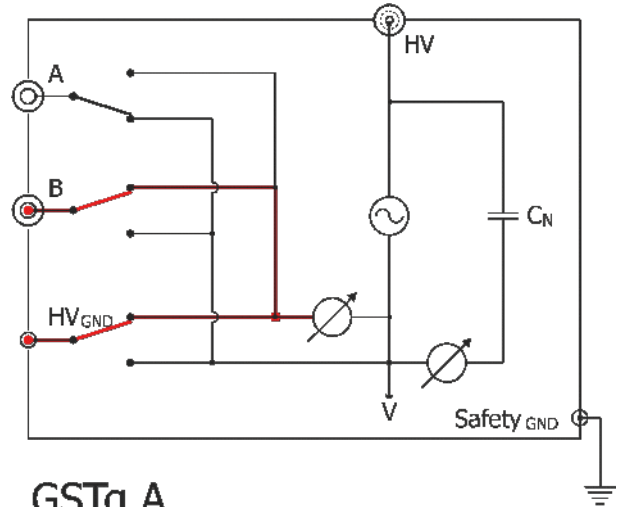
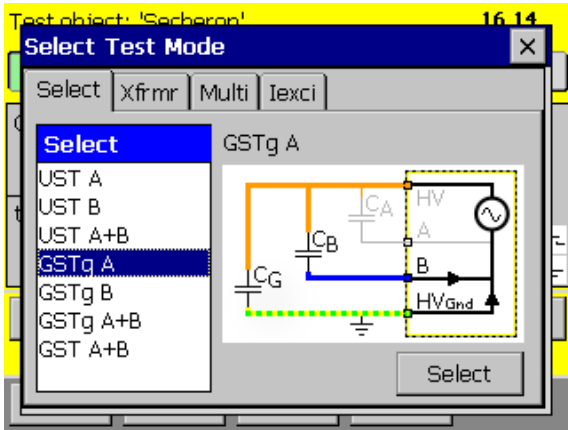

### 9.4.2 GSTg B

Grounded specimen test with guarded B (connected to V), capacitance measured =  $C_A + C_G$

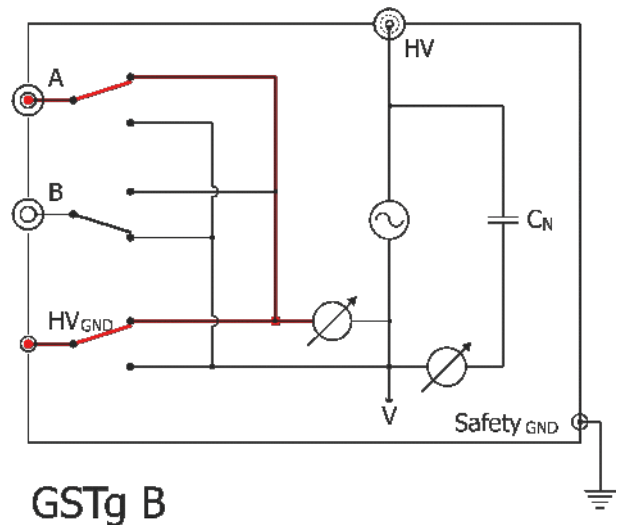
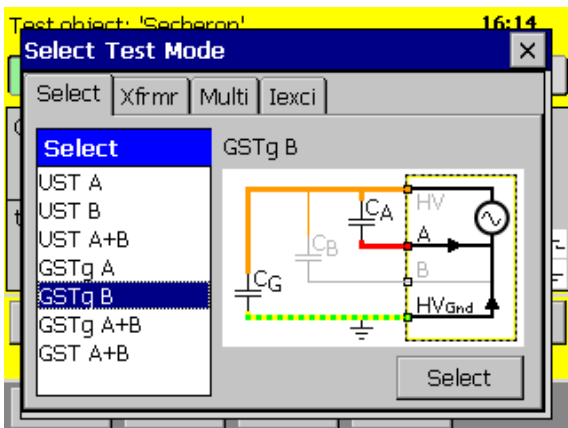

### 9.4.3 GSTg A + B

Grounded specimen test with guarded A and B (connected to V), capacitance measured =  $C_G$

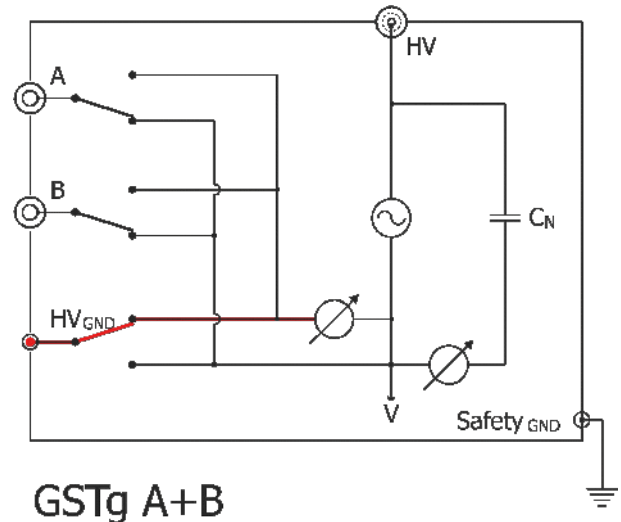
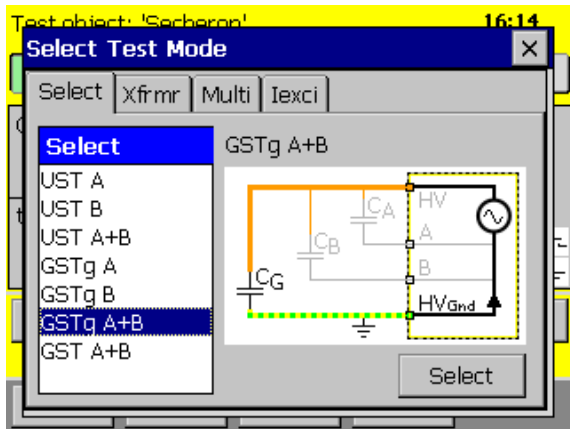



## 9.5 Xfrmr

The Transformer measuring mode is helpful to measure Transformers. According to IEEE Std C57.152-2013 the different capacitances with its deviation factors can be measured.

### 9.5.1 HL HV

Connect the high voltage from the CAPO to the shorten high voltage terminals of the transformer.  
 Connect the measurement Input A to the shorten low voltage terminals of the transformer.  
 If you start the measurement, it will do the following 3 measurements:

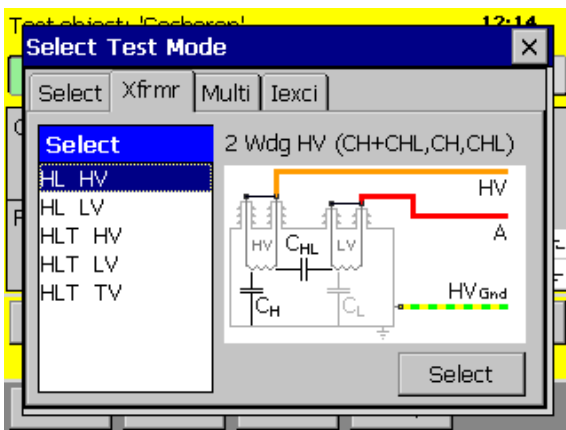

$$\text{GSTg B} \quad C_H + C_{CHL}$$

$$\text{GSTg A+B} \quad C_H$$

$$\text{UST A} \quad C_{CHL}$$

### 9.5.2 HL LV

Connect the high voltage from the CAPO to the shorten low voltage terminals of the transformer.  
 Connect the measurement Input A to the shorten high voltage terminals of the transformer.  
 If you start the measurement, it will do the following 3 measurements:

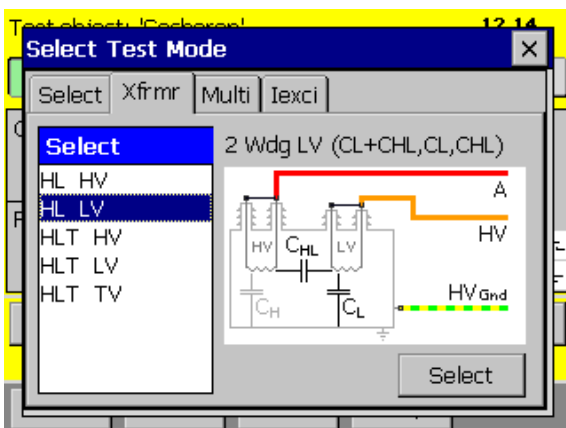

$$\text{GSTg B} \quad C_L + C_{CHL}$$

$$\text{GSTg A+B} \quad C_L$$

$$\text{UST A} \quad C_{CHL}$$

### 9.5.3 HLT HV

Connect the high voltage from the CAPO to the shorten high voltage terminals of the transformer.

Connect the measurement Input A to the shorten low voltage terminals of the transformer.

Connect the measurement Input B to the shorten tertiary voltage terminals of the transformer.

If you start the measurement, it will do the following 3 measurements:

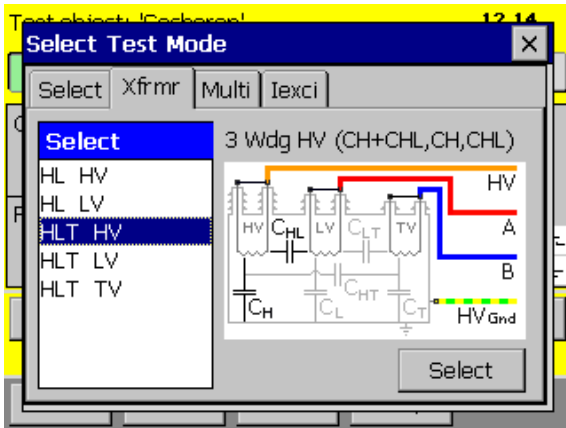

GSTg B  $C_H + C_{CHL}$

GSTg A+B  $C_H$

UST A  $C_{CHL}$

### 9.5.4 HLT LV

Connect the high voltage from the CAPO to the shorten low voltage terminals of the transformer.

Connect the measurement Input A to the shorten high voltage terminals of the transformer.

Connect the measurement Input B to the shorten tertiary voltage terminals of the transformer.

If you start the measurement, it will do the following 3 measurements:

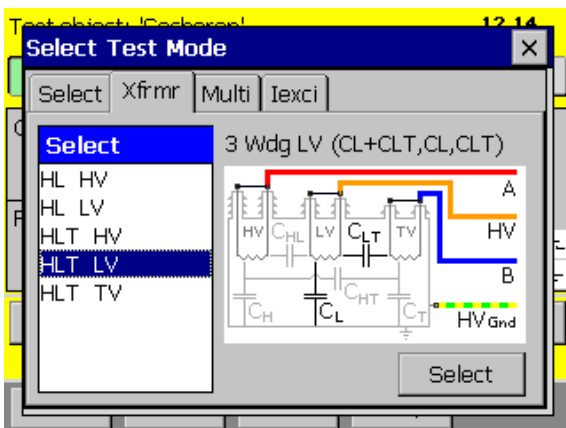

GSTg A  $C_L + C_{CLT}$

GSTg A+B  $C_L$

UST B  $C_{CLT}$

### 9.5.5 HLT TV

Connect the high voltage from the CAPO to the shorten tertiary voltage terminals of the transformer.

Connect the measurement Input A to the shorten high voltage terminals of the transformer.

Connect the measurement Input B to the shorten low voltage terminals of the transformer.

If you start the measurement, it will do the following 3 measurements:

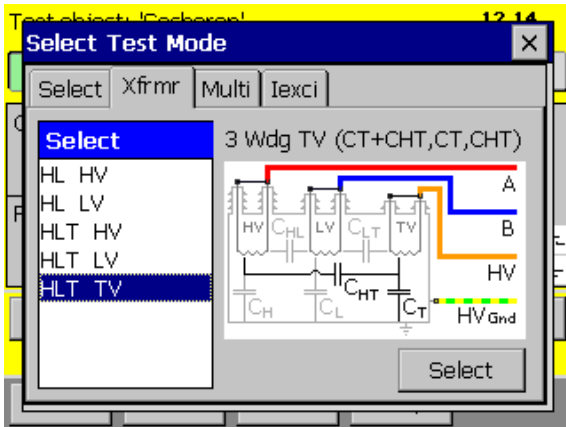

GSTg B       $C_T + C_{HT}$

GSTg A+B     $C_T$

UST A         $C_{HT}$

## 9.6 Multi

This Test Mode is useful to generate lists with measurement modes.  
The CAPO will do all the measurement according to the selected list.

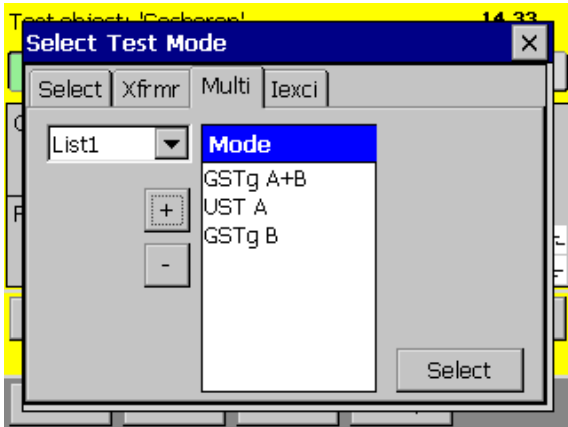

Use  or  to change the selected list

## 9.7 Excitation current<sup>1</sup> I<sub>exci</sub>

The excitation current test consists of a simple open-circuit measurement of the current magnitude and loss, typically on the HV side of the transformer, with the terminals of the other windings let floating (with the exception of a grounded neutral). Excitation current is measured at rated frequency and usually at voltages up to 10kV. Three-phase transformers are tested by applying a single-phase test voltage to one phase at a time.

The diagnostic analysis of excitation current test results is based largely on pattern recognition. Both current magnitude and loss depend on the transformer design and are unique for each unit. The results can also be used in comparison with previous data from tests performed at the same test voltage.

For the great majority of three-phase transformers, the pattern is two similar high readings on the outer phases and one lower reading on the center phase.



### WARNING !

Caution should be exercised in the vicinity of transformer terminals because voltage is induced in all windings during the test.

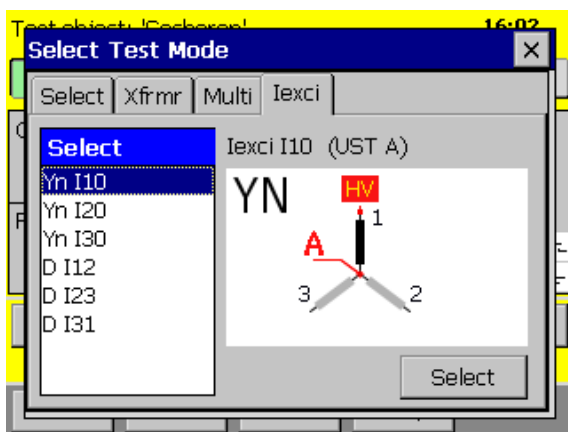

Select the connection and the phase to measure.

<sup>1</sup> According to IEEE C57.152

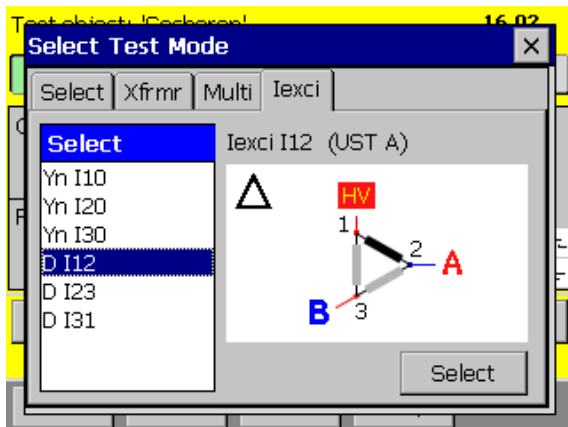

This is a sample for the delta connection



### INFO:

Residual magnetism may produce misleading excitation current values when these are used solely as a criterion of the condition of the magnetic circuit of a transformer. Although some residual magnetism is almost always present in the core, in most cases it has no significant effect on test results. If residual magnetism exists, then it is recommended that the core be demagnetized before performing the test. Often, residual magnetism is introduced as a result of a dc winding resistance test. It is recommended to perform excitation current tests before any test that may introduce residual magnetism.

## 10 Bushing Test

In this chapter, information regarding bushing power factor/  $\tan \delta$  measurement is provided.

According to IEEE C57.152-2013 standard, generally bushings are classified by design as:

- Condenser type
  - Insulating liquid-impregnated paper insulation, with interspersed conducting (condenser) layers or insulating liquid-impregnated paper insulation, continuously wound with interleaved lined paper layers
  - Resin-bonded
  - Resin-impregnated paper insulation, with interspersed conducting (condenser) layers
- Non-condenser type
  - Solid core or alternate layers of solid and liquid insulation
  - Solid mass of homogeneous insulating material (e.g., solid porcelain)
  - Gas filled

Condenser type bushing includes a series of concentric capacitors from centre conductor to ground. Some types also include a tap electrode near the ground flange. In the picture below, a schematic of high voltage bushing can be seen.

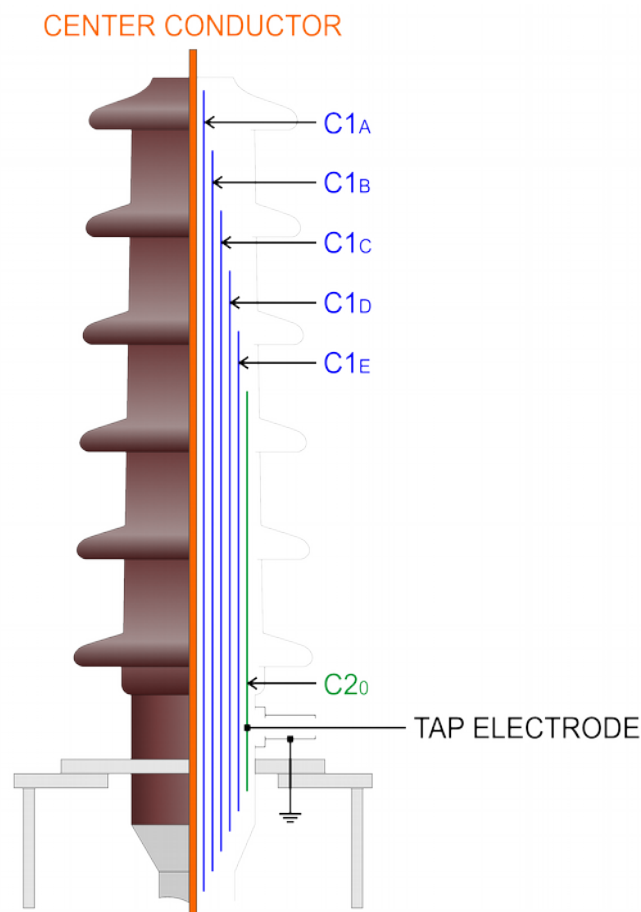

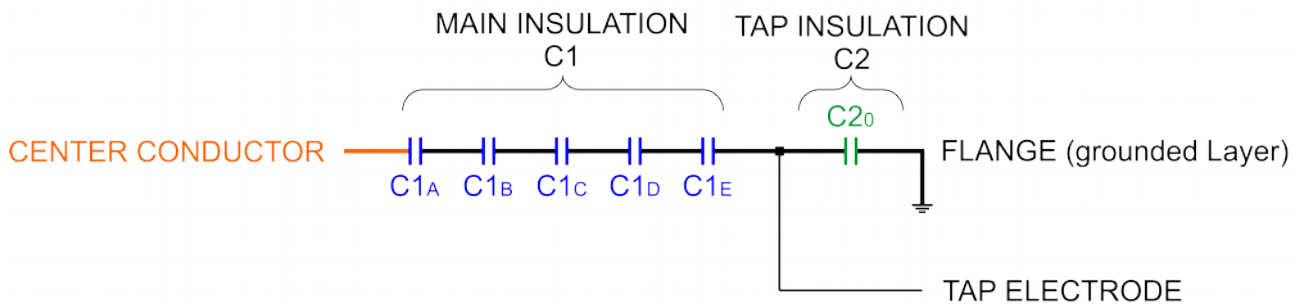

By considering the design of high voltage bushing and with various measurement setups, following tests can be performed:

- Overall test to measure insulation between centre conductor and ground flange including C1 and C2.
- Main insulation test to measure insulation between centre conductor and tap electrode including C1.
- Tap insulation test to measure insulation between tap electrode and ground flange including C2.
- Hot collar test to measure insulation losses of a small section of the bushing.

If the bushing under test is installed on a transformer, in order to reduce the influence of winding's inductance on measurements, all terminals of each voltage level of the transformer should be shorted together and those transformer sides which not energized should also be grounded for the safety.

In order to test the bushing precisely, bushing surface should be cleaned. Dust and particles can affect the measurement results, specially when the bushing is wet.



## 10.1 Bushing Overall test

The following picture illustrates the measurement setup for overall test of a bushing. In this method the insulation between centre conductor and ground which includes both C1 and C2 can be measured. Please note that this test is useful if the bushing under test is isolated and not installed on an equipment such as transformer; otherwise all insulations between centre conductor and ground would be included in measurement values. This method can be used for all various type of bushings including condenser types with or without tap electrode and also non-condenser types.

For this test the GSTg A+B mode should be selected.

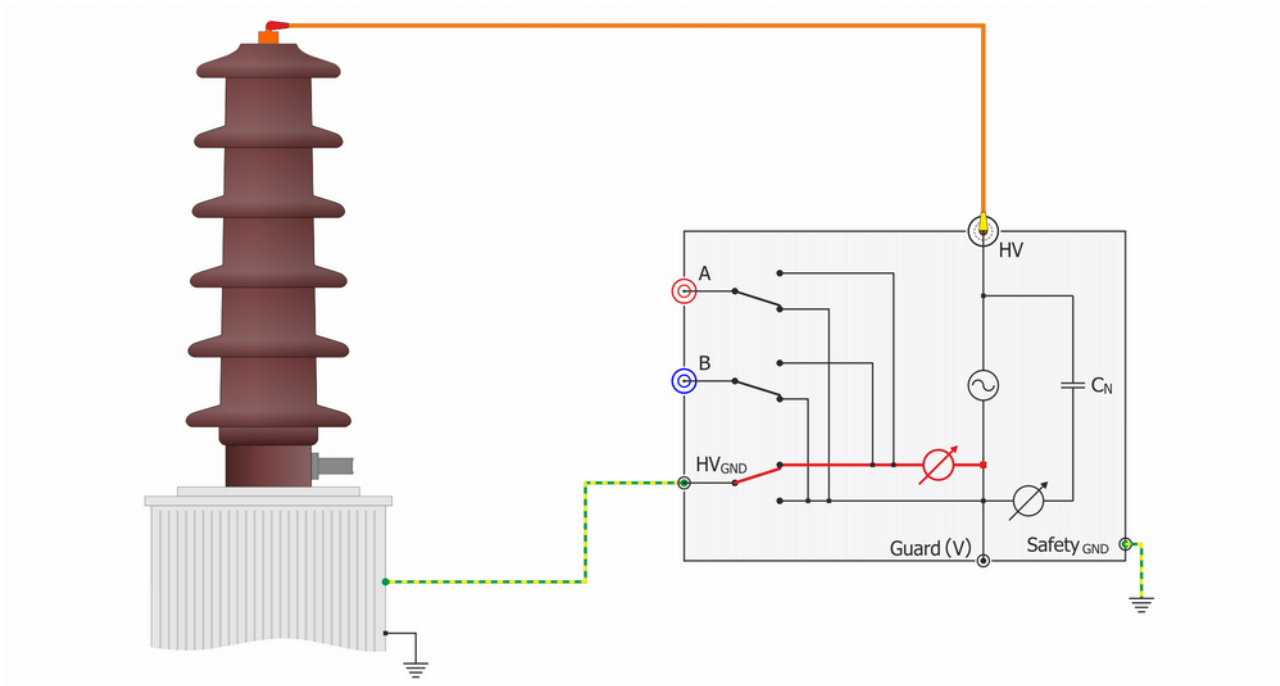

### NOTE:

The bushing overall test is useful if the bushing under the test is isolated and not installed on an equipment such as transformer; otherwise all insulations between centre conductor and ground would be included in measurement values!

## 10.2 Bushing main insulation test

The following picture illustrates measurement setup for main insulation test of a bushing. In this method the insulation between centre conductor and tap electrode which includes C1 can be measured. This method can be used only for bushings with tap electrode.

For this test the UST A mode should be selected.

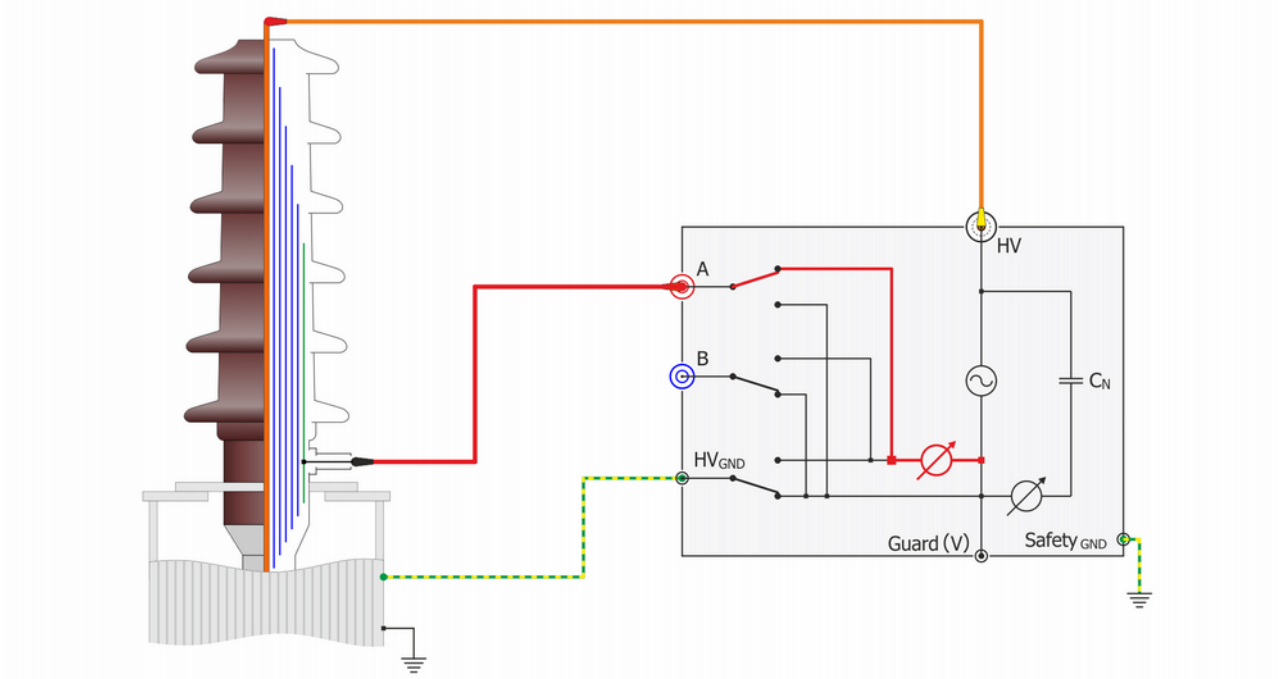

### 10.3 Bushing tap insulation test

The following picture illustrates measurement setup for tap insulation test of a bushing. In this method the insulation between tap electrode and ground flange which includes C2 can be measured. This method can be used only for condenser types bushings with tap electrode.

For this test the GSTg A+B mode should be selected.

Please note that the test voltage must not exceeds the permissible level which defined by bushing manufacturer. If the permissible maximum test voltage is not clear, do not adjust the output voltage more than 500 V.

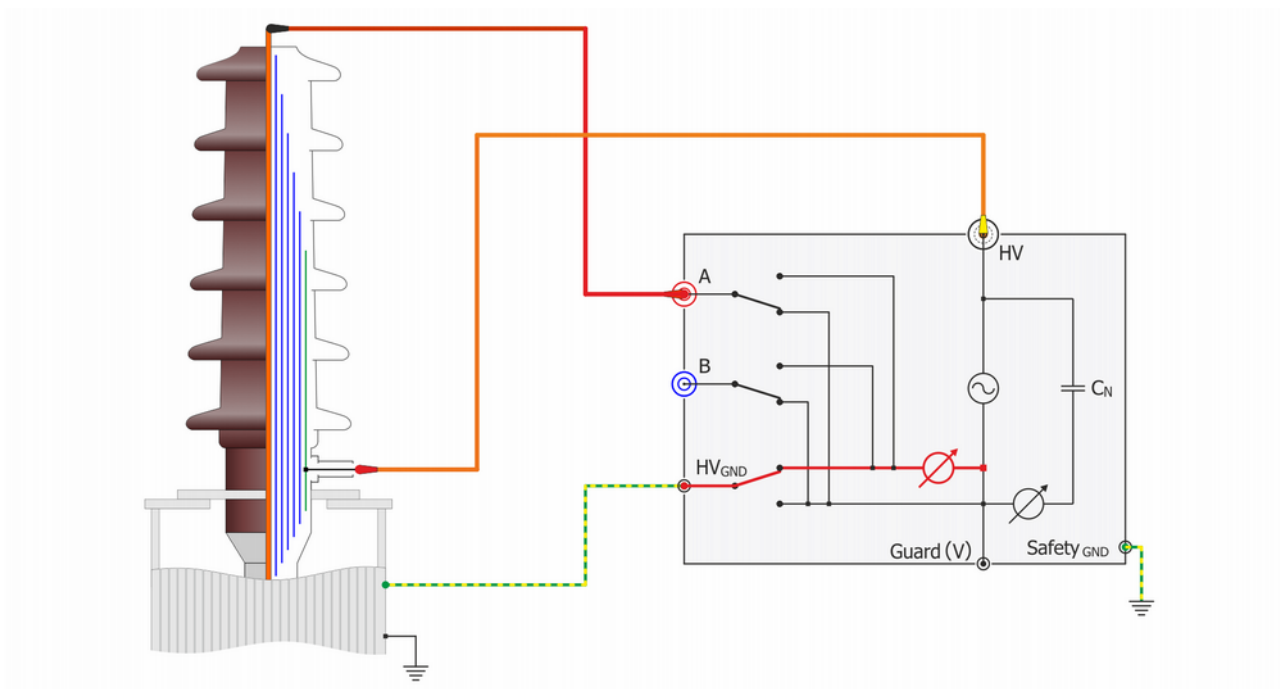

#### **WARNING !**

In bushing tap insulation test, the test voltage must not exceeds the permissible level which defined by bushing manufacturer.

## 10.4 Bushing hot collar test

The following picture illustrates measurement setup for hot collar test to measure insulation losses of a small section of the bushing. This test is useful when the bushing is not equipped with a tap electrode and can be used to locate probable cracks in porcelain or insulation problems.

For the test setup, at first, a conductive hot collar band must be fit tightly to the surface of bushing, mainly near the top, then test cables must be connected according to the following picture.

For this test the UST A mode should be selected.

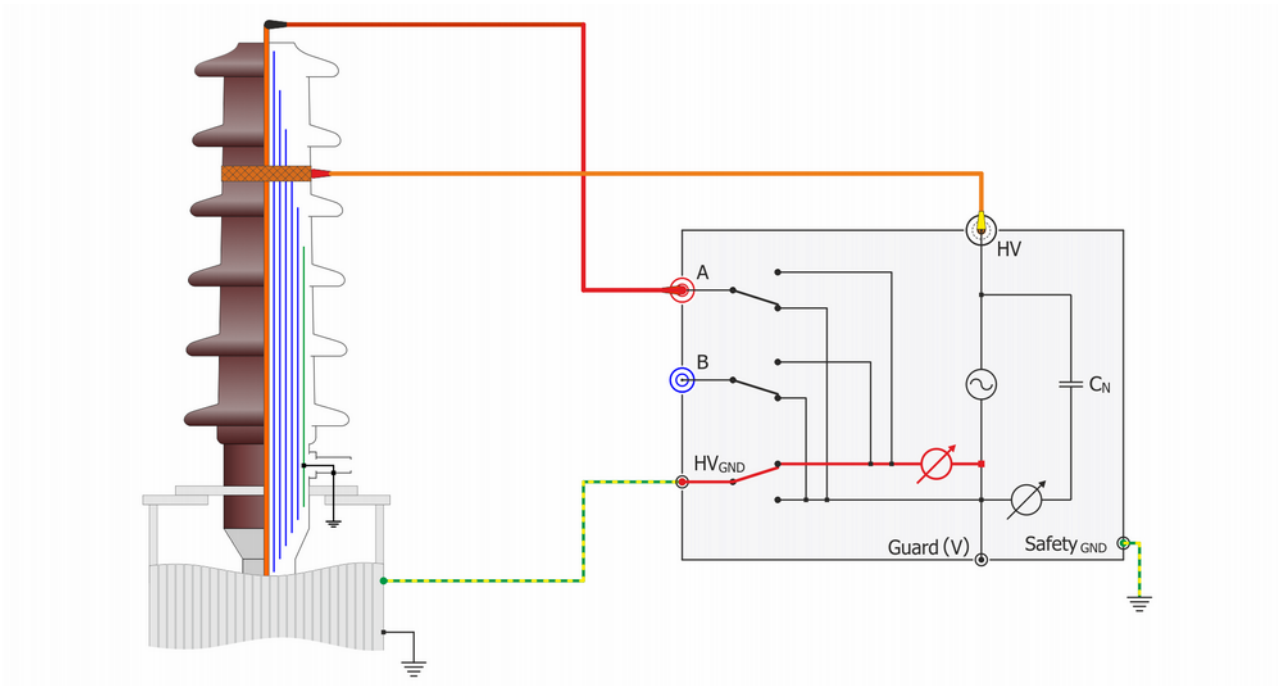

If the current or watts-loss is appreciably higher than normal, move the collar one petticoat down and do another test. Repeat this procedure and move the collar as far down as necessary to determine how far down the fault has progressed.

# 11 Interfaces

## 11.1 Hardware

### 11.1.1 RS 323

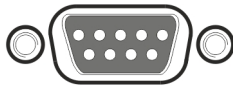

RS 232

1 x RS 232, 9 Pin

Pin 2 TxD (CAPO-> Host)

Pin 3 RxD (Host-> CAPO)

Pin 7 GND

Interface Parameters (fixed, unchangeable):

Port	RS232
Baudrate	38400 Baud
Databit	8Bit
Stopbits	1Bit
Parity	No

### 11.1.2 USB

USB-Master (Standard 2.0)

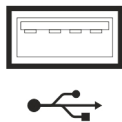

USB-Slave (Standard 2.0)



### 11.1.3 Safety

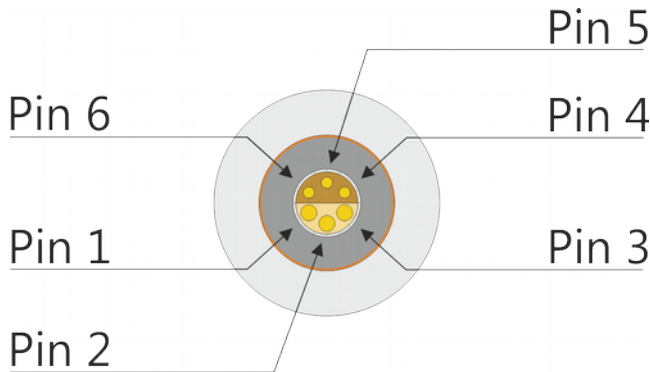

This is the plug for the Safety-Switch

## Safety

Front View

**Pin 5 and pin 6** are part of the extended safety circuit. When these contacts are open the instrument acts as if the emergency stop has been pressed.

If you press the Safety-Switch, pin 5 and 6 will be closed.

You can use **pin 3 and pin 4** to connect an external Warning Light or Beeper to indicate a dangerous condition.

There is an internal Relay whose contact is connected to the plug "Safety".

An external power source and a Warning Light or Beeper may be connected to pins 3 and 4 to indicate a dangerous condition. See: Example for connecting an external warning device below.

Use the working contact between Pin 3 and Pin 4, maximum Load 240VAC 2A.



The contact is open when the system is Safe.

The contact is closed when the system is Unsafe.

**Pin 1 and pin 2** on the Safety connector: These pins are for Raytech Service use. Do not connect anything to these pins!

### 11.1.4 Temp

This is the plug for an external temperature probe.

Connect the TP 01 from Raytech and the CAPO will display the actual temperature and store it together with the test results.

The Temperature Sensor Cable (TP-01) is not a standard delivery. The optional part can be ordered at your local Raytech representative.

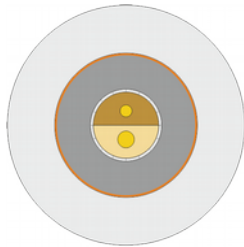

## Temp

Front View



### Technical Specification of the External temperature probe (TP-01)

Order number:	30074 TP 01
Cable length:	10m
Temperature range:	-20° ... 110°C
Accuracy (0 ... 70°C):	0.2K
Sensor:	B57863S103F40 B <sub>25/100</sub> 3988K R <sub>25</sub> 10kΩ
Plug (cable):	Lemo FFA.1E.302.CLAC65
Socket (instrument):	Lemo ERA.1E.302.CLL
Set of 2 probes:	TP 02
Set of 3 probes:	TP 03



# Appendix

## **CAPO 2.5 /** CAPACITANCE AND POWER FACTOR METER



# Appendix

<b>A Raytech T-Base</b>	<b>95</b>
A.1 T-Base Lite.....	95
A.2 T-Base Pro.....	95
<b>B System Update</b>	<b>96</b>
<b>C Software Development Kit (SDK)</b>	<b>97</b>
<b>D Command Syntax</b>	<b>98</b>
D.1 Raytech USB/Serial Port Driver.....	98
D.2 Command Syntax.....	98
D.3 Answer-codes.....	98
D.3.1 Synchronous Answers.....	98
D.3.2 Asynchronous Answer.....	99
D.3.3 Serial Interface.....	99
D.4 USB Interface.....	99
<b>E USB Printer Info</b>	<b>100</b>
E.1 Printer Requirements.....	100
E.2 Suggested Printers.....	100
<b>F Service Mode</b>	<b>101</b>
F.1 Calibrate Touchscreen.....	101
F.2 Show Ground Warning.....	102
F.3 CSV Separator.....	102
F.4 Raytech USB Driver.....	103
F.5 Show Series Values.....	103
F.6 Oil Correction Table.....	104
<b>G Error Messages</b>	<b>106</b>
<b>H Trouble Shooting</b>	<b>108</b>
H.1 Touch Panel does not work.....	109
H.2 USB Memory Stick does not work.....	109
<b>I Warranty Conditions</b>	<b>110</b>
I.1 Limitation of Warranty.....	110
I.2 Arbitration.....	111
<b>J Contacts</b>	<b>112</b>
<b>K Index</b>	<b>113</b>

## A Raytech T-Base

### A.1 T-Base Lite

T-Base Lite is intended for users preferring simplicity over complexity of the Pro version. It is limited to the basic functions of USB interface, data import from device, data export to filesystem, and automatic firmware updates. Data can be exported in many popular data formats such as excel, word, text, .csv, .xml, crystal reports, and .html. Measurements can be saved as archive files as well and imported into the database of the T-Base Pro version. This software is as download available and completely free.

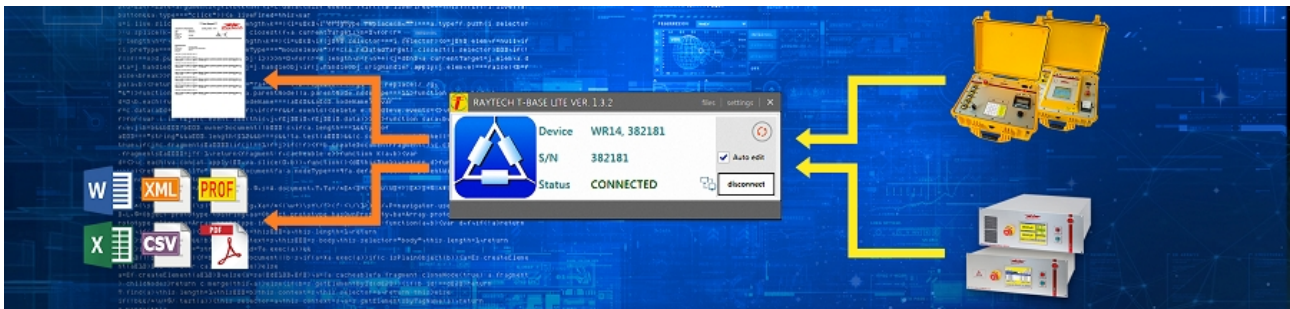

### A.2 T-Base Pro

T-Base Pro is a powerful set of tools for data exchange, remote control, visual measurement data analysis, test automation and much more. It comes with a fully integrated database management system for storing measurement data as well as with a fully customizable reporting system which can generate test reports in the most widely used document formats. It uses an advanced add-on system which makes it suitable for integration with external systems. To extend according to your needs a rich API interface and MS Visual Studio templates are available.

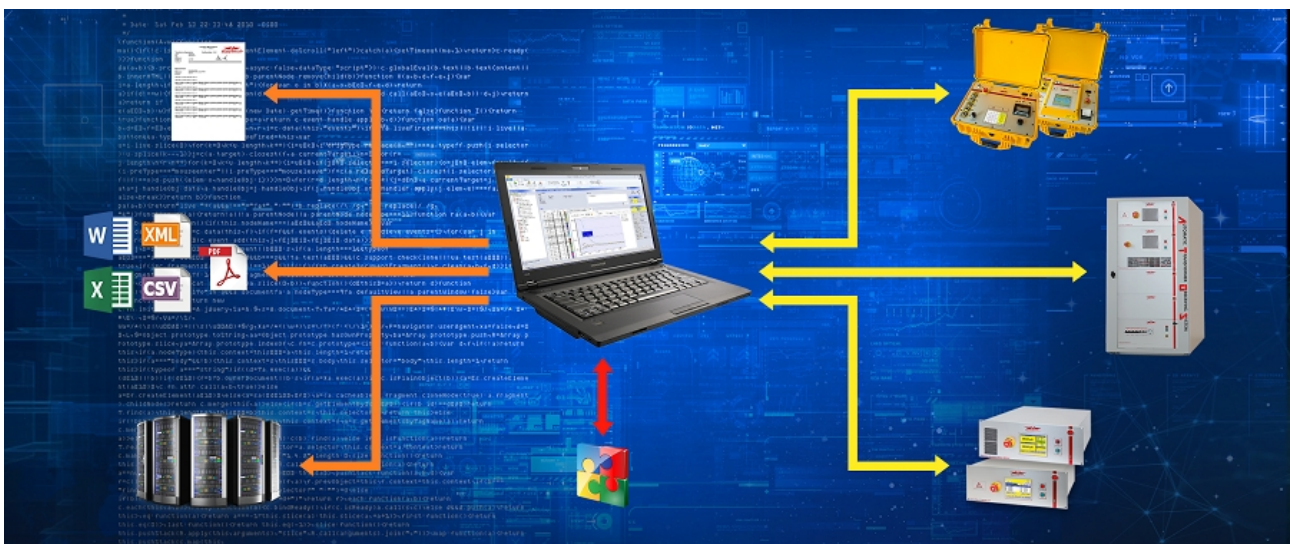

More information on Raytech homepage.

## B System Update

System firmware upgrades are available at no charge from the web site [www.raytech.ch](http://www.raytech.ch)

This firmware is downloaded to a Windows based computer and then can be used with an USB Stick to upgrade the CAPO.

Download the new Firmware (.zip file) onto your USB key on the root directory (Not in a sub-directory and do not Unzip it).

The CAPO 12 will automatically ask for an update, when the USB Stick is plugged to your Instrument. For further details please contact our support group.

Check also chapter 8.2.7.1.5 Update on page 60.

## **C Software Development Kit (SDK)**

The SDK is a device management software with various possible applications. It is essentially a software layer (or driver) that resides between the Operating System (OS) IO system, custom Windows Application and Raytech instruments. The SDK with native Raytech USB Driver for Windows provides the OS with full device functionality, appearing to OS as a Raytech USB device. This software can also be used without native Raytech USB drivers to control the device over the standard RS-232 serial port.

It is a powerful tool to write easily customized Software to control the Raytech Instruments.

## D Command Syntax

It is possible to control the instrument over the RS232 or the USB port with an external computer. It is also possible to write your own test program for a fully customized test procedure.

A description of all commands (90235 Command Set CAPO) and more details is stored on the delivered USB-Key. The newest version can always be downloaded from the internet at [www.raytech.ch](http://www.raytech.ch).

### D.1 Raytech USB/Serial Port Driver

Raytech is providing a SDK for Software integrations in .NET Projects. For more information have a look at chapter C Software Development Kit (SDK) on page 100.

### D.2 Command Syntax

Cmd [Para[,Para2..]] LF"

Separator for Cmd and Parameters ' ' (space 0x20)

Separator for Parameters: ','

Numeric Format of Numbers: float ( C - Language), "." as decimal point

Format of Strings: all ASCII Characters from 0x20 to 0x7f]

### D.3 Answer-codes

#### D.3.1 Synchronous Answers

Answer to a command:

Response Code	Remarks
"*0 ok"	Ok
"*1 unkn"	Unknown Command
"*2 Error"	Syntax Error
"*3 Emerg"	Emergency is pressed
"*4 Range"	Parameter is out of range
"*5 Missing Parameter"	Missing Parameter
"*7 Internal"	Internal Error
"*99 No Authorization"	Invalid License

### D.3.2 Asynchronous Answer

Events/Redirected Messages:

Response Code	Remarks
"@*10 Exc, "	Redirected Exception, e.g Over current
"@*11 Err, "	Redirected Error
"@*12 Wrn, "	Redirected Warning
"@*13 Msg"	Redirected Message, Status
"@*15 Settings, "	Redirected Settings Message
"@*19 Set to Local"	"Local" Button pressed on the CAPO
"@*20 Start"	Measurement started
"@*21 End"	Measurement stopped
"@*R0, "	Results formatted value with unit
"@*R1, "	Results formatted as float

### D.3.3 Serial Interface

Interface Parameters

Parameter	Value
Port	RS232
Baudrate	38400Baud
Databit	8 Bit
Stopbits	1 Bit
Parity	No
TxD (CAPO-> Host)	Pin 2
RxD (Host-> CAPO)	Pin 3
Gnd	Pin 7
Signal	+/- 12V

### D.4 USB Interface

To communicate with the CAPO over USB it is necessary to switch to Raytech Driver Mode.

Enter Service Code "2001" to set USB Driver Mode. This is normally already done. For more information have a look at chapter F.4 Raytech USB Driver on page 106.

## E USB Printer Info

### E.1 Printer Requirements

The Printer must conform to Standard USB class 7.1 device. Nearly every Printer conforms as such with the exception of multifunction devices (e.g. All in One Printers).

Supported Languages are:

- HP PCL
- Epson ESC/P 2
- Epson Stylus COLOR
- Canon BJ (300 dpi)
- Canon BJ (360 dpi)
- Epson LX (9-pin)

### E.2 Suggested Printers

Table Suggested Printers:

<b>Ink-Jet</b>	<b>Laser</b>
Canon iP90	Brother HL-5240 (Tested)
Epson Stylus S20	Brother HL-2140
HP-Deskjet 6940	Brother HL-5240L
HP-Deskjet H470B	HP-Laserjet P1505N
HP-Deskjet H470WBT	HP-Laserjet P2055DN
Epson Stylus Office B40W	HP Color Laserjet CP2025N
	PocketJet 200
	PocketJet II

The information in this document is subject to change without notice.

## F Service Mode

The Service Mode has limited access. There are several codes accessible for setting parameters.

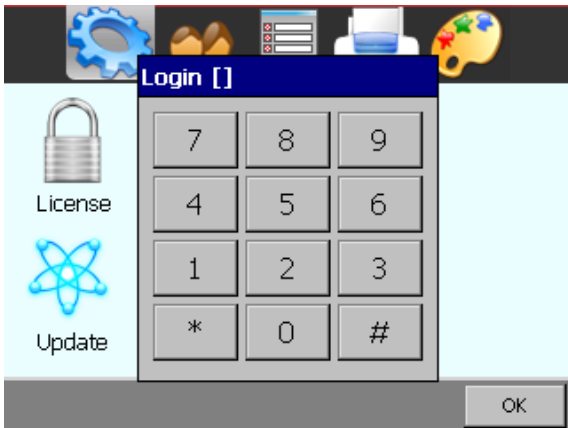

From the main screen tap 'Setup'. Then in the General screen press 'Service'. Enter the corresponding code or Exit by tapping '#'.  
#

### F.1 Calibrate Touchscreen

The touch screen parameters can be calibrated by the end user. Enter code **0000#** and follow the instructions on screen as depicted below.

You will see the following screen:

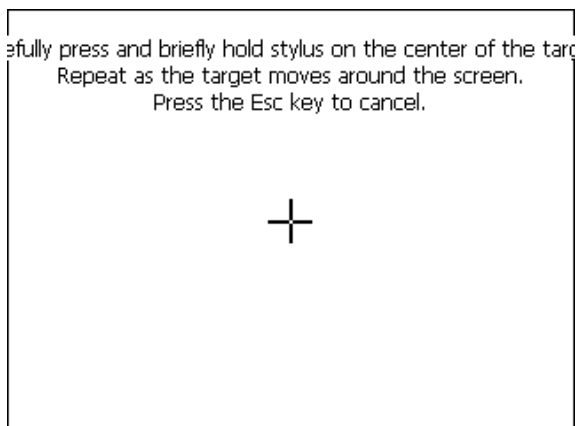

Press and hold stylus on the Center of the target until the cross moves.

Repeat as the target moves around the screen.

If a keyboard is connected, press Enter to accept the new parameters or ESC to escape.

If a keyboard is not connected, tap anywhere on the screen to accept the new parameters.



## F.2 Show Ground Warning

Enable or disable the warning message, when the instrument is powered on, by entering the Service Code **0200#**

Select **Yes** to enable the message  
 Select **No** to disable the message.

If the warning message is enabled, it will be displayed at every boot-up of the instrument and the message must be acknowledged to continue.

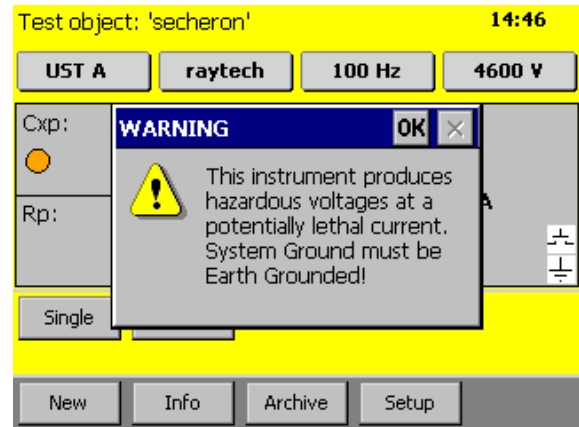

## F.3 CSV Separator

For the export of the data in a csv-file<sup>1</sup> you are able to change the separator.

You can set the CSV Separator with the following Service Codes:

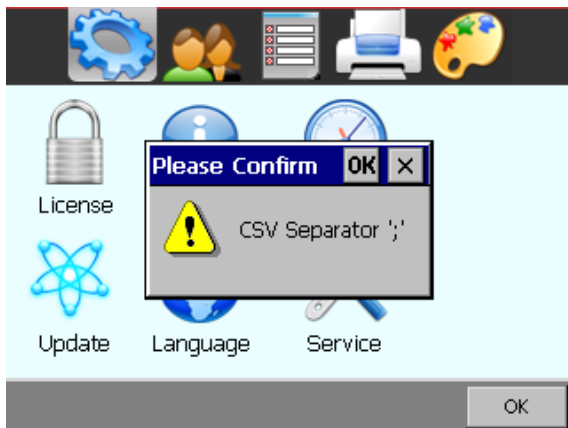

- CSV Separator ';' Code **2010#** (as seen in example)
- CSV Separator ',' Code **2011#**
- CSV Separator '\t' Code **2012#**

<sup>1</sup> Have a look on page 67 how to export the data in a csv-file.

## F.4 Raytech USB Driver

If you would like to send commands to the CAPO over the USB-port, you have to activate the Raytech USB driver.

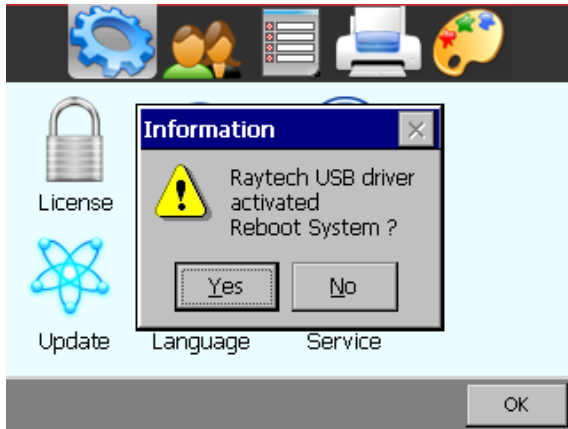

Use the Service Code '**2001#**' to do so, but normally it's already done

## F.5 Show Series Values

With the service code "**125#**", the CAPO shows the series values additionally of the equivalent circuits:

Activate this function with the Service Code 125#, the following window will show, tap **Yes**

In the main screen, a new Values will appear over your measurement data

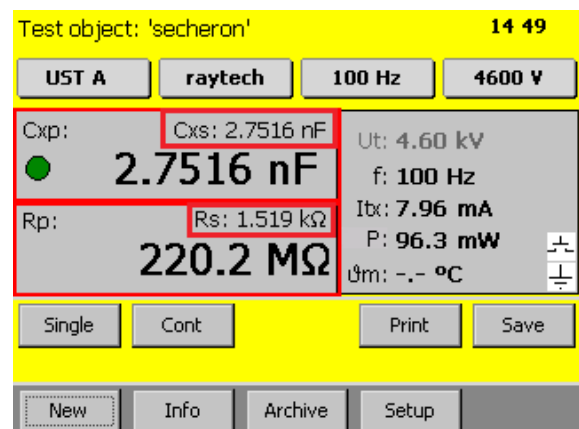

Have a look at chapter "6.2.2 Equivalent circuits" on page 27 for background information.

The Service Code is not persistent, you have to re-enter the code after restarting the CAPO.

## F.6 Oil Correction Table

In the Setup it is possible to make a measurement correction of the PF /  $\tan \delta$  on the basis of the temperature.

To access this feature, you have to enter the service code “1200#” first.

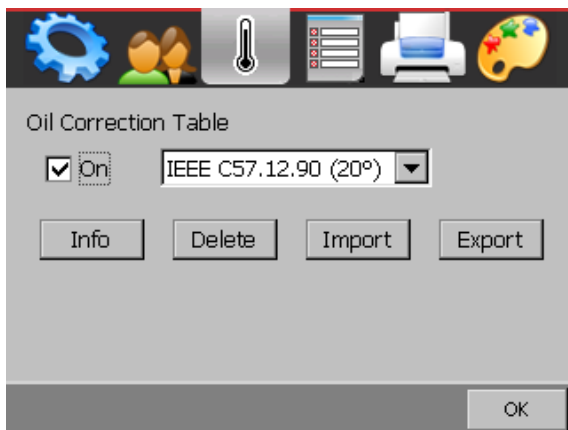

In the Setup you have access to this menu. Here you can activate it and choose the correction table.

With **Info** you see the table on the screen.

**Delete** will delete the selected table.

Use **Import** / **Export** to exchange tables with the connected USB-key.

The file looks like IEEE C57.12.90.oct<sup>1</sup>. It is on the root of the USB-key. You can edit the file e.g. with a text editor, Microsoft Excel, Libre Office Calc etc.

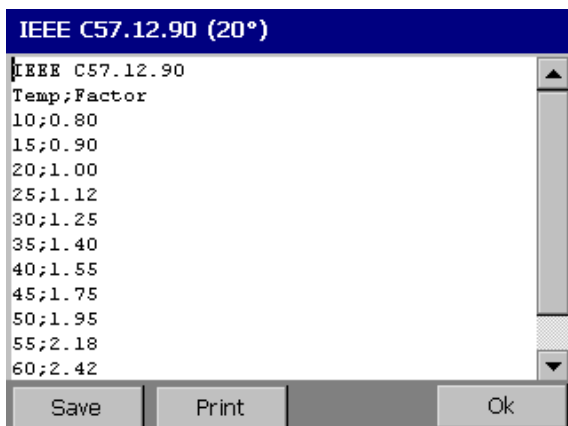

This is an Example of an Oil Correction Table.

It is possible to add customer tables tailored to the specific oil or test object.

<sup>1</sup> The standard table was from the IEEE C57.1290, you see the correction factor for the tan delta at the specific temperature (between it's an interpolation). This table is depending from the test object and it's not really an accurate correction. Now it's not any more in this standard, but some customers still want to have it, that's why we use a service code for it.

If the Oil Correction Table is activated, you have to connect the Temperature Probe to measure the oil temperature or enter the oil temperature manually. For that just tap on the main screen on  $\vartheta_m$ : -- °C.

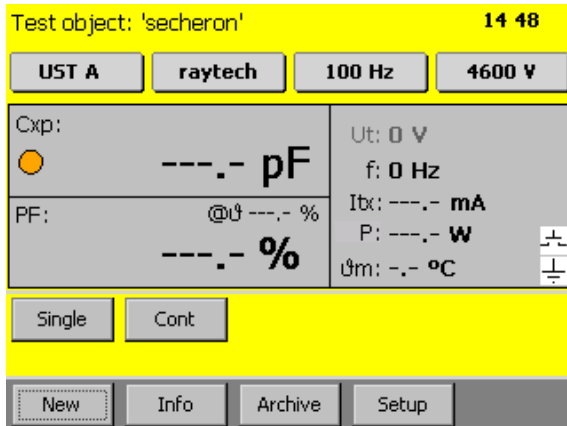

Over the measured  $\tan \delta$  the calculated  $\tan \delta$  is written in small letters @ $\vartheta$  --.-%.



**INFO:**

Take care if you use the oil correction table. It is depending on your testobject.

## G Error Messages

Raytech instruments are designed to be precise, rugged and trouble free. In most cases, many operators will never see any error messages.

Below is an example of a message:

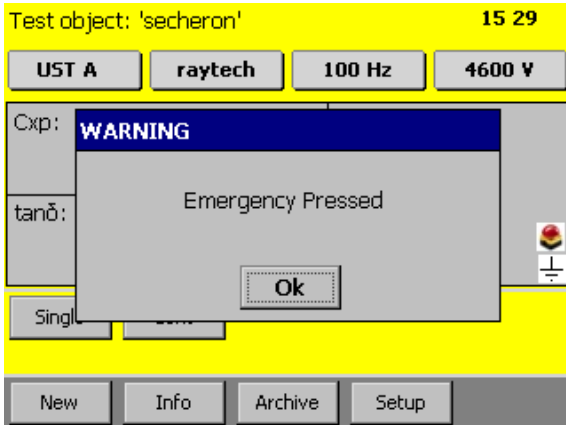

The emergency switch is activated.

In this condition it is not possible to start a measurement.

Exit this message screen by touching **OK** without releasing the emergency switch.

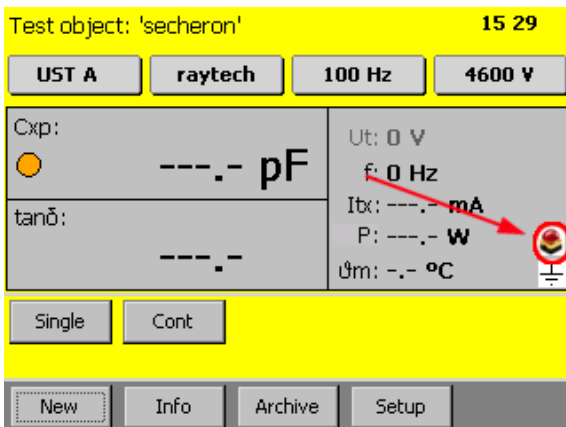

The system will revert to a pretest or main screen similar to the one shown:

Because the emergency switch is still pressed, you are not able to start a new measurement.

All other features of the system such as storing, printing are still active.



Turn the Emergency Stop button clockwise to release.

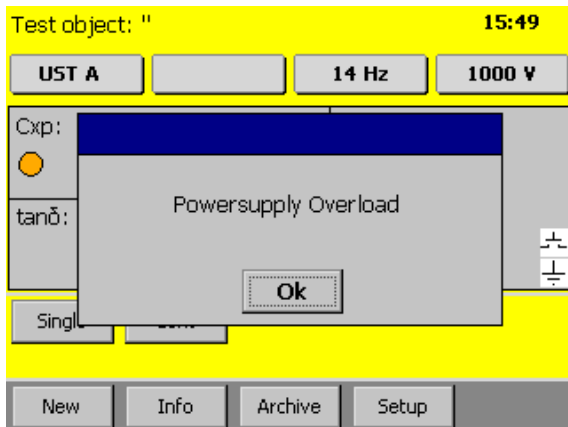

If the load is very big, e.g. that the measurement current is higher than 200mA, the CAPO protect itself, stops the measurement and shows the message "Powersupply Overload" or " Powersupply Undervoltage".

To measure the load, decrease the voltage or the frequency and try again.

## H Trouble Shooting

When the CAPO is powered on, an internal calibration and check sequence is performed.

Upon completion of the check sequence, the test set will proceed to the “Main Screen”.

If there any problem detected with the test set, an err or message will appear.

Test Voltage cannot be turned on

Press the safety-switch before starting the measurement.

If the contact is open, the safety-switch is not pressed.

The safety GND or the HV GND is not connected

The earth-symbol is crossed if an earth is missing.

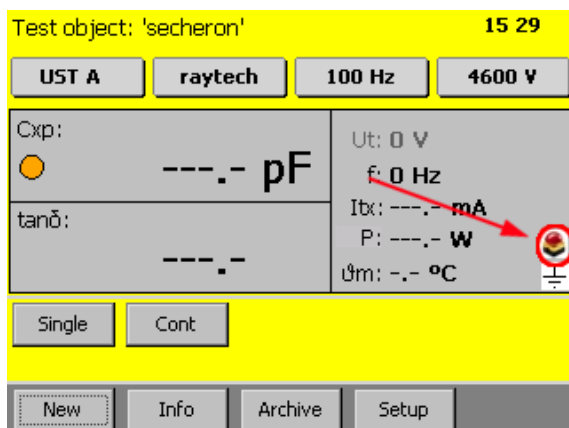
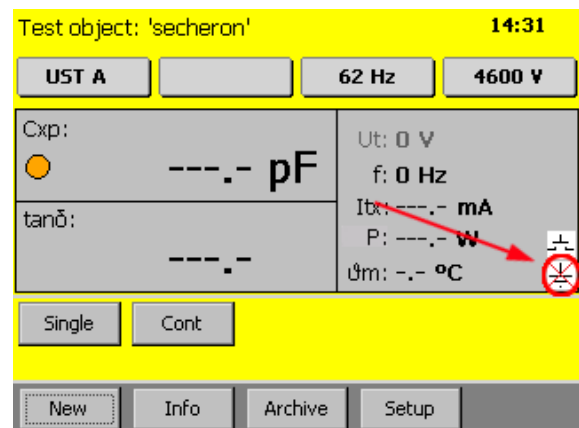
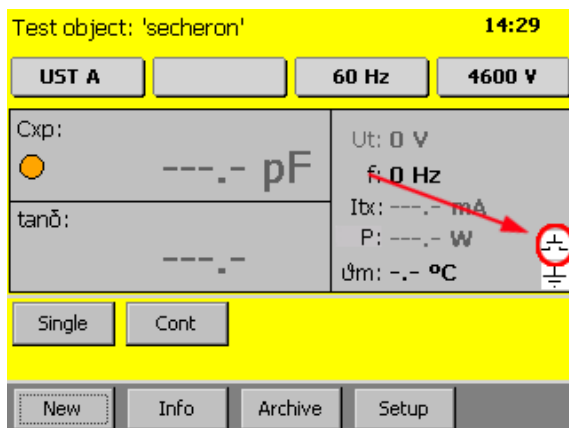

Is the Emergency stop switch pushed in? Turn it counter clockwise to release.

If the emergency button is pressed, there is a mushroom button visible.

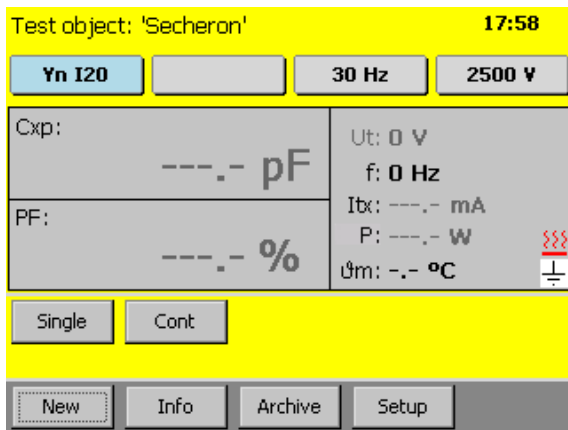

### Overheating:

If the CAPO is overheated (e.g. due to high current, high output voltage over a long period of time) the red symbol appears.

The CAPO protect itself, it stops the measurement and will not allowed to start a measurement till the temperature dropped to a normal value.

## H.1 Touch Panel does not work

Connect a USB mouse to the USB port and control the instrument with it. The instrument will automatically display a cursor and everything can be done by mouse. See chapter 8.2.7.1.4 Cursor on page 59.

Try to recalibrate the touch panel: See chapter F.1 Calibrate Touchscreen on page 104.

## H.2 USB Memory Stick does not work

There are a few unsupported memory sticks available on the market. Please use another model or brand and try again.<sup>1</sup>



### INFO:

The CAPO is designed to be trouble free. If problems or questions do arise, please contact your nearest representative or our service support group in Switzerland

<sup>1</sup> Depending on the type of formatting of the USB-stick, it can take up to 15 seconds until the stick is recognized. But this is really seldom.



## I Warranty Conditions

Raytech AG Switzerland shall at their option and expense, repair or replace any part or parts that prove to be defective within the warranty limitation period- irrespective of the operating time of the test equipment provided that the cause of the defect occurred prior to the time at which the risk was passed.

Warranty claims are subject to a warranty limitation period of 24 months from the date of shipment.

The purchaser is obligated to immediately notify Raytech AG Switzerland in writing of any defects of the supplied test equipment.

Raytech AG Switzerland must always be given the opportunity to rectify a defect within a reasonable amount of time. The purchaser shall grant an adequate amount of time that the test equipment shall be repaired.

Raytech AG Switzerland covers the costs associated with the repair of the defect; especially the costs for the material and work. Cost for sending the faulty test equipment shall be borne by the purchaser. Raytech AG Switzerland shall not be liable for material damage, or financial loss due to the loss of production, loss of data, loss of information, data or interest, regardless of their legal basis.

Warranty claim rights on replacement parts as well as repair of defective parts shall expire after 12 months.

Warranty limitation period shall be extendable according to the price list. The purchaser has the right to extend the warranty period by purchasing additional warranty years.

## **I.1 Limitation of Warranty**

The foregoing warranty shall not apply to defects resulting from:

- Improper and unauthorized modifications or misuse and abuse of the product, negligence, alteration, modification, faulty installation by the customer, customer's agents or employees.
- Attempted or actual dismantling, disassembling, service or repair by any person, firm, or corporation not specifically authorized in writing by Raytech AG Switzerland.
- Defects caused by or due to handling by carrier, or incurred during shipment, trans-shipment, or other move.
- Inadequate maintenance by the customer, second source supplied software or interfacing, operation outside the environmental limits, or improper site preparation.

Exclusive remedies provided herein are the customer's sole and exclusive remedies.

Raytech Switzerland shall not be liable for any damages resulting from the use of this equipment whether direct, indirect, special, incidental, or consequential damages, or whether based on contract, tort, or any other legal theory.

**INFO:**

NO OTHER WARRANTY IS EXPRESSED OR IMPLIED.

## I.2 Arbitration

All disputes arising out of or in connection with the contract between the purchaser and Raytech AG Switzerland and including those regarding the legal validity of this contract and this arbitration clause shall be settled out of court and shall be referred to arbitration for final decision.

Any disputes between the purchaser and Raytech AG Switzerland shall be settled according to the rules of settlement and arbitration of the chamber of commerce in Zurich by one or more arbitrators appointed also according to the rules of arbitration of the chamber of commerce in Zurich Switzerland.

## J Contacts

### Raytech Switzerland

Raytech AG  
Oberbenenstrasse 11  
5620 Bremgarten

Phone: +41 56 648 6010  
Fax: +41 56 648 6011

Mail: [welcome@raytech.ch](mailto:welcome@raytech.ch)  
Web: [www.raytech.ch](http://www.raytech.ch)

### Your Local Representative

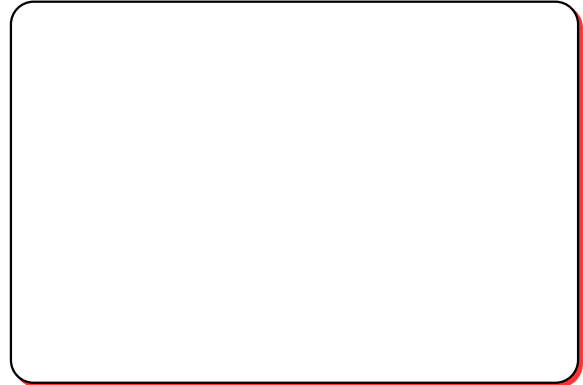
A large, empty rectangular box with rounded corners and a thin red border, intended for the user to enter the name and contact information of their local representative.

## K Index