



INSTRUCTION MANUAL

ENGLISH



mini-ATOS

mini Automatic Transformer
Observation System

RAYTECH AG, OBEBENESTRASSE 11, CH-5620 BREMGARTEN, SWITZERLAND

Preliminary

Contents

1	Safety Precautions.....	5
1.1	Operators Qualifications	5
1.2	High Voltage Apparatus Accessibility During the Tests	5
1.3	Ground the Instrument.....	5
1.4	Before Applying Power	6
1.5	Keep Away from Live Circuits	6
1.6	Do Not Operate in An Explosive Atmosphere	6
1.7	Do Not Substitute Parts or Modify Instrument	6
1.8	Do Not Operate in A Condensing Humidity or Under Rain	6
1.9	Always Keep Distance from the Test Object During the Tests	6
2	Unpacking.....	8
3	Introduction.....	9
4	Calculation and Measurement Methods.....	10
4.1	Turns Ratio Measurement.....	10
4.1.1	Principle.....	10
4.1.2	Voltage Ratio and Turns Ratio	10
4.1.3	Relative Error.....	12
4.2	DC Resistance Test.....	13
4.2.1	Principle.....	13
4.2.2	Temperature Correction.....	14
4.2.3	Resistance Deviation	15
4.3	Demagnetization.....	16
4.3.1	Raytech SPP Demagnetization Method	17
4.3.2	Three-Phase Transformer Demagnetization	18
4.4	Magnetic Balance	19
5	Measurement Setup.....	20
5.1	Connecting Test Cables to Transformer Terminals	20
6	Operation Elements	22
6.1	Mains Input, Fuse and Mains Switch.....	22
6.2	Ethernet Interface	22
6.3	USB Interfaces (1x Host, 2x Device).....	22
6.4	Safety Indicators	22
6.5	Protective Earth Terminal	23
6.6	Emergency Stop	23

6.7	Display and Touch Panel	23
6.8	Low Voltage Side Receptacles	23
6.9	High Voltage Side Receptacles.....	23
6.10	Thermal Printer	23
6.11	Tap Control.....	23
6.12	External	23
6.13	Current Clamp Receptacle.....	23
6.14	Temperature Channels Receptacles.....	23
7	User Interface	24
7.1	Home Screen.....	24
7.2	Archive	25
7.3	Templates.....	27
7.4	Settings.....	28
7.4.1	Date and Time	28
7.4.2	Regional	28
7.4.3	Naming Scheme	29
7.4.4	Networking.....	29
7.4.5	Remote Access.....	30
7.4.6	Maintenance	31
7.4.7	License	32
8	Test Objects.....	33
8.1	Power Transformer	33
8.1.1	Windings.....	34
8.1.2	Winding Configuration Autodetect.....	37
8.1.3	Nameplate	38
8.1.4	General.....	39
8.1.5	Tap Changer.....	41
8.1.6	Electrical Values	42
9	Inspection and Test Plan.....	46
10	Measurements	49
10.1	Turns Ratio	49
10.1.1	Table view modes.....	50
10.1.2	Turns ratio settings	52
10.1.3	Turns Ratio Results View.....	53
10.2	Winding Resistance	54
10.2.1	Dual Supply Winding Resistance	56
10.2.2	Winding Resistance Settings	57

10.2.3	Winding Resistance Result View	59
10.3	Winding Resistance Interval.....	60
10.3.1	Winding Resistance Interval Settings.....	62
10.3.2	Winding Resistance Interval Result View	64
10.4	Demagnetization.....	65
10.4.1	Demagnetization Settings	67
10.5	Magnetic Balance	68
10.5.1	Magnetic Balance Settings	70
10.5.2	Magnetic Balance Result View.....	71
11	Go Taps	72
12	Remote Access Instruction.....	74
13	Interfaces	76
13.1	USB.....	76
13.2	Ethernet.....	76
13.3	External (4pins version)	77
13.4	External (6pins version)	78
13.5	Tap Control.....	79
14	Technical Specifications.....	80
14.1	General.....	80
14.2	Accuracies	81
14.2.1	Turns Ratio Measurement	81
14.2.2	Resistance Measurements	82
14.2.3	Temperature Measurement.....	82
14.3	Standards and Approvals.....	83
A	Warranty Conditions	86
A.1	Limitation of Warranty	86
A.2	Arbitration	87
B	Maintenance	88
B.1	Instrument Cleaning Instruction	88
B.2	How to Insert Paper into Thermal Printer	88
B.3	Thermal Printer Cleaning instruction	89
C	Index.....	90
D	Contacts	92

1 Safety Precautions

The following safety precautions must be observed during all phases of operation, service and repair of this instrument. By purchasing this equipment, the purchaser assumes all liability for the operation and use of this equipment. The intended use of the instrument, its design and manufacture, is to be conducted within the precautions or other specific warnings located within this manual. Failure to comply with these precautions and other specific warnings violates the safety standards of design, manufacture, and intended use. Raytech assumes no liability for the operation and use of this equipment.

1.1 Operators Qualifications

Only qualified, knowledgeable persons should be permitted to or attempt to operate this test equipment. All testing personnel should fully familiarize themselves with the correct application and operation of this and all test equipment before operation.

The measurements should never perform by only one operator without the presence of other personnel or supervisors. Someone else other than the main operator must be aware and easily accessible to help in case of an emergency.

1.2 High Voltage Apparatus Accessibility During the Tests

Persons directly and indirectly engaged in the operation of this test equipment should keep clear of all high voltage apparatus while conducting tests and measurements. A barrier band must always use so the test object under the test is not accessible to any person during the test.



WARNING!

Never connect the instrument to an energized transformer!

1.3 Ground the Instrument

The power cord supplied with the equipment must be connected to an electrical receptacle with an electrically grounded terminal (earthed ground). To minimize shock hazards, the ground terminal on the instrument must be properly connected to the earth point. In many cases, the quality of the safety ground terminal provided by the power cord does not fulfil the safety requirements.



WARNING!

Non-grounded instruments are dangerous and may cause damage to personnel and to the instrument.

1.4 Before Applying Power

Read this manual carefully before operating the system. The instrument is line operated. The system is designed to be used with either 110VAC or 230VAC 50/60 Hz. The system performs a self-check each time that it is powered on.

1.5 Keep Away from Live Circuits

Operating personnel must not remove instrument covers. Component replacement and internal repairs must be made by qualified service personnel. Do not replace components or service this instrument with the power cable connected. To avoid injuries, always discharge circuits, disconnect power and remove external voltage sources before touching components.

1.6 Do Not Operate in An Explosive Atmosphere

Do not operate the instrument in the presence of flammable gases or fumes.

1.7 Do Not Substitute Parts or Modify Instrument

Because of the danger of introducing additional hazards, do not install substitute parts or perform any unauthorized modification to the instrument. Return the instrument to a Raytech service department for service to ensure proper operation and that safety features are maintained.

Instruments, which appear damaged or defective, should be made inoperative and secured against unintended operation until they can be repaired by qualified service personnel.

1.8 Do Not Operate in A Condensing Humidity or Under Rain

Operating the instrument in condensing humidity or under the rain can introduce an electric shock hazard for the user and also can damage the instrument. This instrument is not supposed to be installed permanently outdoor.

1.9 Always Keep Distance from the Test Object During the Tests

During performing the tests, there may be a hazardous voltage at the terminals of the test object. Always keep a distance of a minimum of 1.5m from the test object. The unsafe area must be specified and restricted with barrier tapes or ropes like Figure 1. Enter the area only when not testing and when the instrument shows that there is no output voltage which is specified when the green light indicator on the front panel is on.

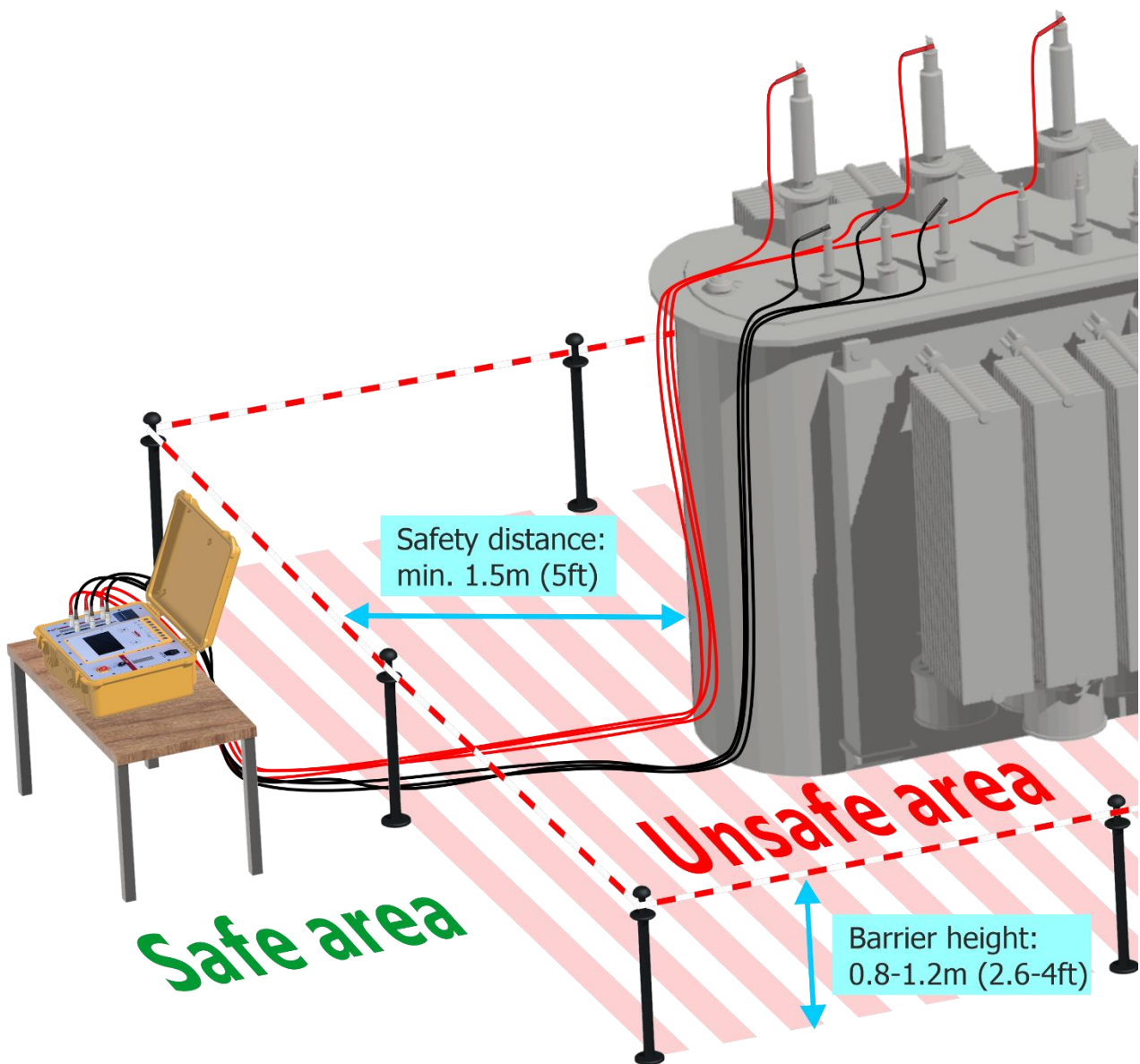

Figure 1: The unsafe area must be specified and restricted with barrier tapes or ropes



WARNING!

Always keep distance from the test object during the tests and the unsafe area must be specified and restricted with barrier tapes or ropes

2 Unpacking



The Instrument



Cable Bags



Measuring Cables H (H0-H3)



Measuring Cables X (X0-X3)



Safety Ground Cable



Power Cord



Spare Paper rolls & Fuses



USB Memory Stick



Instruction Manual (Pre.)

3 Introduction

The Raytech precision mini–Automatic Transformer Observation System (mini-ATOS) is a professional multifunctional power transformer and substation diagnosing test instrument developed by Raytech engineers. It is designed for a high degree of accuracy and ease of use.

This compact and intelligent instrument can perform many routines and advanced tests such as Winding Resistance (WR), Dynamic Resistance Measurement (DRM), Turns Ratio (TR), Frequency Response of Stray Losses (FRSL), Magnetic Balance, and other diagnostic parameters. With the built-in fully automatic multiplexer, only a one-time connection is required for nearly all functions which saves a considerable amount of time. The portable, rugged case is perfect for use anywhere onsite or in a laboratory. It is specially designed for fast and easy measurements with the well-known high precision and quality of all Raytech instruments.



INFO:

The mini-ATOS field case is a waterproof design (IP67). A pressure regulator activates when the case is opened to compensate for atmospheric pressure changes.

4 Calculation and Measurement Methods

4.1 Turns Ratio Measurement

4.1.1 Principle

The transformer turns ratio test is used for measuring the ratio of turns of wires of the two sets of windings e.g., the primary side and the secondary side of a transformer. The Turns Ratio test does not tell exactly how many turns of wire are in each coil, but rather, it measures and displays the ratio of the number of turns of two coils.

This is a useful test to check for shorted turns and also to find probable incorrect settings of tap changers during manufacturing or repairing.

The mini-ATOS performs the turns ratio by applying voltage on the high voltage side of each phase and measuring the applied voltage and transformed voltage. Figure 2 represents the very simple schematic of the measuring circuit.

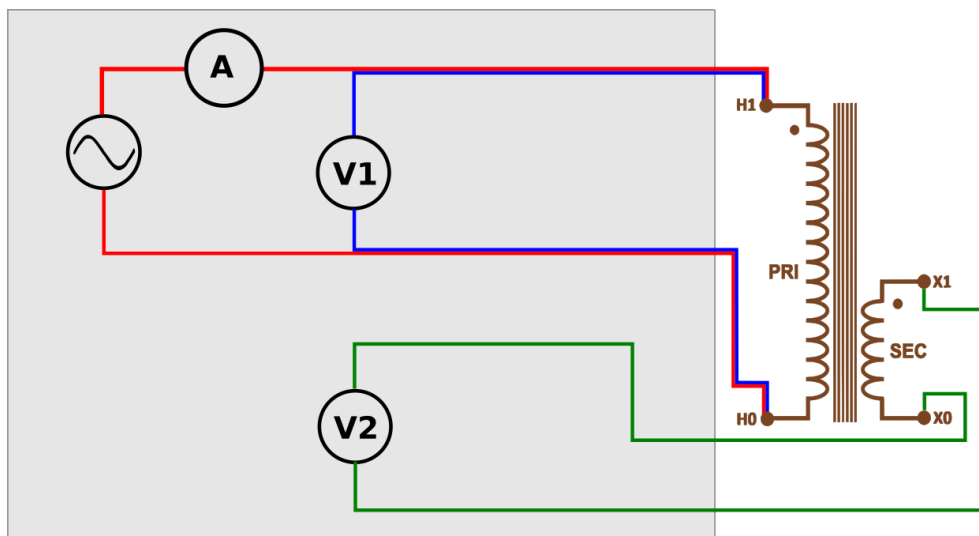

Figure 2: Very simple schematic of mini-ATOS turns ratio measuring circuit

The excitation current is also measured during the turns ratio test. The value of the excitation current has a direct relation to the test voltages. A higher test voltage leads to a higher excitation current. Additionally, the phase angle between the applied voltage and the transformed voltage is also measured and is included in the results.

4.1.2 Voltage Ratio and Turns Ratio

It is important to understand the differences between transformer voltage ratio and transformer turns ratio. The voltage ratio is the ratio of rated voltages of two windings but the turns ratio is exactly the ratio of the number of turns of two sets of windings. For a single-phase Transformer, the Turns Ratio is the same as the Voltage Ratio, however for a three-phase transformer they may be different.

As an example, consider a single-phase transformer schematic with a primary side and a secondary side. The primary side nominal voltage which is written on the nameplate is 6900V and from the manufacturing data, we know it consists of 15000 turns. And secondary side nominal

voltage written on the nameplate is 230V which consists of 500 turns from manufacturing data. The following equations are valid:

$$\text{Voltage Ratio} = \frac{\text{Rated Voltage Primary}}{\text{Rated Voltage Secondary}} = \frac{6900}{230} = 30$$

$$\text{Turns Ratio} = \frac{\text{Primary Number of Turns}}{\text{Secondary Number of turns}} = \frac{15000}{500} = 30$$

$$\text{Voltage Ratio} = \text{Turns Ratio} = 30$$

With three-phase transformers of different configurations, turns ratio and voltage ratio can be different.

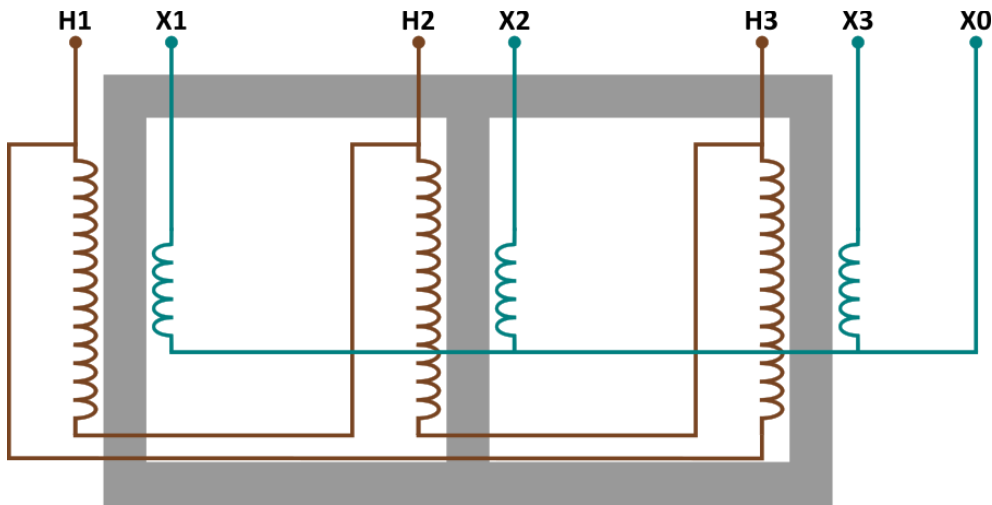

Figure 3: Three-phase transformer schematic with Dyn11 vector group

For example, Figure 3 shows a three-phase transformer schematic with a delta connection on the primary and Wye connection on the secondary side. 120000V and 20000V are written as primary and secondary rated voltages respectively on the nameplate. The rated values are always line-line voltages and the voltage ratio can simply calculate as follow:

$$\text{Voltage Ratio} = \frac{\text{Rated Voltage Primary}}{\text{Rated Voltage Secondary}} = \frac{120000}{20000} = 6$$

Turns ratio is different from the voltage ratio because the low voltage side connection is Wye and line-line rated voltage is different from the phase voltage. So, a factor of $\sqrt{3}$ is required as follow to calculated the nominal turns ratio:

$$\text{Turns Ratio} = \text{Voltage Ratio} \times \sqrt{3} = 6 \times \sqrt{3} = 10.3923$$

When we know the number of turns from the manufacturing data, the turns ratio can be calculated directly. Consider that for the current example the number of turns is 93531 and 9000 for each primary and secondary winding respectively. The following equations are valid:

$$\text{Turns Ratio} = \frac{\text{Primary Number of Turns}}{\text{Secondary Number of turns}} = \frac{93531}{9000} = 10.3923$$

$$\text{Voltage Ratio} = \frac{\text{Turns Ratio}}{\sqrt{3}} = \frac{10.3923}{\sqrt{3}} = 6$$

4.1.3 Relative Error

Turns ratio error can be calculated by comparison of the measured value and the reference rated value using the following formula:

$$\text{Err. [\%]} = \frac{|TR_{meas.} - TR_{rated}|}{TR_{rated}} \times 100\%$$

The calculated error can be compared with a limit value. Generally, there are limit values for the turns ratio relative error. A typical limit value according to IEEE C57.12.00-2010 is 0.5%. This limit value can be used to judge if the test is passed or failed.

4.2 DC Resistance Test

4.2.1 Principle

The winding DC resistance test is one of the most important tests. Many power transformer faults such as shorted turns, tap changer problems and loose connections can be detected.

Figure 4 represents the summarized winding resistance measurement circuit of the mini-ATOS. It utilizes the 4-wire measuring technique for each measurement. 2 wires to inject current and 2 wires to measure voltage. The test measuring cables and clamps are Kelvin type which means that the user does not have to hook up separately additional cables to the transformer for measuring.

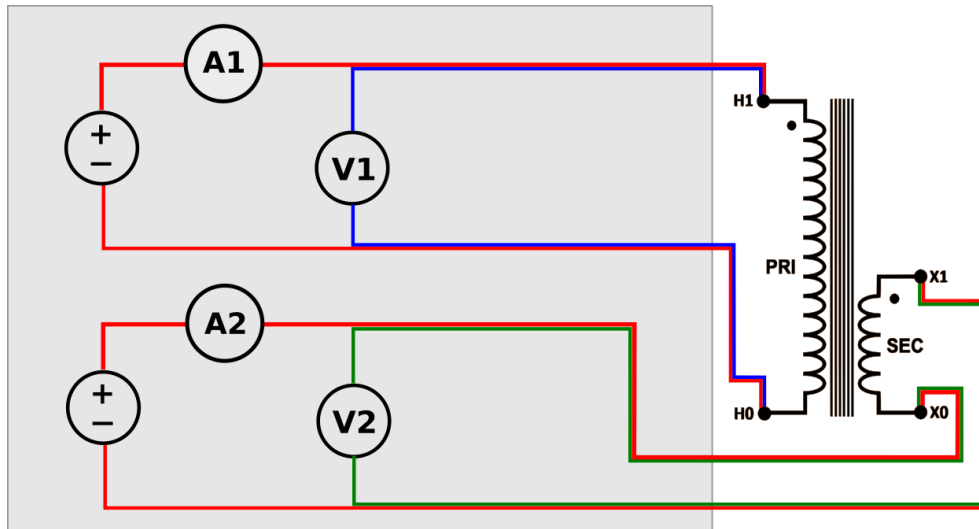

Figure 4: Summarized schematic of mini-ATOS winding resistance measuring circuit

The mini-ATOS has two power supplies with the same output power which can be used to measure both high voltage side and low voltage side winding simultaneously.

The maximum output voltage and current of each power supply are different to provide optimal output for each side. One power supply has more output voltage which is suitable for the high voltage side with a bigger resistance and the other one has more output current which is suitable for the low voltage side with a smaller resistance.

During the measurement, because of the high inductivity, the core and winding must be charged and only after charging, stable and accurate measuring is possible. The following equation represents the relation between the current injected into the winding, $I(t)$, and the voltage drop value, $U(t)$, across the winding. R is the winding resistance value that is aimed to be measured and L is the equivalent value of the inductivity.

$$U(t) = R \cdot I(t) + L \cdot \frac{dI(t)}{dt}$$

The voltage drop value consists of two parts; the first part is the voltage drop because of the resistance, and the second part is the voltage drop because of the inductivity. After charging, the second part tends to zero and then the Resistance value can be calculated:

$$\frac{dI(t)}{dt} \rightarrow 0 \Rightarrow U(t) = R \cdot I(t) \Rightarrow R = \frac{U}{I}$$

The mini-ATOS winding resistance circuit is also equipped with heavy-duty discharge circuits that are very unique in design to dissipate the stored energy in the transformer windings.

4.2.2 Temperature Correction

The DC resistance measured values can be corrected to the desired reference values by employing the following equation based on IEEE C57.12.90:

$$R_s = R_m \frac{T_s + T_k}{T_m + T_k}$$

Where:

$R_s[\Omega]$ = Corrected Resistance

$R_m[\Omega]$ = Measured Resistance

$T_s[^\circ\text{C}]$ = Desired Reference Temperature

$T_m[^\circ\text{C}]$ = Actual Temperature at the time of Resistance Measurement

$T_k[^\circ\text{C}]$ = Correction Temperature

Correction values for copper and aluminum are:

Table 1: Cu and Alu temperature correction values

Material	$T_k[^\circ\text{C}]$
Copper	234.5
Aluminum	225
Alloyed aluminum	Can be up to 230

The other form of temperature correction formula is:

$$R_m = R_s(1 + \alpha(T_m - T_s))$$

Where:

α = Coefficient Factor of Resistivity at Desired Reference Temperature

T_k and α have the following relationship:

$$T_k = \frac{1}{\alpha} - T_s = \frac{1}{\alpha(@20^\circ\text{C})} - 20$$

For example, by considering that the value of α for copper is 0.00393 at 20°C, T_k is:

$$T_k = \frac{1}{0.00393(@20^\circ\text{C})} - 20 \cong 234.5$$

4.2.3 Resistance Deviation

For a 3-phase test object, the DC resistance values of each phase are supposed to be almost the same. Hence, it is possible to measure a deviation value from the average value for each phase as follows:

$$R_{avg}[\Omega] = \frac{R_A + R_B + R_C}{3}$$
$$R_{dev,A}[\%] = \frac{R_A - R_{avg}}{R_{avg}} \times 100$$
$$R_{dev,B}[\%] = \frac{R_B - R_{avg}}{R_{avg}} \times 100$$
$$R_{dev,C}[\%] = \frac{R_C - R_{avg}}{R_{avg}} \times 100$$

The calculated deviations can be compared to a maximum deviation limit value to find out if the result is passed or failed. There is a limit in IEEE C57.12.152-2013, which is 2%. However other values are also possible with agreements.

Please note that if the temperature of phases is not the same during the resistance measurements, the deviation values may be higher. In this case, it is better to calculate the deviation values of the temperature-corrected resistances.

4.3 Demagnetization

After winding resistance measurement or transformer shutdown, there is always residual magnetism or remanence in the transformer magnetic core. There are various reasons that this remanence should be removed. One reason is that energizing a transformer with remanence can cause a much higher inrush current and hence probable deformation of the winding. The other reason is that the remanence will affect the results of some tests such as SFRA, magnetic balance and excitation current, which may lead to a wrong diagnosis.

The mini-ATOS includes a very efficient, fast and modern demagnetization feature. During the demagnetization, all important parameters are measured, calculated and monitored continuously and each cycle of the demagnetizing is adjusted and performed according to the previous cycles.

Figure 5-A shows an actual example of a hysteresis curve during demagnetization which is performed using the mini-ATOS. Figure 5-B is a closer look at the same curve. The depicted parameters are described below:

- $\Phi[V.s]$: Magnetic flux with the unit of Volt-seconds or Weber. It will be measured as integral of the inductive part voltage over time. The value of the Vs is related directly to the Magnetic flux density with the unit of Tesla, by considering that the cross-section area of the transformer magnetic core is a constant value:

$$T = \frac{V.s}{m^2} ; m^2 = constant \Rightarrow T \propto V.s$$

- $H(\frac{At}{m})$: Magnetic field strength with the unit of Ampere. Turn/meter. The number of the turns and length of the magnetic path is usually unknown but since they are constant values, the magnetic field strength is in direct relation to the injected current to the winding which can be measured directly:

$$\frac{At}{m} ; t = constant , m = constant \Rightarrow \frac{At}{m} \propto A$$

- $\pm\Phi_{sat}$: Maximum positive or negative flux at saturation point
- Φ_{init} : The initial value of the residual magnetism flux or remanence flux before demagnetization
- Φ_{final} : The final value of the remanence flux after performing the demagnetization
- $\pm\Phi_{rem}$: Maximum positive or negative remanence flux remains in the magnetic core which is normally happened after saturation.

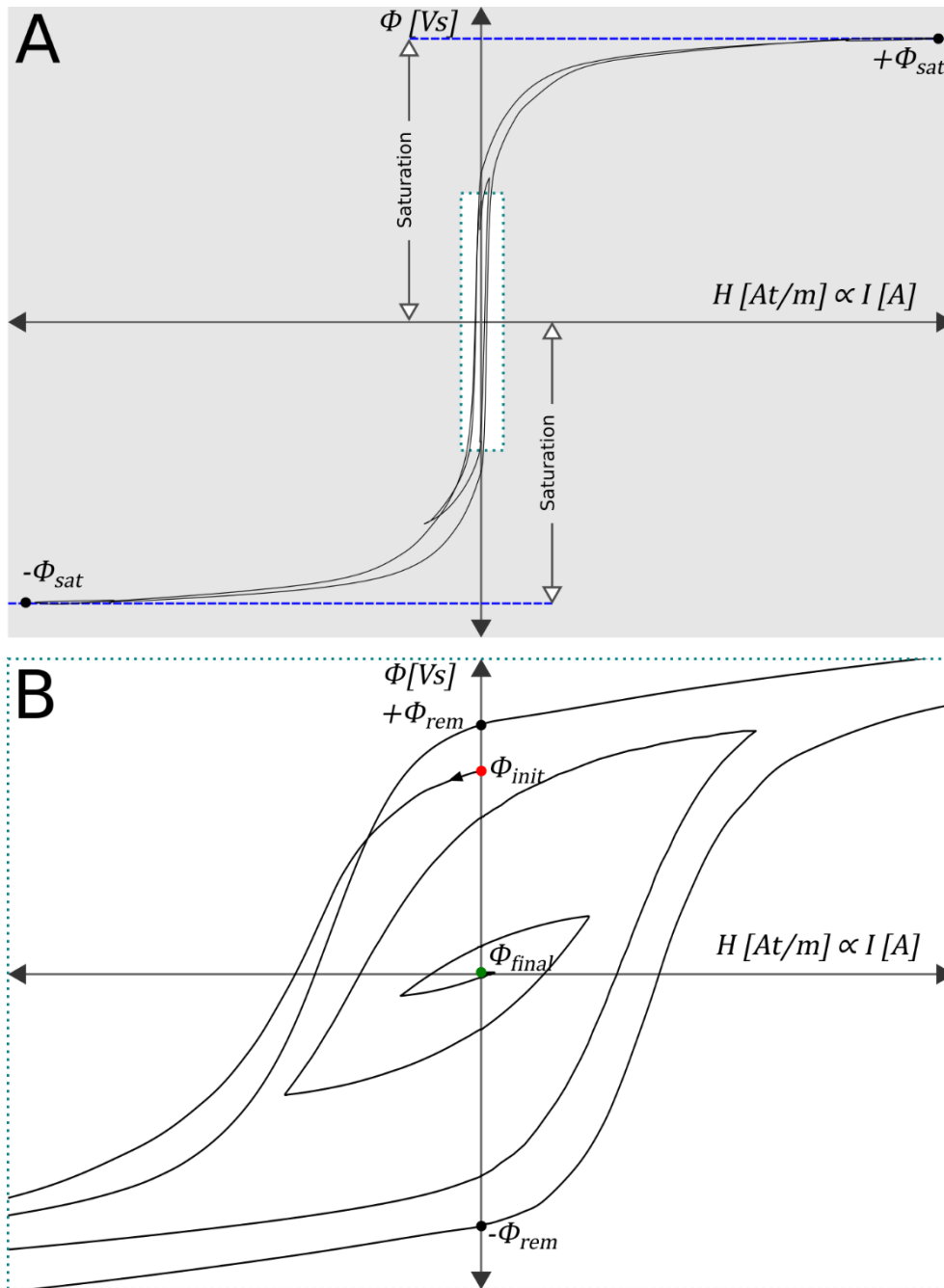

Figure 5: A) A real example of a hysteresis curve during demagnetization with the mini-ATOS. B) Closer look at the same curve in A.

4.3.1 Raytech SPP Demagnetization Method

To achieve a very small residual magnetism, the mini-ATOS use a special method to perform the final cycles of the demagnetization, called **SPP**, **Smart Pattern Predictor**, which is based on pattern recognition. This is very useful when special measurements like SFRA are desired to perform.

This method recognizes the properties and shape of the demagnetization of previous cycles to achieve a very small remanence, the shape and properties of the final cycles are predicted and then the final cycles will be performed in a way to achieve the best and the smallest possible residual magnetism state.

4.3.2 Three-Phase Transformer Demagnetization

For a core-type three-phase transformer with three limbs, the demagnetization is usually performed from the middle phase. Many times, it is enough to achieve a safe residual magnetism state to connect the transformer to the power grid without the risk of high inrush current. However, it is not always like this. Sometimes the demagnetization should be performed from all three phases. The following items can be a reason to consider a three-phase demagnetization:

- When the core consists of 4 limbs or 5 limbs
- When the transformer is a shell-type
- When the aim is to achieve a very small residual magnetism to perform special tests like SFRA

The mini-ATOS can use the advantage of the automatic multiplexer to perform demagnetization from each phase automatically and without changing the connection setup.

4.4 Magnetic Balance

Raytech mini-ATOS performs the magnetic balance test by applying AC voltage on each winding of the three-phase transformer from the high voltage side and measuring induced voltage into other windings on the same side. The applied voltage produces magnetic flux in the core which is distributed to other parts of the core and induces a voltage into other windings. Any problem or fault in the magnetic core may change the distribution of flux.

For a healthy core-type transformer with a demagnetized 3 limb core, the magnetic balance test results should be in the form of Table 2:

Table 2: Typical magnetic balance pattern of a core-type transformer with 3 limbs

Phase	→ A	→ B	→ C
A	$V_{A \rightarrow A} = 100\%$	$V_{A \rightarrow B} \cong M\%$	$V_{A \rightarrow C} = N\%$
B	$V_{B \rightarrow A} \cong 50\%$	$V_{B \rightarrow B} = 100\%$	$V_{B \rightarrow C} \cong 50\%$
C	$V_{C \rightarrow A} \cong N\%$	$V_{C \rightarrow B} \cong M\%$	$V_{C \rightarrow C} = 100\%$

The sum of M and N should be almost 100% and it is supposed to M be greater than N :

$$M + N \cong 100, \quad M > N$$

The index TCI [%], Transformer Core Imbalance, introduced by Raytech for easy diagnosing of magnetic balance test results. It is calculated using the following formula:

$$\text{Core Imbalance [\%]} = 100 \times \left(\frac{|V_{A \rightarrow C} - V_{C \rightarrow A}|}{V_{A \rightarrow C} + V_{C \rightarrow A}} + \frac{|V_{B \rightarrow A} - V_{B \rightarrow C}|}{V_{B \rightarrow A} + V_{B \rightarrow C}} + \frac{|V_{A \rightarrow B} - V_{C \rightarrow B}|}{V_{A \rightarrow B} + V_{C \rightarrow B}} \right) \times \frac{1}{3}$$

Please note that when the core is not fully demagnetized, the TCI value may be high. For a correct magnetic balance test, it is highly recommended to always demagnetize the core beforehand. On the other hand, by performing the magnetic balance test, it is possible to find out if the transformer core is demagnetized or not.

5 Measurement Setup

5.1 Connecting Test Cables to Transformer Terminals

This part explains the setup measurement for almost all possible measurements of a power transformer.

Connect the mini-ATOS to the transformer under test with the labelled test leads using the connection guide in Table 3 and Table 4.

When you want to perform a measurement in which tertiary winding is involved (e.g., Turns ratio between primary and tertiary), you have to connect the mini-ATOS X Cables to the tertiary side.

Because of safety, take care when you perform tests between secondary and tertiary. The voltage may transform to a very dangerous level at the primary side during the measurements. Always keep distance and never touch the test object.

Check the nameplate information of the transformer. If the nameplate is missing it is still possible to test the transformer by a trial-and-error method. The mini-ATOS test set is designed to detect errors in transformer hook-ups. Contact Raytech Service & Support department if you need assistance.



WARNING!

Take care when you test between secondary and tertiary! The voltage may transform to a very dangerous level at the primary side during the measurements. Always keep distance and never touch the test object!

Table 3: Test cables connection guide for a Single (1) phase transformer or auto-transformer

Voltage Level	mini-ATOS Test Cable Label	Transformer Marking Standard			
		IEEE	IEC	BS	
Primary	H1	H1	1.1 ¹	U1	A1
	H2	H2	1.2	U2	A2
Secondary	X1	X1	2.1	u1	a1
	X2	X2	2.2	u2	a2
Tertiary	X1	Y1	3.1	3U1	3A1
	X2	Y2	3.2	3U2	3A2

¹ Dot can be a letter. For example: 1U1

Table 4: Test cables connection guide for a three (3) phase transformer

Voltage Level	mini-ATOS Test Cable Label	Transformer Marking Standard			
		IEEE	IEC	BS	
Primary	H1	H1	1U	U	A
	H2	H2	1V	V	B
	H3	H3	1W	W	C
	H0	H0	1N	N	N
Secondary	X1	X1	2U	u	a
	X2	X2	2V	v	b
	X3	X3	2W	w	c
	X0	X0	2N	n	n
Tertiary	X1	Y1	3U	3U	3A
	X2	Y2	3V	3V	3B
	X3	Y3	3W	3W	3C
	X0	Y0	3N	3N	3N

6 Operation Elements

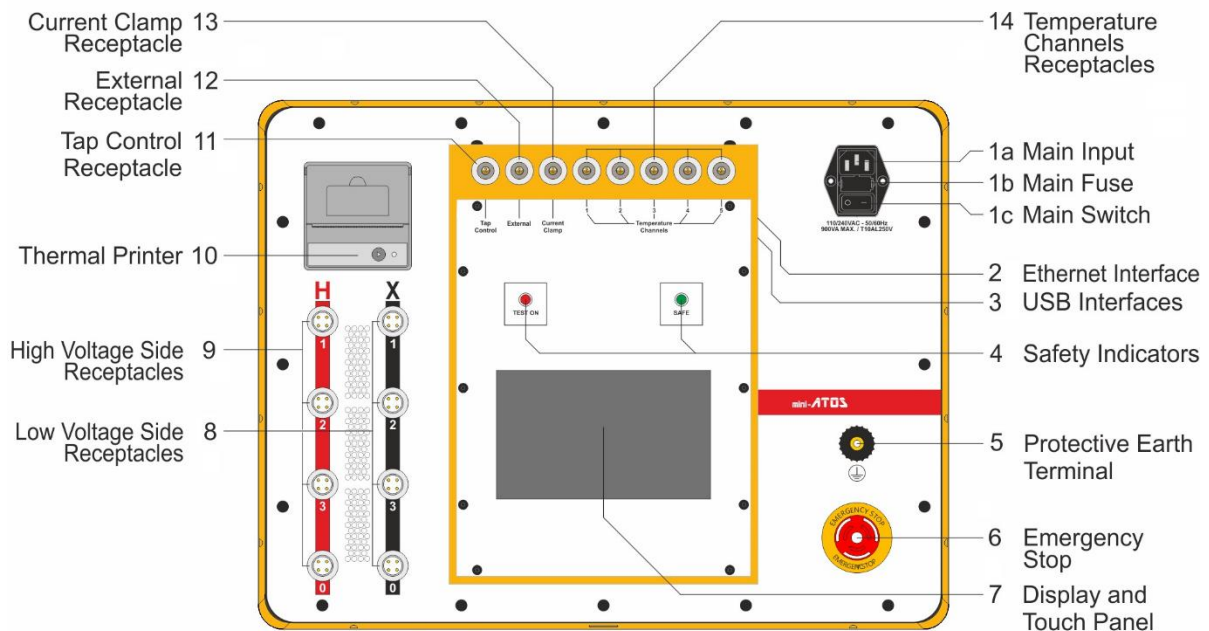

6.1 Mains Input, Fuse and Mains Switch

- a- Connect the power cable to the Mains Input. Use only a standard C13 type connector. The cable must be rated at least 10A.
- b- Two 5mm x 20mm T10A slow blow fuses protects the device. Use only the same type for replacement.
- c- Press the Mains Switch to turn the mini-ATOS ON/OFF.

6.2 Ethernet Interface

This port can be used for remote access. Please see chapter 11 for more information about the remote connection.

6.3 USB Interfaces (1x Host, 2x Device)

1x USB Host, 2x USB Device

6.4 Safety Indicators

Green Light ON: The system is in safe mode. Ready for handling test leads and connections.

Red Light ON: Unsafe mode! Don't remove any cables, the current is flowing and there is a hazardous voltage on the test leads!



WARNING!

The transformer is not discharged!

6.5 Protective Earth Terminal

Use this terminal to connect a protective earth line.

6.6 Emergency Stop

Press to Stop. The measurement will cease and halt Voltage to the test leads immediately.
Turn clockwise to release. The device will remain in a safe state.

6.7 Display and Touch Panel

The mini-ATOS can be easily controlled by this touch screen panel. Since it is a capacitive touch screen, use your finger to control it as you work with a smartphone.

If preferred, an external mouse and keyboard can be connected to the USB Port.

6.8 Low Voltage Side Receptacles

To connect the instrument to the low voltage side terminals of a test object.

6.9 High Voltage Side Receptacles

To connect the instrument to the high voltage side terminals of a test object.

6.10 Thermal Printer

Allows you to quickly get your results on paper by using the built-in thermal printer.

6.11 Tap Control

This port is used for an external connection to a tap changer dry contact. With this connection, the tap position can be changed from the mini-ATOS.

6.12 External

This port is multi-functional and consists of the following functions:

- connecting an external warning device like a warning lamp.
- connecting a tap changing hand switch.
- connecting an external safety interlock like a safety door or a safety hand switch (Only 6pin version).

6.13 Current Clamp Receptacle

This port can be used for connecting an optional current clamp. This current clamp is used for additional measuring features such as DRM motor current.

6.14 Temperature Channels Receptacles

These 5 receptacles are for connecting the external temperature probes.

7 User Interface

7.1 Home Screen

On the home screen, easy access to the main parts of the operation menu is provided. Figure 6 represents the mini-ATOS home screen.

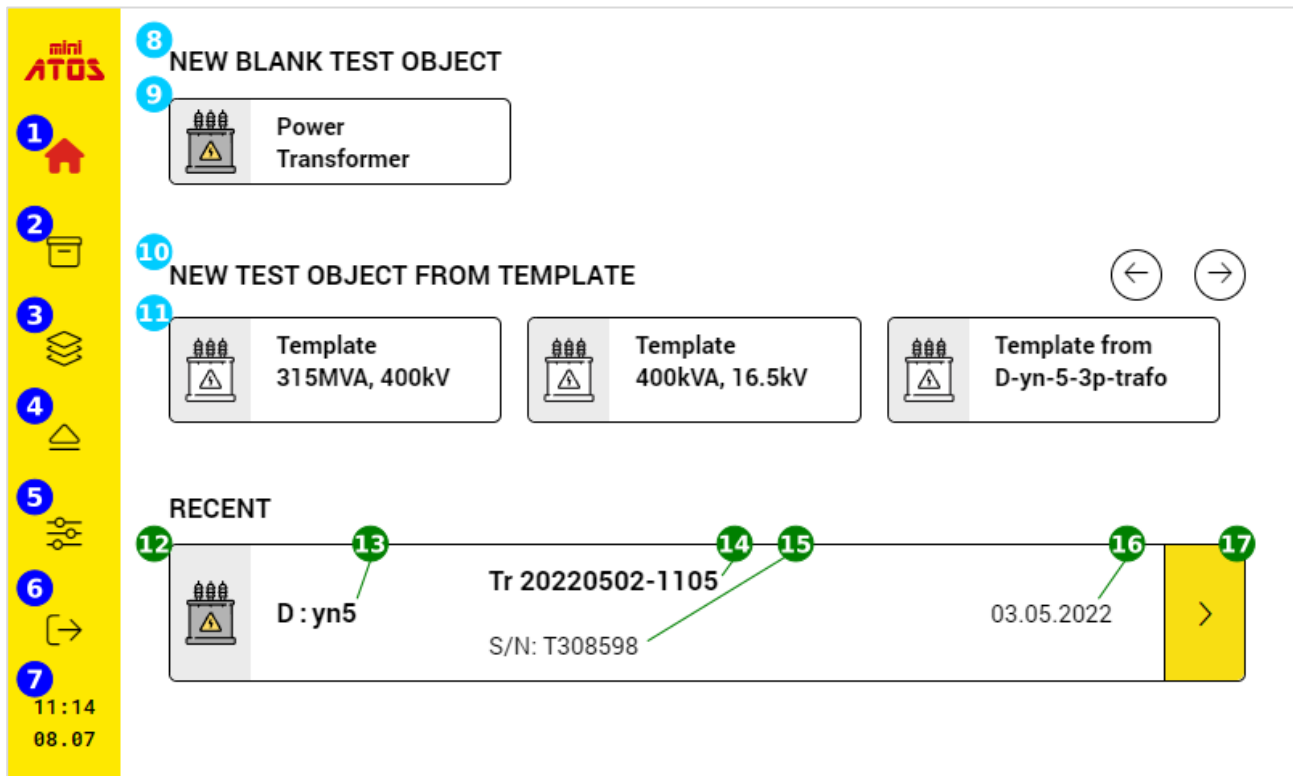

Figure 6: The mini-ATOS home screen

1	By tapping the Home icon from any page, you will jump to the Home Screen	8	List of test object types to define a new blank one
2	Archive button, which is used to access all previously defined test objects. Please see chapter 7.2 for more details	9	To define a new power transformer test object. Please see chapter 8.1 for more details
3	Access all test object templates and manage them. Please see chapter 7.3 for more details	10	List of favorite templates, to define a test object from a template. See chapter 07.3 to find out how to define a template
4	To remove safely the USB stick	11	A test object template item
5	Settings button to access the device settings. Please see chapter 07.4 for more details	12	Most recent active profile
6	By tapping this button, you will log out and it is possible to activate the remote connection. For more details about the remote connection, please see chapter 11	13	Connection and vector group
7	Date and time	14	Test object name
		15	Test object serial number
		16	Last measuring date
		17	Jump to the last active measurement window

7.2 Archive

In Archive, a list of already defined test objects is shown (Figure 7).

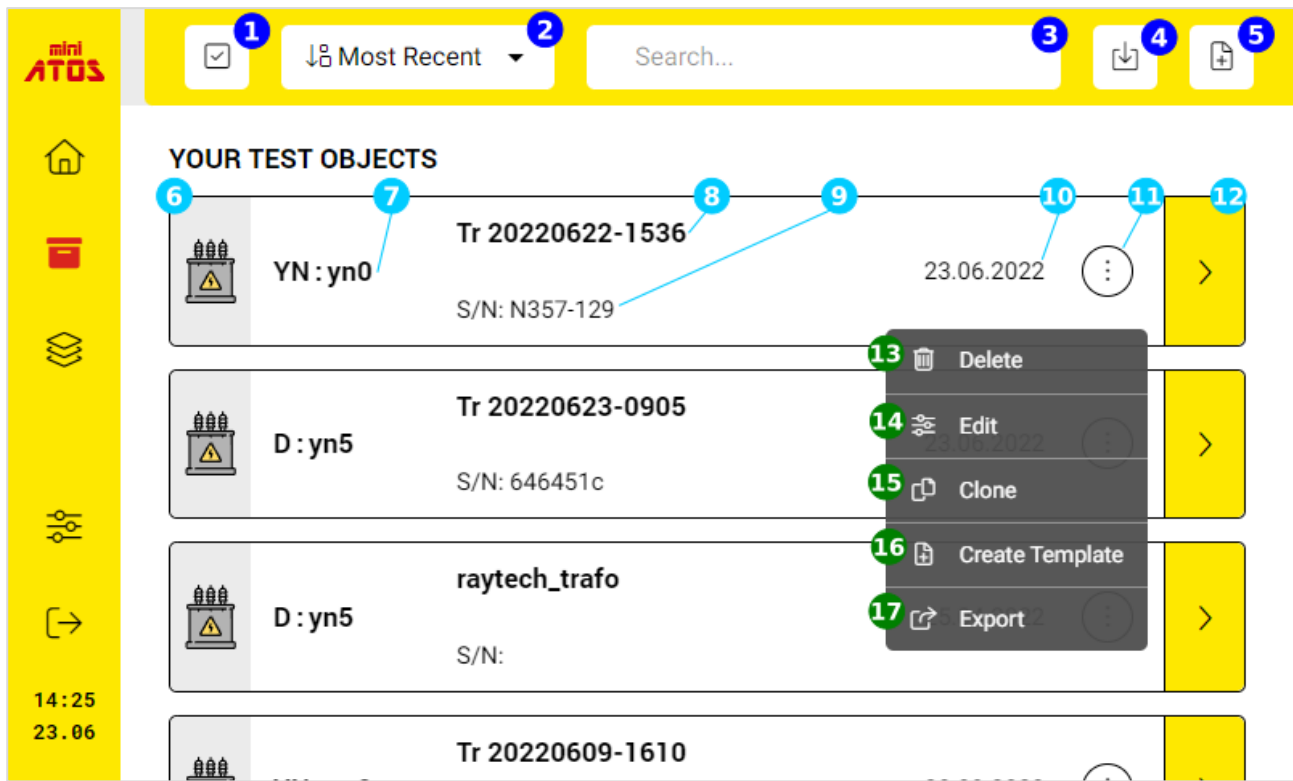

Figure 7: The mini-ATOS test objects Archive

1	To activate the multi-select to export or delete test objects	10	Last activity date
2	Sort the test object records based on various fields	11	To open the option menu
3	Search tool to find a test object from the list. The search word can be the name, serial number or winding connection type	12	Open the test object
4	To import a test object from the connected USB stick	13	To delete the test object
5	To create a new test object	14	To edit the test object
6	Test object record	15	To clone the test object
7	The test object winding configuration	16	To create a template from the test object (See chapter 07.3 for more information)
8	Test object name	17	To export the test object to a USB stick
9	Test object serial number		

By opening each test object, the history of the inspections and test plan measurements will be displayed as in Figure 8.

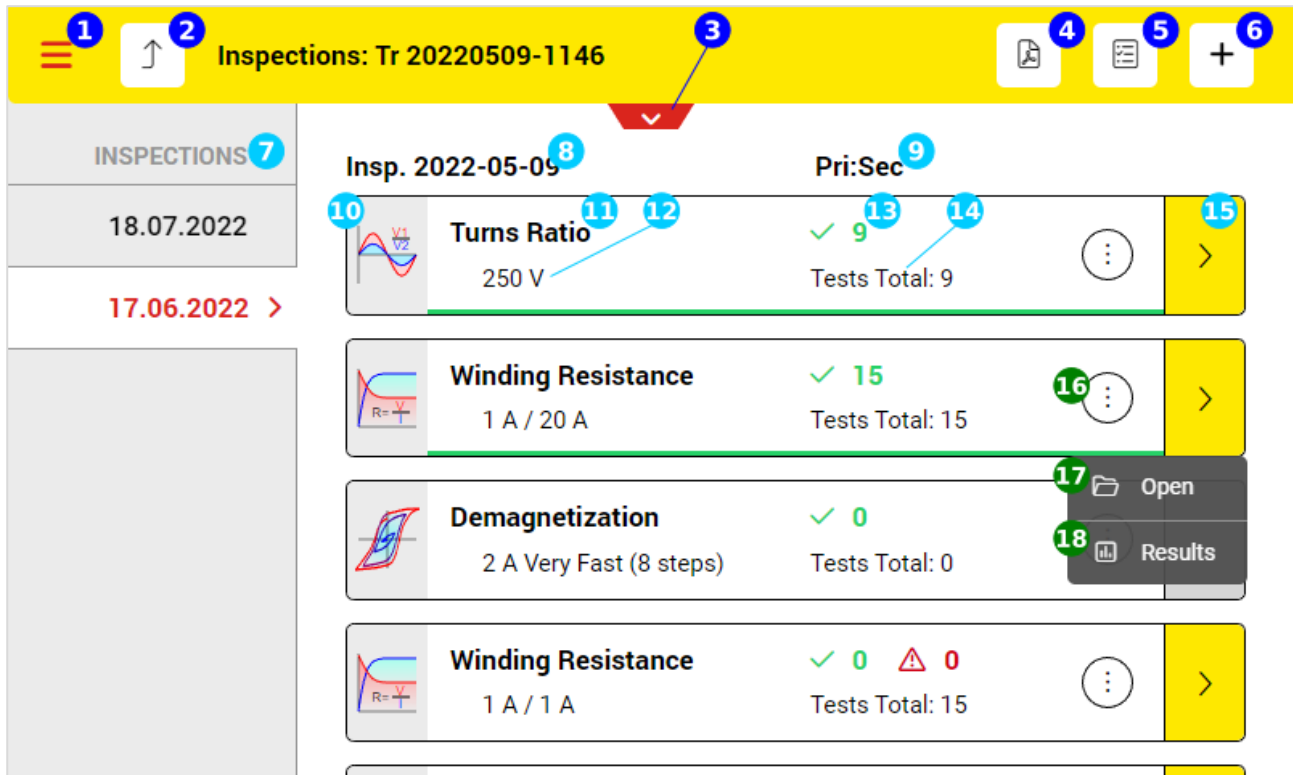



Figure 8: List of measurements for each test object in Archive

1	To open the main menu	10	The test plan measurement item
2	To go back to the Archive	11	The measurement type
3	Open test object quick access	12	The measurement setting
4	To generate and export the PDF report	13	The number of measurements which were performed and the result was passed
5	To jump to the test plan page and perform the measurements	14	The total tests possible for the measurement
6	To add a new inspection	15	To open the result view in graph and table
7	The list of inspections sorted by date	16	To open the option menu
8	The selected inspection title	17	To open the measurement view
9	The selected test plan measurement sides	18	To open the result view in graph and table

7.3 Templates

When there are some test objects with the same specifications, it is good to make a template for all of them. Later it is possible to use the template to define each test object easier and faster by avoiding entering the same information each time.

Figure 9 shows the template list. To create a new template, just tap the add button  and input the template data the same as to create a new test object (See chapter 8). You can then save it and jump to the test plan page. Test plan is also a part of the template. It is possible to adjust the test plan including the measurement settings.

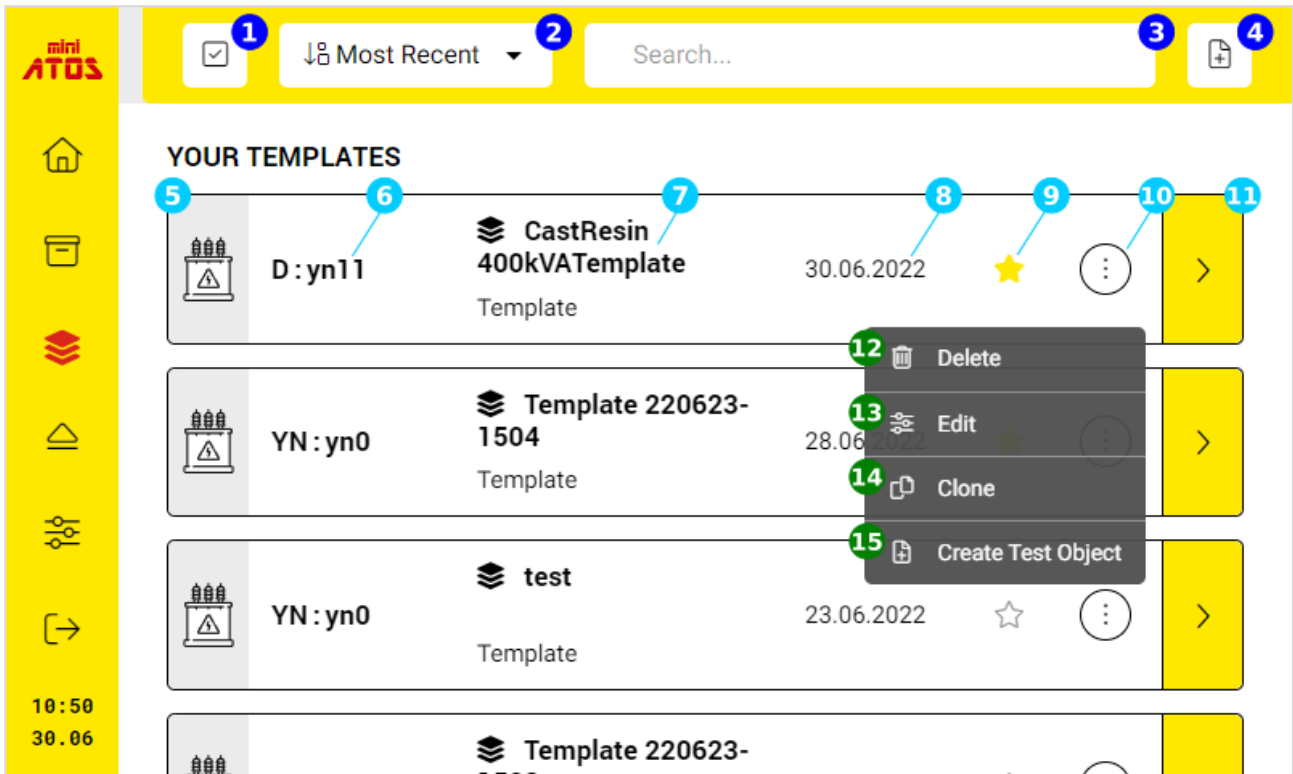

Figure 9: Test object templates

- | | | | |
|----------|--------------------------------------------------------------------------------------------------------------|-----------|--------------------------------------------------------|
| 1 | To activate the multi-select to delete more templates together | 9 | When it is marked, it will be shown on the home screen |
| 2 | Sort the template items based on various fields | 10 | To open the option menu |
| 3 | Search tool to find a template from the list. The search word can be the name or the winding connection type | 11 | To open the template and edit the template test plan |
| 4 | To create a new template | 12 | To delete the template |
| 5 | Template item | 13 | To edit the template |
| 6 | The template winding configuration | 14 | To clone or make a copy from the template |
| 7 | Template name | 15 | To create a test object from the template |
| 8 | Date created | | |

7.4 Settings

7.4.1 Date and Time

In this tab, Date and Time and related settings like Country and Time zone can be adjusted. Simply you can tap each field and change its values.

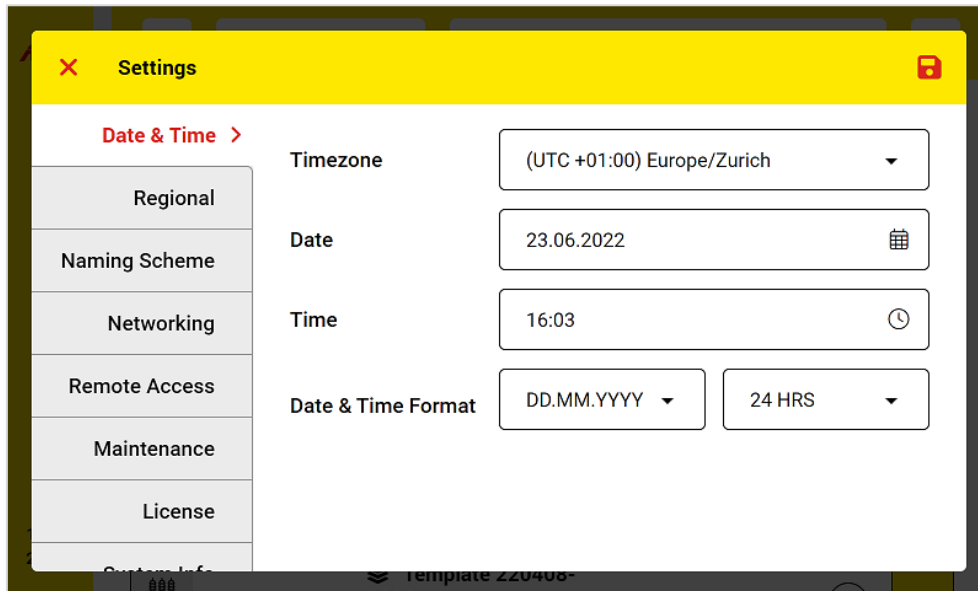

Figure 10: Date and time adjustment in Setting

7.4.2 Regional

The user interface language, default temperature unit format, numbers decimal separator and CSV separator can be selected in the Regional tab (Figure 11).

CSV separator is helpful for software like excel to correctly show results as data columns from the exported results in CSV format. Depending on the PC language, sometimes comma [,] is the separator and sometimes semicolon [;] is the separator.

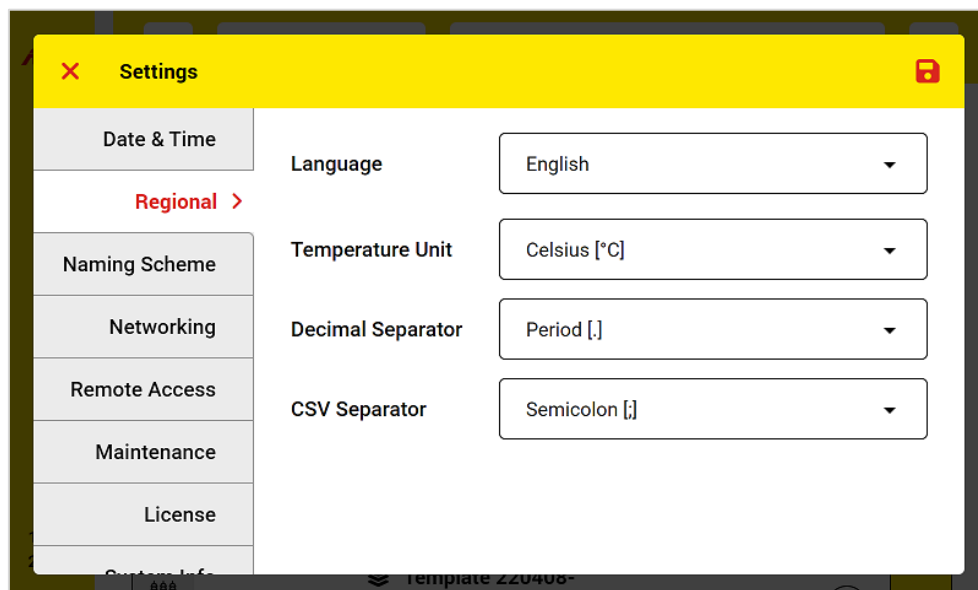

Figure 11: Regional adjustments in Setting

7.4.3 Naming Scheme

In the Naming Scheme tab (Figure 12), it is possible to set the default naming scheme of a new test object. Generally, there are different systems of terminal naming for each test object. There is also a custom naming scheme which can be easily edited to use it later.

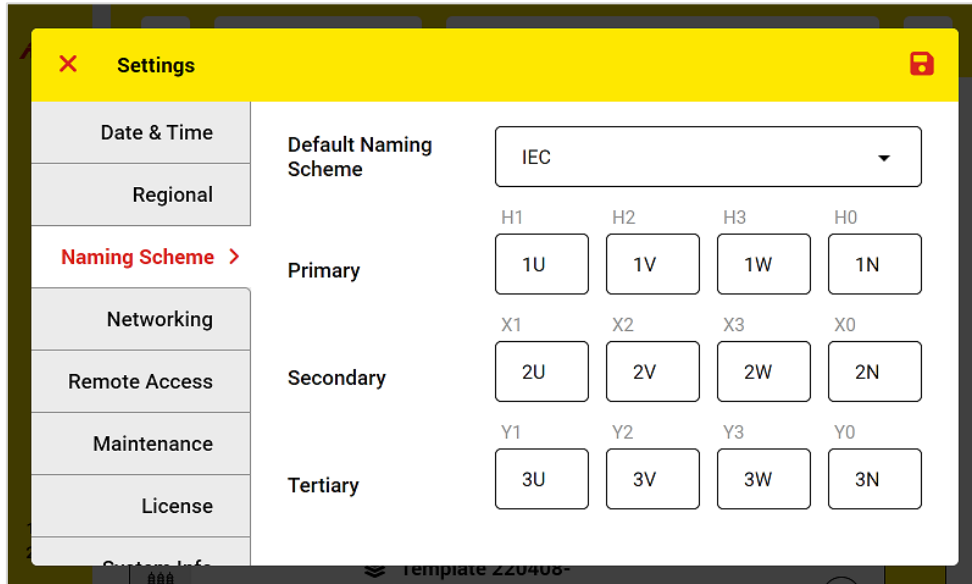

Figure 12: Default Naming Scheme adjustment

7.4.4 Networking

In this tab (Figure 13), you can adjust the networking settings which are required for remote access. For more information about remote access please see chapter 11.

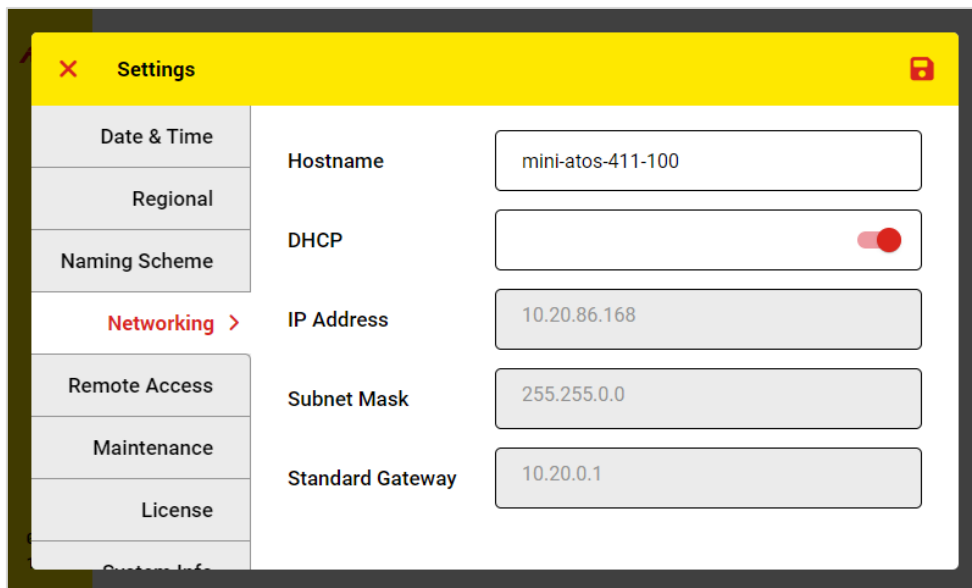

Figure 13: Network configuration

Hostname

The system usually assigns the Hostname automatically according to the device serial number. It is also possible to change this name. This name will be used as the address (`http://"Hostname"`) to access the device remotely via Ethernet connection. Please see chapter 11 for more information.

DHCP

When DHCP (Dynamic Host Configuration Protocol) is activated, the system configures the network automatically and the user doesn't need to do it manually.

IP Address, Subnet Mask, Standard Gateway

Here you can configure the network manually by entering the required fields.

7.4.5 Remote Access

Here there are remote access settings which are required to be adjusted (Figure 14). To see the remote access guide, please see chapter 11.

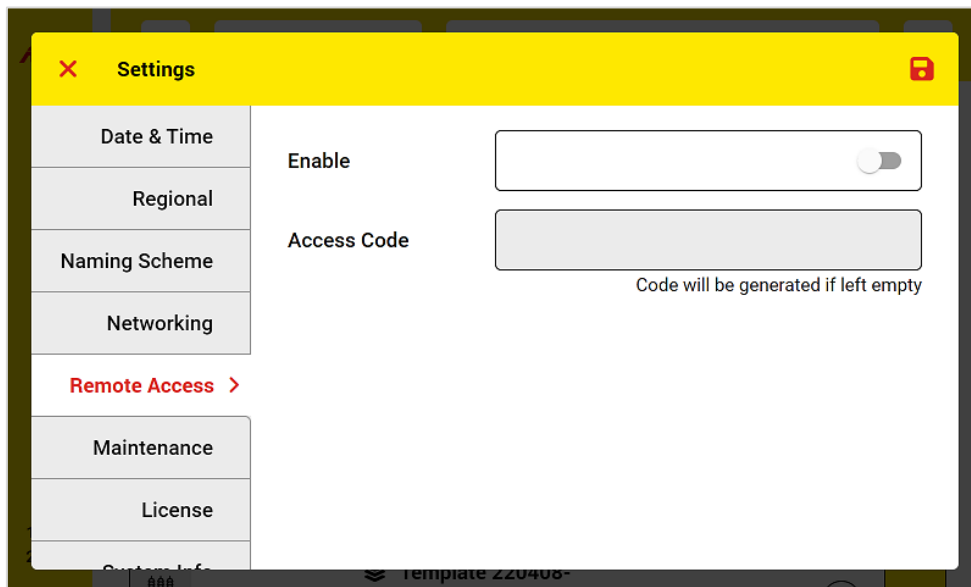

Figure 14: Remote Access settings

Enable

Use this toggle button to enable or disable remote access.

Access Code

Because of security, an access code is always required to log in to the software. The access code can be set manually by entering the intended number (6 digits) or the code will be generated automatically (4 digits) if the field is left empty. The generated code will be shown on the login page on the device screen. To find out how to control the device with remote access, please see chapter 11.

7.4.6 Maintenance

Figure 15 shows the maintenance tools and each one is explained below.

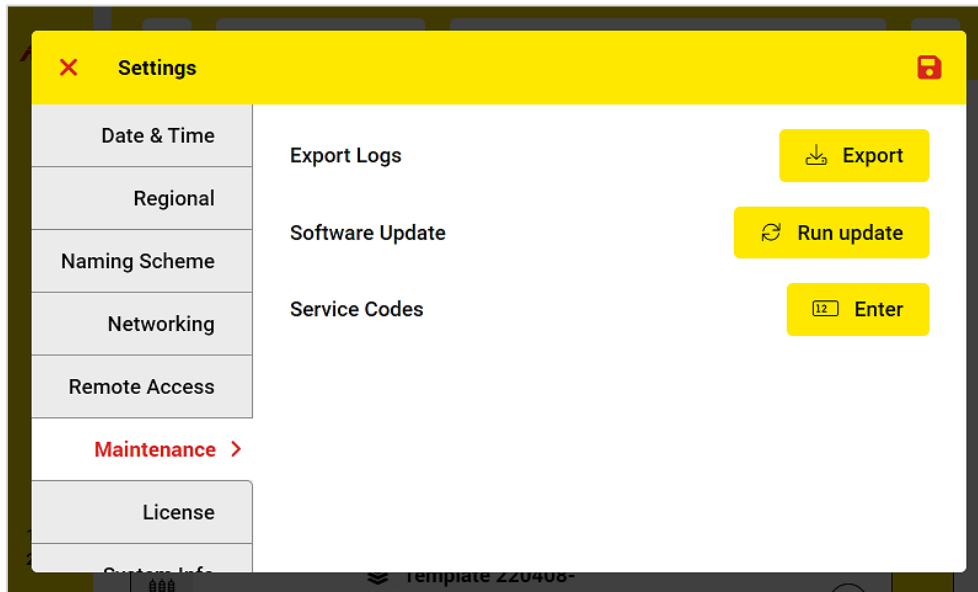

Figure 15: Maintenance tools

Export Logs

When it is required to diagnose the mini-ATOS software, the Raytech service team may ask you to export logs. To export the logs, just connect a USB stick and tap the Export button. You can later send the exported log file to the Raytech service team.

Software Update

When a new software or firmware update is available, you can copy the update file to a USB stick and connect it to the device. Then tap the Run update button and wait until the process is finished. Please do not turn off the device or unplug the USB stick during the update! The update can take up to 10min.

Service Codes

When there is a problem or error in the device, the Raytech service team may ask you to use the service codes. With service codes, it is possible to do some additional actions which are not possible to do by using the default software. These actions can be for example a self-test for diagnosing the hardware.

7.4.7 License

To activate the main firmware functionality or a specific optional measurement feature, you have to add a license code in this tab (Figure 16). Just tap the Add  button and enter the license code. Each license may be valid for a limited time like 10 days or can be unlimited.

To test a feature, you can ask Raytech for a trial license to activate the feature temporarily.

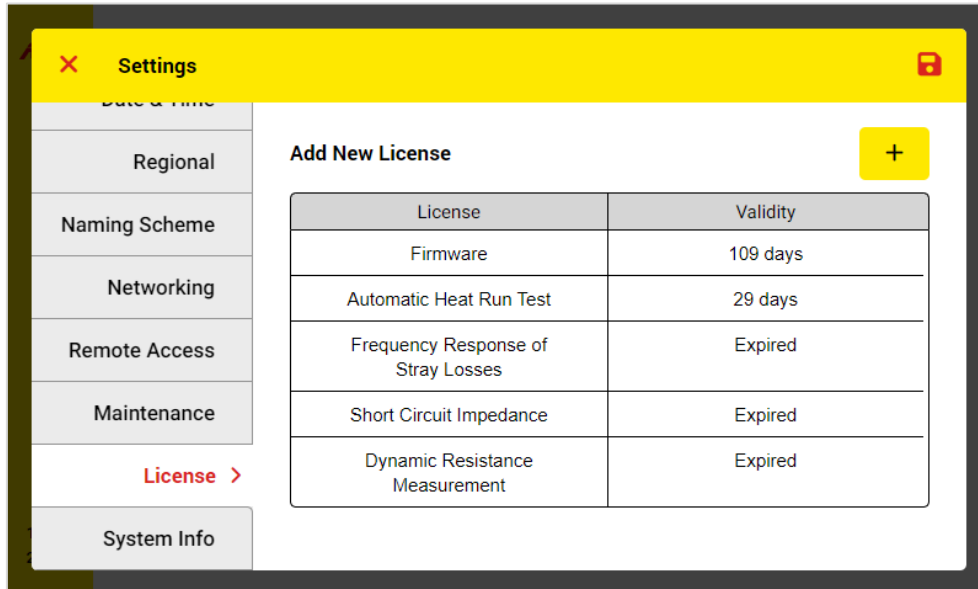

Figure 16: License manager

8 Test Objects

8.1 Power Transformer

In the TEST OBJECT window, a new test object can be defined or an existing test object can be modified. Figure 17 represents the test object window.

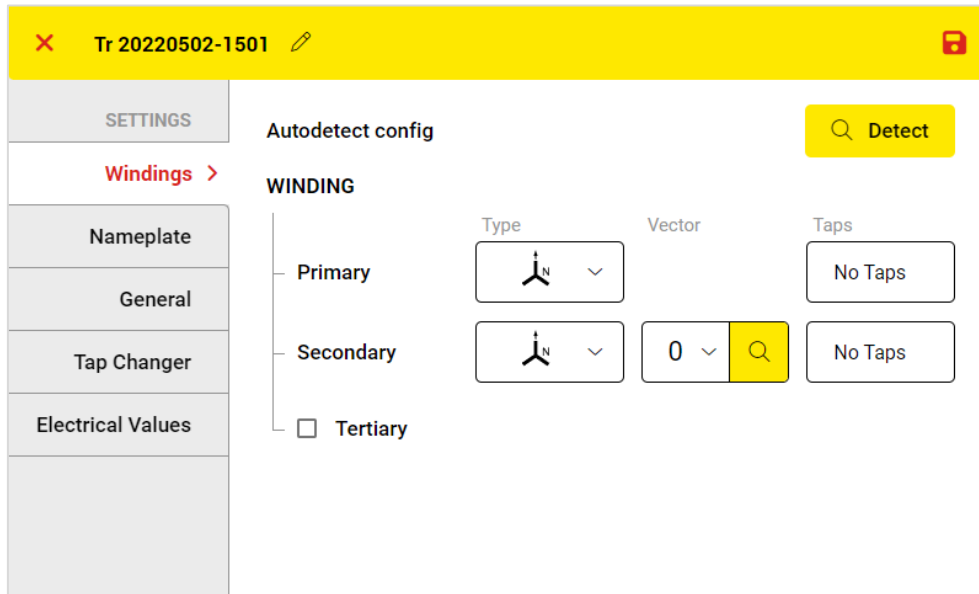



Figure 17: The test object window

Test Object Name

Tr 20220502-1501 

Name of the test object, which is helpful for easy identification. The system always assigns an automatic name at the beginning which consists of the test object type, date and time. This name can be easily changed by tapping the pencil symbol or the name.

 **Save**

Tap the Save icon to store all the entered test object data and go to the test plan.

 **Cancel**

By tapping this icon, you can cancel the test object defining and go back to the Home Screen. Please take care because all the entered data will not save.

8.1.1 Windings

In the Windings tab (Figure 18), the most important properties of the test object, including winding types, vector groups and the number of taps can be defined. After creating the test object, it is not possible to make changes in the winding information.

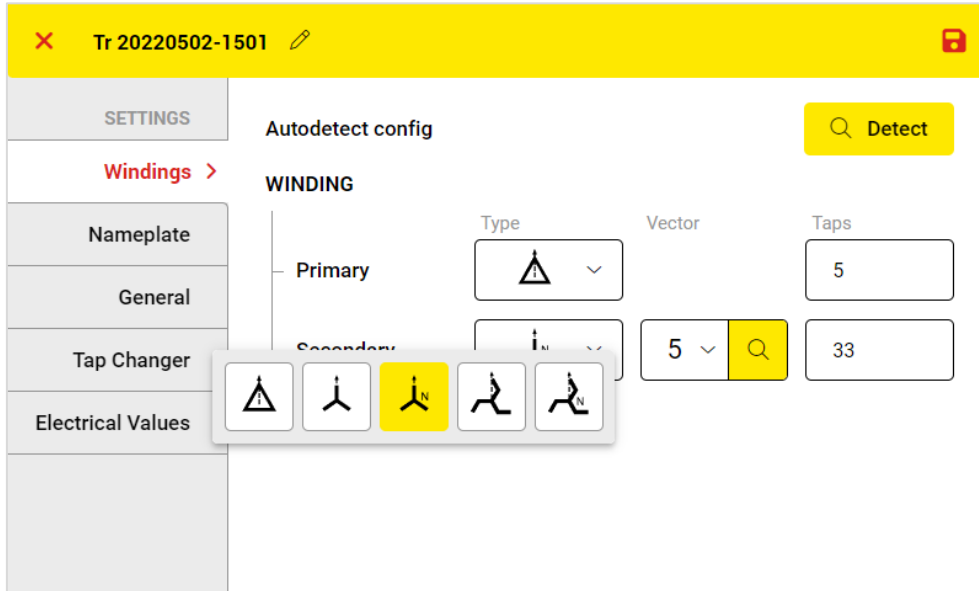









Figure 18: Test object windings tab

You can select the winding type by tapping the winding connection symbol for each winding side. The winding type can be from any winding type of Table 5:

Table 5: Winding types and symbols

Phases	Type	Letter (Primary)	Letter (non-Primary)	Symbol
3-Phases	Delta	D	d	
	Star with accessible neutral	YN	yn	
	Star	Y	y	
	Zigzag with accessible neutral	ZN	zn	
	Zigzag	Z	z	
1-Phase	Single-phase	S	s	

 **Detect**

By tapping the Detect button, the transformer winding configuration detection window will be opened and it is possible to find the winding configuration and vector group by measurement automatically. Please see chapter 08.1.2 for more details.

For all non-Primary windings, the vector group must be correctly selected. It is really important to make sure that the vector group is correct because the switching function of the automatic multiplexer is based on the vector group and winding type.

 **Detect Vector Group**

It is also possible to detect just the vector group quickly by using this button. It detects only the vector group and not the winding configuration.

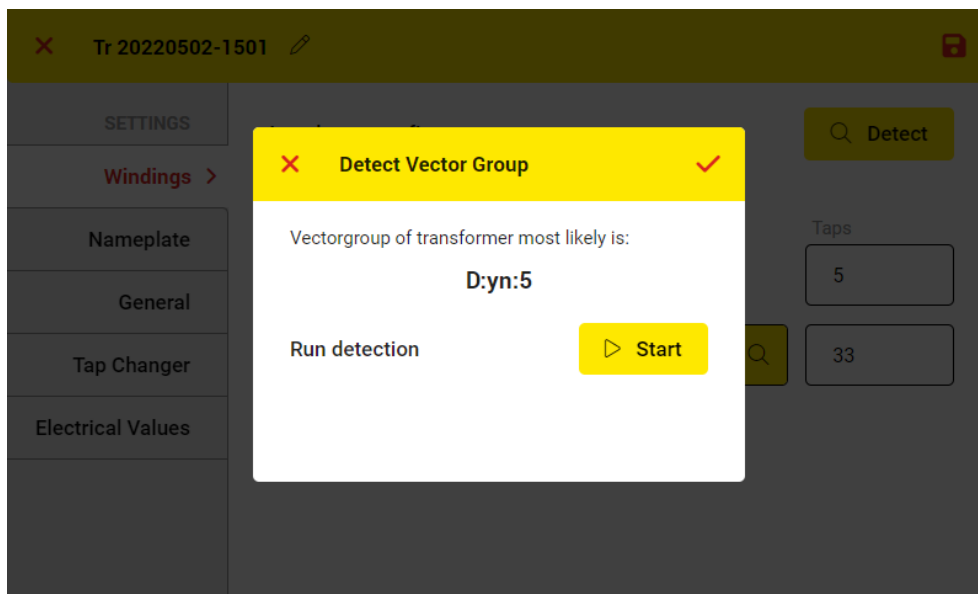

Figure 19: Detect vector group

For each winding, when there are several taps, the number of taps can be entered by clicking on the taps column. In the tap count window (Figure 20) the tap numbers can be easily adjusted. You can also enter the number of taps directly with the virtual keyboard by tapping the taps number directly.

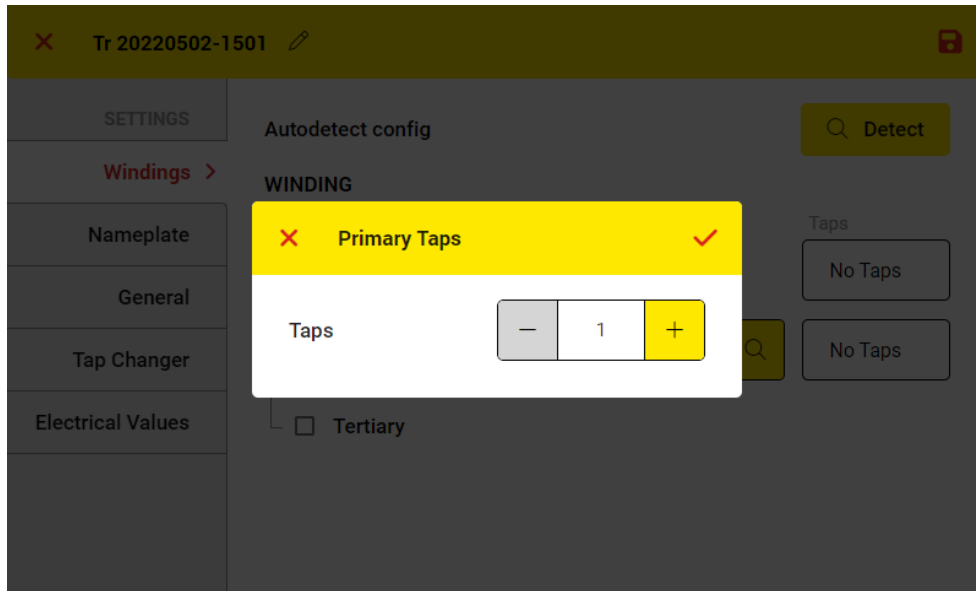

Figure 20: Tap count configuration window

When there is a tertiary winding, the check box can be selected and like the secondary winding, the required information can be entered (Figure 21).

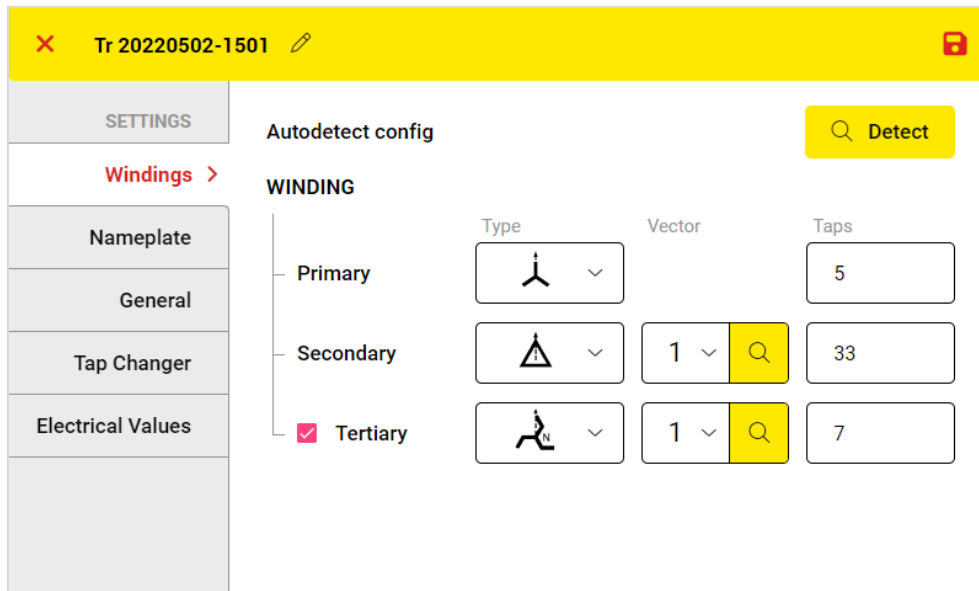

Figure 21: Defining a transformer with a Tertiary winding

8.1.2 Winding Configuration Autodetect

Autodetect feature can detect the winding configuration and vector group of the test object. During detection, the test cables must be connected to the test object terminals according to 5.1.

By tapping the Detect button in the test object windings tab (Figure 18) a new window will be opened (Figure 22). To perform the transformer detection, tap the Start and wait until mini-ATOS find the configuration.

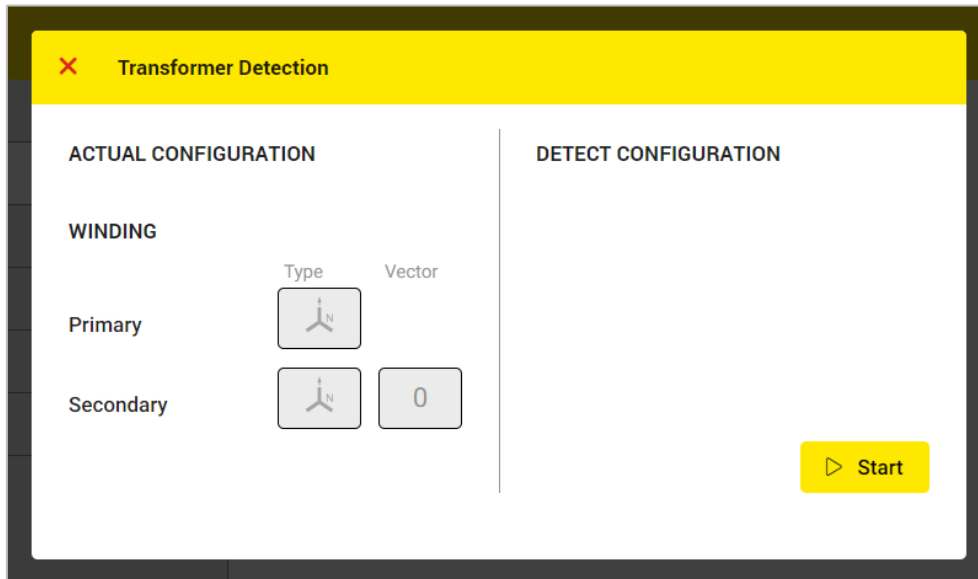

Figure 22: Winding configuration autodetect window

The actual configuration is written on the left side, and the detected configuration will be written on the right side (See Figure 23). When mini-ATOS find more winding configurations, a list of them will be provided and you can choose each of them. After detection, you can accept the detected configuration or you can cancel.

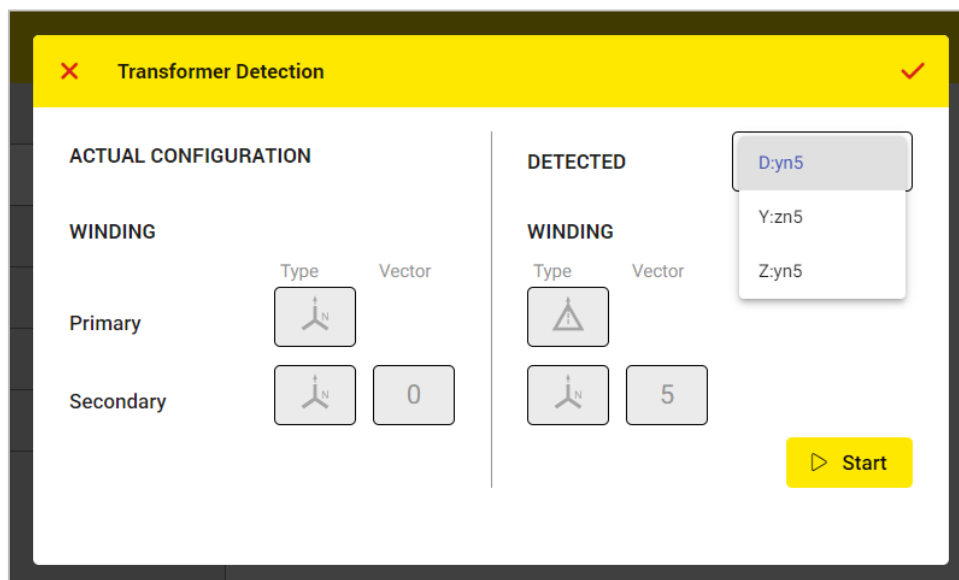
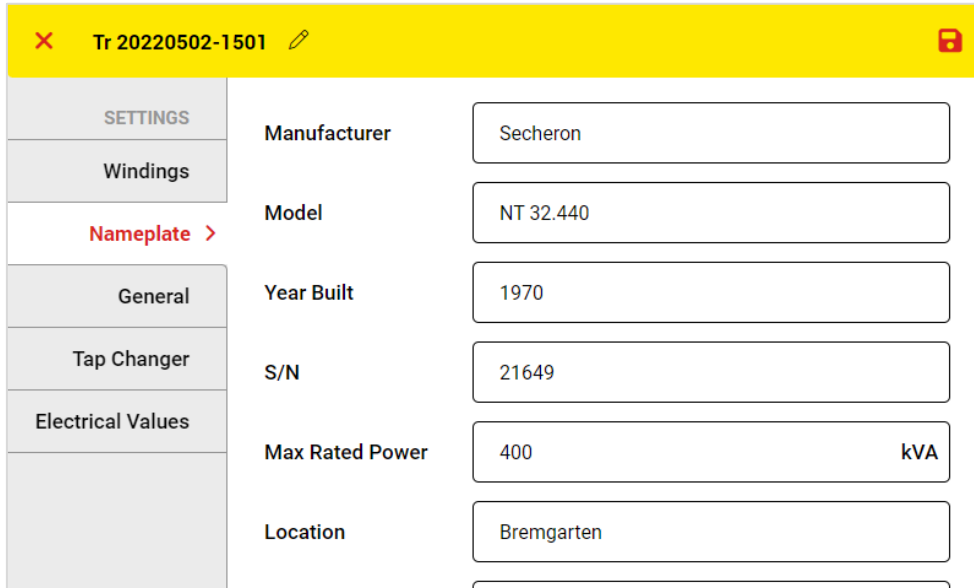

Figure 23: Winding configuration autodetect window after detection

8.1.3 Nameplate

Figure 24 shows the Nameplate tab. When nameplate data is available, it can be entered in this part. By tapping each text field, the keyboard will be opened and the data can be easily entered. The nameplate data is optional to enter. It is also possible to add this information later by editing the test object.



Tr 20220502-1501	
SETTINGS	Manufacturer: Secheron
Windings	Model: NT 32.440
Nameplate >	Year Built: 1970
General	S/N: 21649
Tap Changer	Max Rated Power: 400 kVA
Electrical Values	Location: Bremgarten

Figure 24: Test object Nameplate tab

8.1.4 General

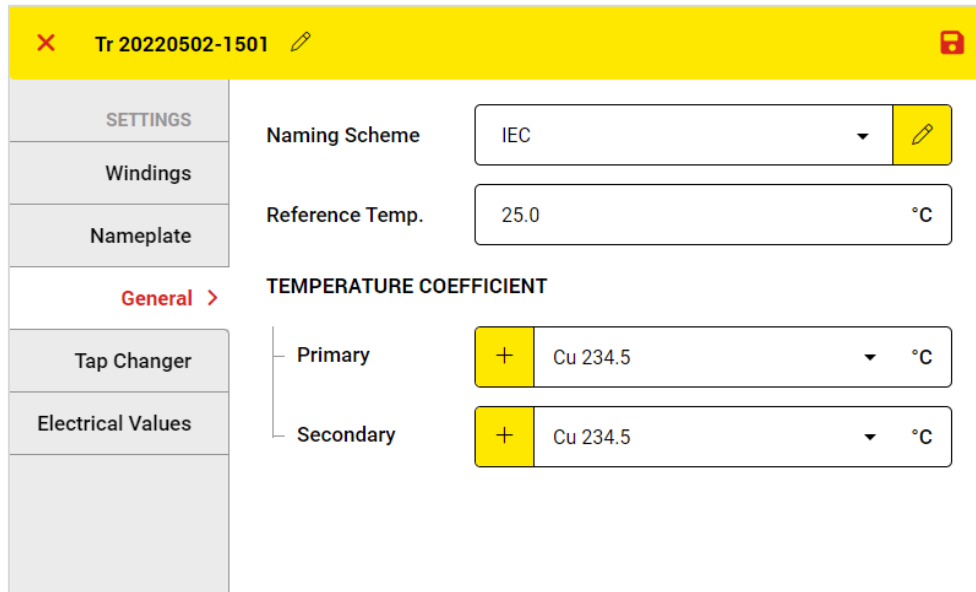

Category	Value
Naming Scheme	IEC
Reference Temp.	25.0 °C
TEMPERATURE COEFFICIENT	
Primary	+ Cu 234.5 °C
Secondary	+ Cu 234.5 °C

Figure 25: Test object General tab

In the test object general tab (Figure 25), the following information can be entered.

Naming Scheme

Generally, there are different systems of terminal naming for each test object. The naming scheme of the current test object can be selected here. When a custom naming scheme is required, it can be easily defined in the Naming Scheme window (Figure 26) which can be opened using the pencil icon.

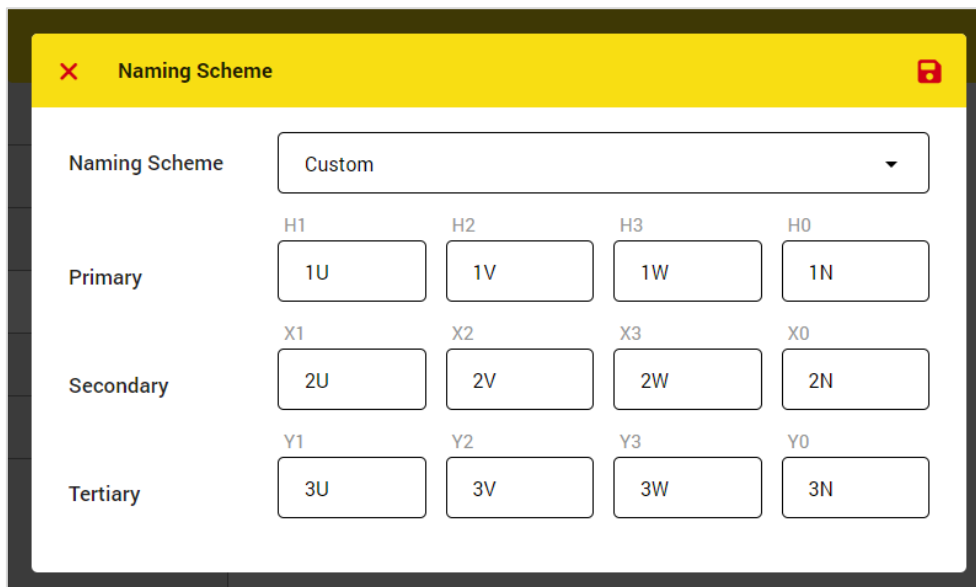

Category	H1	H2	H3	H0
Primary	1U	1V	1W	1N
Secondary	X1	X2	X3	X0
	2U	2V	2W	2N
Tertiary	Y1	Y2	Y3	Y0
	3U	3V	3W	3N

Figure 26: Custom Naming Scheme window

Reference Temperature

The reference temperature which is required for the temperature correction can be set here. For more details about the temperature correction principle, please see chapter 4.2.2.

Temperature Coefficient

The temperature coefficient which is required for the temperature correction can be set here for each winding. If a custom coefficient is required, the value can be added using the plus icon. For more details about the temperature coefficient, please see chapter 4.2.2.

8.1.5 Tap Changer

In the tap changer tab (Figure 27), the tap changers type for each winding side, possibility to control the tap changer automatically and the maximum tap changing transition time can be entered. These are especially useful when the user would like to use the automatic tap control feature.

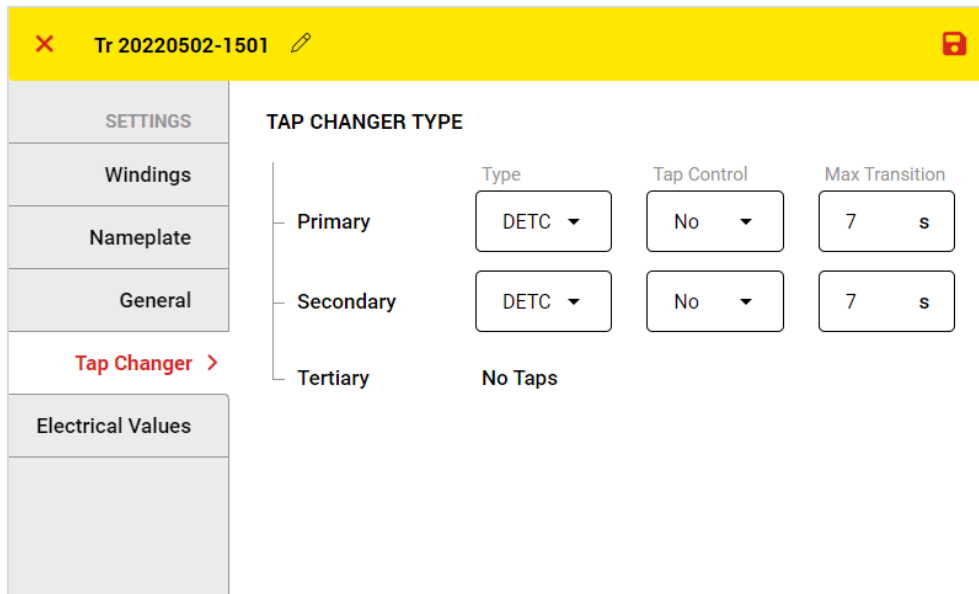

Figure 27: Test object tap control tab

Type

When there is more than one tap for a winding side, it means that the winding is equipped with a tap changer. Tap changers can be categorized in two main types: DETC and OLTC. DETC (DeEnergized Tap Changer) which can operate only when the transformer is not energized and OLTC (On Load Tap Changer) which can operate even when it is energized.

It is also very important to select the tap changer type correctly. For OLTC, it is possible to measure the DC resistance for several taps (please see chapter 11) without turning off the DC power supply.

Tap Control

If you connect the mini-ATOS tap control output to the tap changer control unit, choose Yes. The tap changer position then can be changed manually or automatically from the mini-ATOS. To find out how to connect the tap control cable, please refer to chapter 13.5.

Max Transition

The maximum transition time which it takes for a tap changer with a motor to change the tap position.

8.1.6 Electrical Values

In the test object electrical values tab (Figure 28), the rated voltage and label for each tap can be entered. The Rated Voltages later will be used as reference values for turns ratio relative error calculations and Labels will be used as tap names.

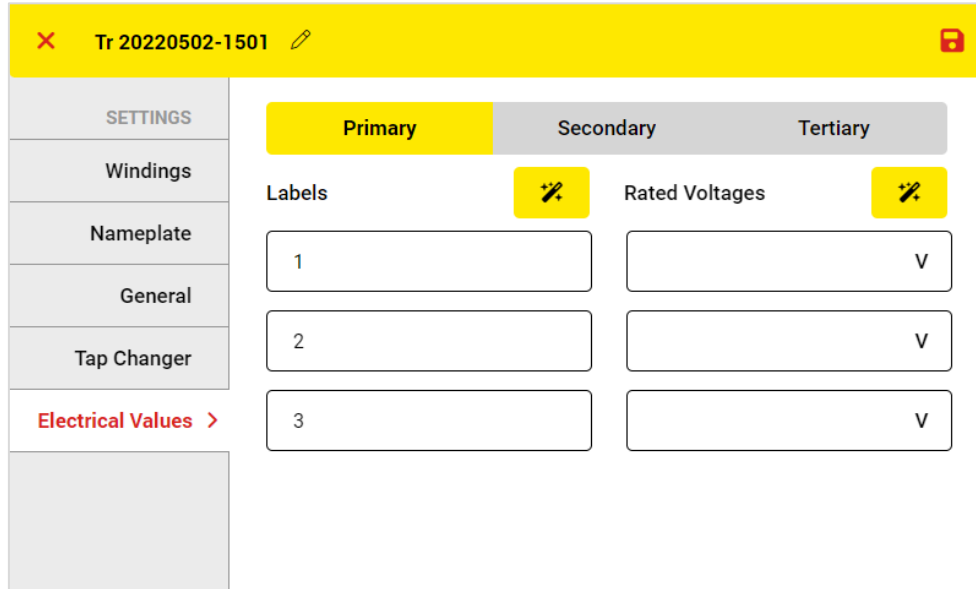

Figure 28: Test object Electrical Values tab

For each winding, the nominal voltage value and label of each tap should be entered. It is also possible to use wizards to enter the values easier. Following example, by using the power transformer with tap information according to Table 6, explain how they work.

Table 6: Example: power transformer information

Primary Taps		Secondary Taps					
Label	Voltage [V]	Label	Voltage [V]	Label	Voltage [V]	Label	Voltage [V]
1	70350	16R	14399	5R	13499	6L	12599
2	68675	15R	14317	4R	13417	7L	12517
3	67000	14R	14235	3R	13335	8L	12436
4	65325	13R	14154	2R	13254	9L	12354
5	63650	12R	14072	1R	13172	10L	12272
		11R	13990	N	13090	11L	12190
		10R	13908	1L	13008	12L	12108
		9R	13826	2L	12926	13L	12026
		8R	13745	3L	12845	14L	11945
		7R	13663	4L	12763	15L	11863
		6R	13581	5L	12681	16L	11781

Rated Voltages Wizard

In the Rated Voltages Wizard, there are two calculation methods:

First/Last method

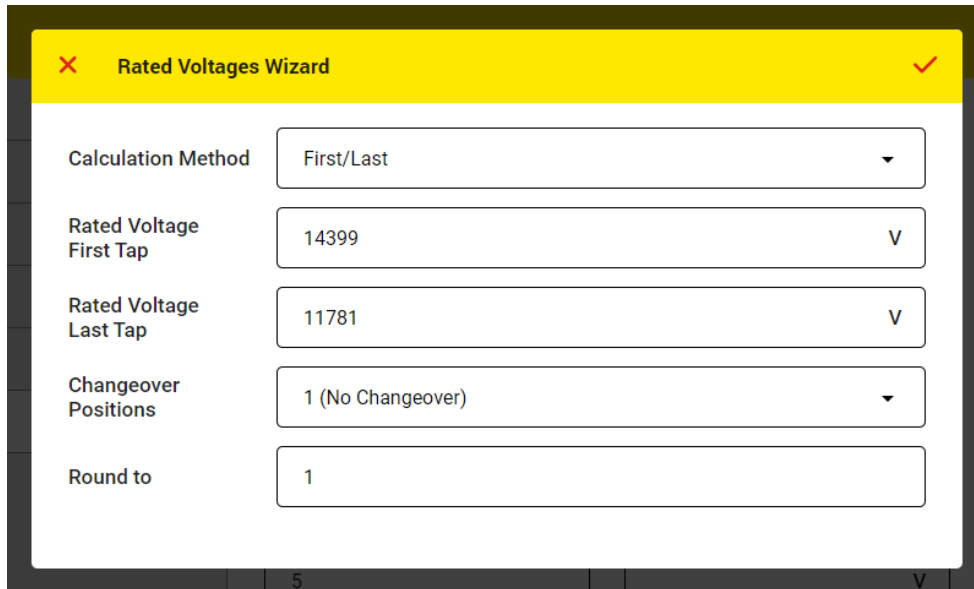

The screenshot shows a software window titled "Rated Voltages Wizard" with a yellow header bar. The window contains five input fields:

Calculation Method	First/Last
Rated Voltage First Tap	14399 V
Rated Voltage Last Tap	11781 V
Changeover Positions	1 (No Changeover)
Round to	1

Figure 29: Rated Voltage Wizard, First/Last method

In this method, we have to enter the first tap and the last tap Ph-Ph nominal voltage. Figure 29 shows how to fill the form for the secondary side of the example.

Some transformers have tap changer changeover with more than one tap with the same voltage in the middle. In such cases, the number of changeover positions with the same voltage has to be also entered.

To match the calculated values to nameplate values, it is also possible to say the wizard how to round the calculated values. The default value is 1, which means that all calculated values round to the nearest natural number.

RefTap/Step Method

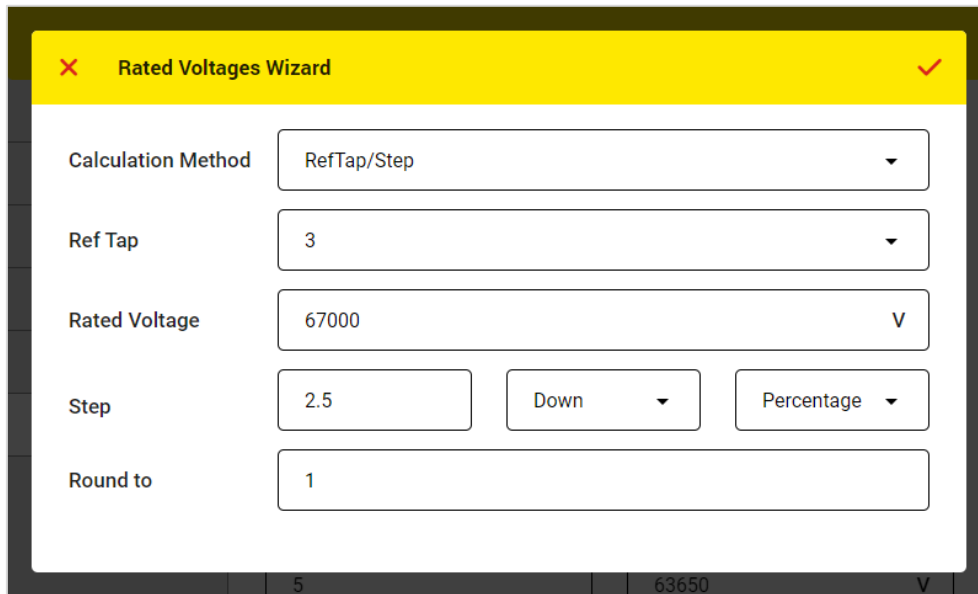

Figure 30: Rated Voltage Wizard, RefTap/Step method

In this method, by entering the rated voltage of the reference tap position and the step value between each two tap positions, all nominal voltages for all tap positions will be calculated and filled out automatically.

The RefTap is the tap position of the transformer rated voltage. The reference tap is usually the middle tap position.

The Rated Voltage is the Ph-Ph rated voltage of the power transformer which is always written on the nameplate.

The step voltage amount can be in V per step or % per step. The amount can be determined from the nameplate by subtracting the voltage values of two consecutive taps which are usually written on the nameplate.

Figure 30 shows how to fill the wizard for the primary side of the example.

When the tap changer is located on the primary side, usually the nominal voltage of the first tap is the highest voltage and for the other taps, the nominal voltage decreases. In this case for the direction, Down must be selected. The opposite is usually valid for the transformers with a tap changer on the LV side and Up must be selected for the Direction.

To match the calculated values to nameplate values, it is also possible to say the wizard how to round the calculated values. The default value is 1, which means that all calculated values round to the nearest natural number.

 **Labels Wizard**

If the default label does not match the actual tap labels, the Labels Wizard will be helpful to define a label for each tap easier. Figure 31 shows the Labels Wizard window. The first item is the Labelling pattern which is used to choose the system of labelling. When there are changeover positions, their labels can be adjusted by using the Changeover suffix item.

When it is required, by editing the Offset, it is possible to start the labelling from any number.

Finally, there is a Preview, which shows how will be the labels by using the wizard.

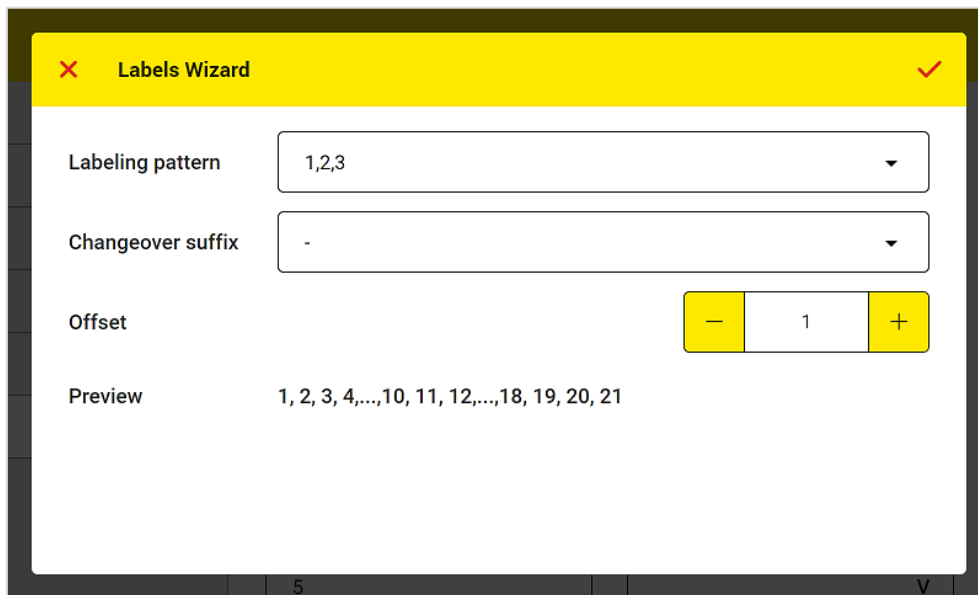

Figure 31: Labels wizard window

Figure 32 shows also how to fill the wizard for the secondary side of the example.

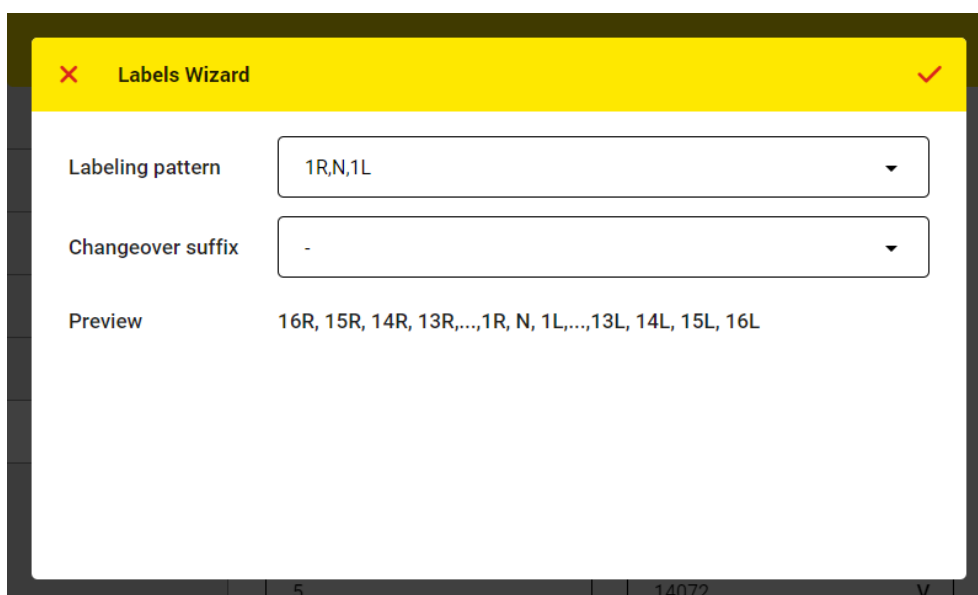





Figure 32: filling the labels wizard for the example

9 Inspection and Test Plan

In the lifetime of a high voltage asset, usually a measurement or group of measurements have to be performed periodically and also sometimes occasionally. The aim is to inspect the health condition or to detect the suspected failures. In mini-ATOS, each group of measurements is called a Test Plan which forms an Inspection.

Figure 33 shows an example of a test plan for a 3-phase power transformer. It consists of a turns ratio test, a winding resistance test and a demagnetization.

You can enable the edit mode (Figure 34) to adjust the order of measurements and add or remove them by tapping the edit icon . You can touch and hold the move icon  and try to change the position of each measurement item.

In each measurement item, it can be seen that the measurement Settings and the number of the tests performed from all the tests possible to perform are written. When you tap the measurement settings button , the setting window will be opened from the right side. To find out which settings are there for each measurement, please refer to chapter 10 and see each measurement method settings.

By tapping the yellow right arrow, the measurement view will be opened and from there it is possible to perform the test.

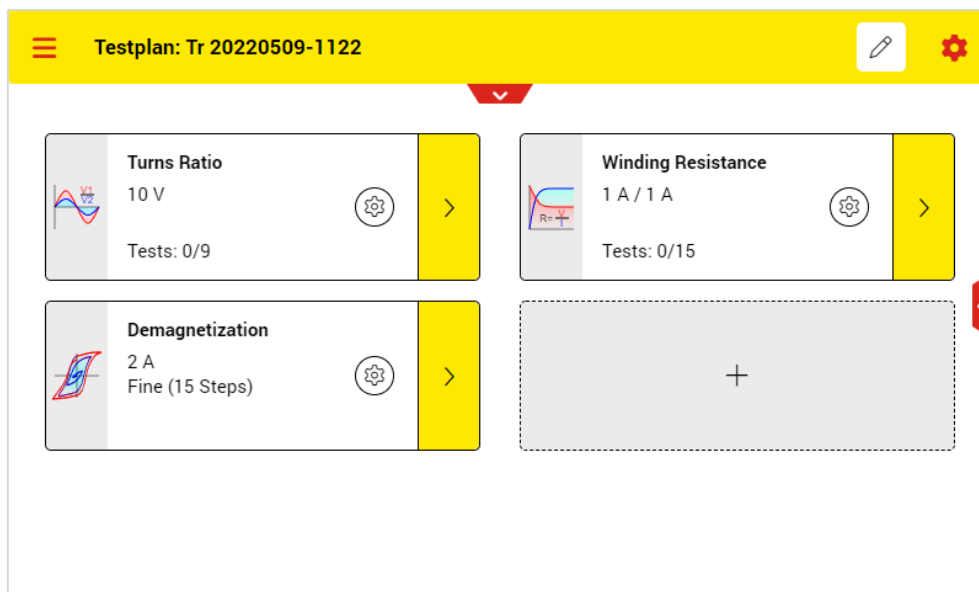

Figure 33: A Test Plan for a 3-phase power transformer

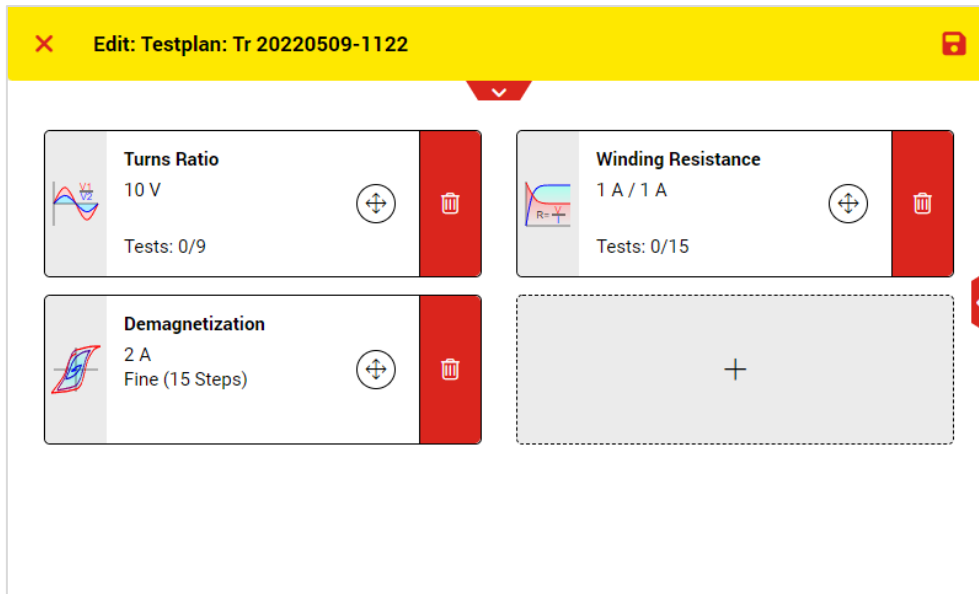

Figure 34: Test Plan edit mode

For the transformers with tertiary winding, for each pair of windings (Pri: Sec & Pri: Ter), there is a separate test plan. To see the test plan for each one, the desired pair of windings must be selected from the drop-down list located above (Figure 35). This drop-down list is only visible when there is a tertiary winding.

Note that when you select another pair of winding, the measurement setup must be changed according to chapter 5.1.

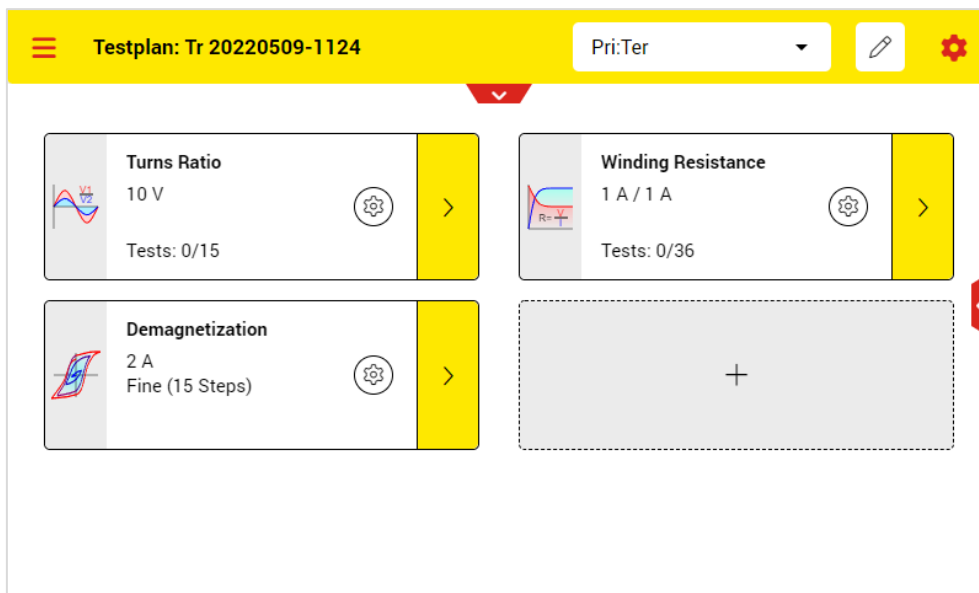

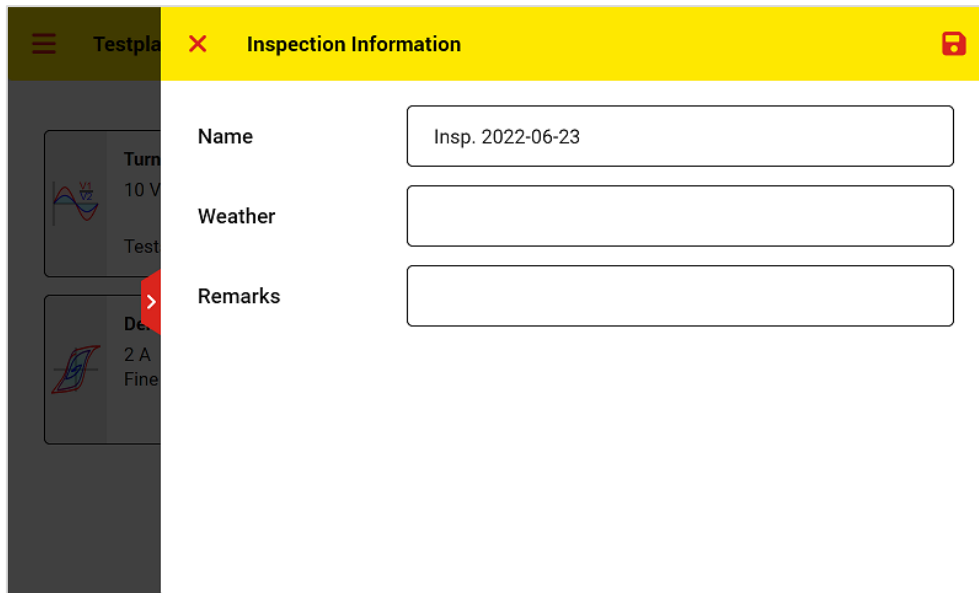

Figure 35: Test plan for Pri: Ter pair, which is selected from the drop-down list located above.

By tapping the setting icon on the top , you can open the Inspection Information (Figure 36). Here it is possible to edit the inspection name, enter the weather condition and write additional notes like the reason for the inspection as remarks for later references.



The screenshot shows a mobile application interface. At the top, there is a yellow header bar with the text "Inspection Information" and a close button (X) on the left and a save icon on the right. Below the header, there is a dark grey sidebar on the left with a menu icon and a red arrow pointing right. The main content area is white and contains three input fields: "Name" with the text "Insp. 2022-06-23", "Weather", and "Remarks".

Figure 36: Inspection information

10 Measurements

10.1 Turns Ratio

Figure 37 shows the turns ratio measurement view and following that each part is explained.

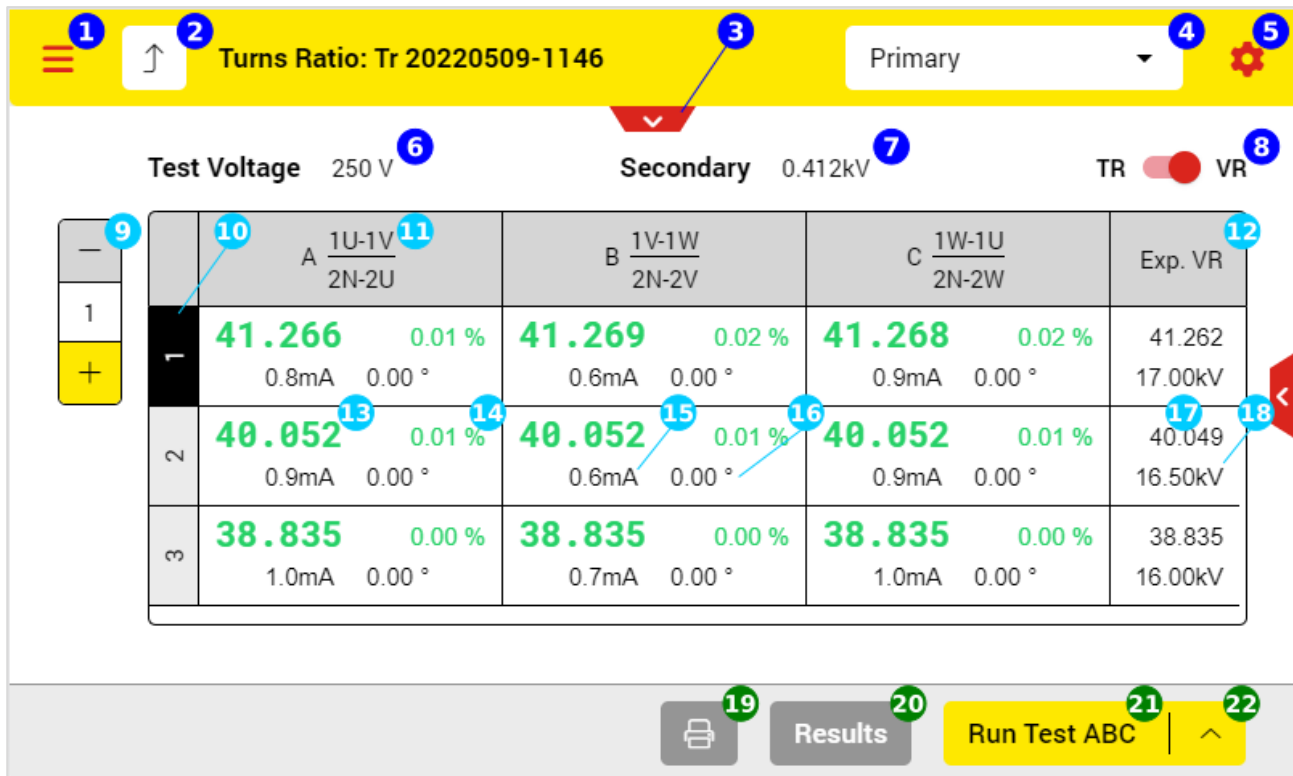

Figure 37: Turns Ratio measurement view

1	Open the main menu	13	The measured turns or voltage ratio; green means that the relative error is less than the error limit and the test is Passed
2	Back to the test plan page	14	The calculated relative error in %; green means that the relative error is less than the error limit and the test is Passed
3	Open test object quick access	15	The test current in mA
4	Select the table view mode (Please see chapter 10.1.1)	16	The measured angle between the applied voltage and the transformed voltage
5	Test settings (Please see chapter 10.1.2)	17	The rated turns or voltage ratio
6	The selected test voltage that applies on the primary side during the measurement	18	The rated voltage of each tap position
7	The secondary side rated voltage	19	Print the selected tap position results by using the thermal printer
8	Change between voltage or turns ratios	20	Open the detailed results in table view or graphs
9	The actual tap position of the selected view mode and to change it	21	Start test button
10	Tap positions of the selected view mode. The actual is with the dark background	22	Test mode to select which phase to test (A, B, C, ABC, Run Test Taps)
11	The phase and the corresponding connections which be used automatically by the instrument to test each phase		
12	Expected turns or voltage ratio		

The measurement view during the test is shown in Figure 38 and then the important parts are explained.

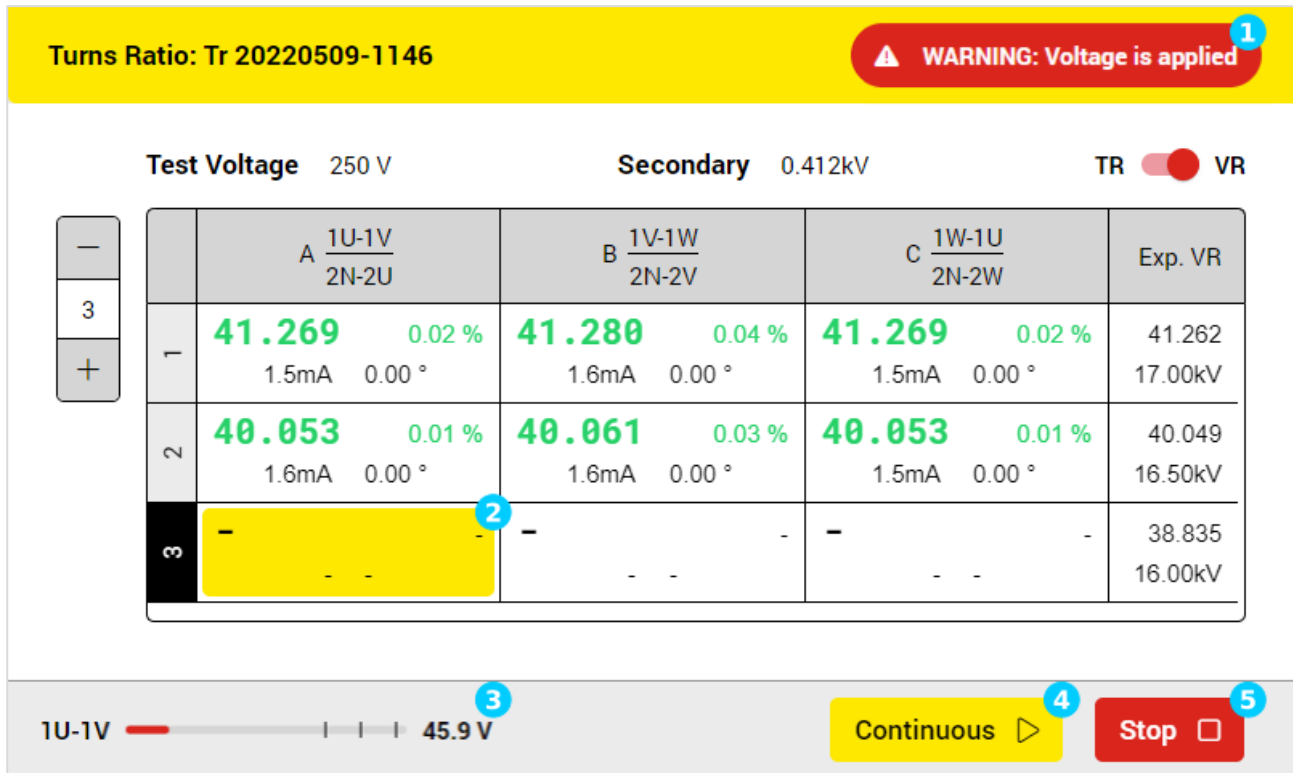

Figure 38: Turns Ratio measurement view during the test

- 1 The warning symbol shows that it is not safe to touch the cables and test clamps
- 2 The highlighted cell shows which phase and tap are currently under the test
- 3 The output voltage bar shows what is the actual value of output voltage and which terminals are used to apply the voltage
- 4 By tapping the continuous button, the test mode changes from single-measurement to continuous mode and the test will not stop automatically. The instrument keeps performing the test on the phase under the test until the user action
- 5 The stop button can be used to stop the test. Please note that it takes time to stop the test

10.1.1 Table view modes

When both primary side and non-primary side of transformer windings have tap positions, it is not easy to show all measurements for all tap combinations in one table. Hence, to show the measurements easier, there are two table view modes. The first one is the primary table view mode. In this mode, for each tap position on the non-primary side, there is a measurement table consisting all primary tap positions. The other view mode is the non-primary table view mode. In this mode, for each tap position on the primary side, there is a measurement table which includes all non-primary tap positions.

As an example, assume that there is transformer with 5 taps (1 to 5) on the primary side, and 33 taps (16R to 16L) on the secondary side. Figure 39 shows the primary view mode. In this mode for each of the secondary taps, there is table with 5 primary taps (33 tables, each 5 taps). The secondary selected tap is shown on the top and it is possible to change it.

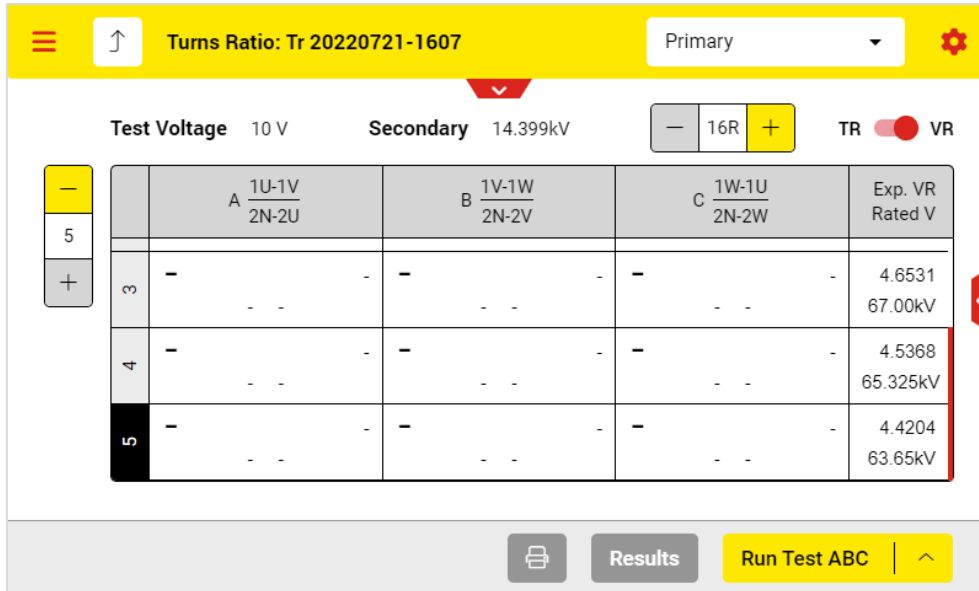

Figure 39: Turns ratio primary view mode

Figure 40 shows on the other hand the secondary view mode. This time for each of the primary taps, there is table with 33 secondary taps (5 tables, each 33 taps). The primary selected tap is also shown on the top and it is possible to change it.

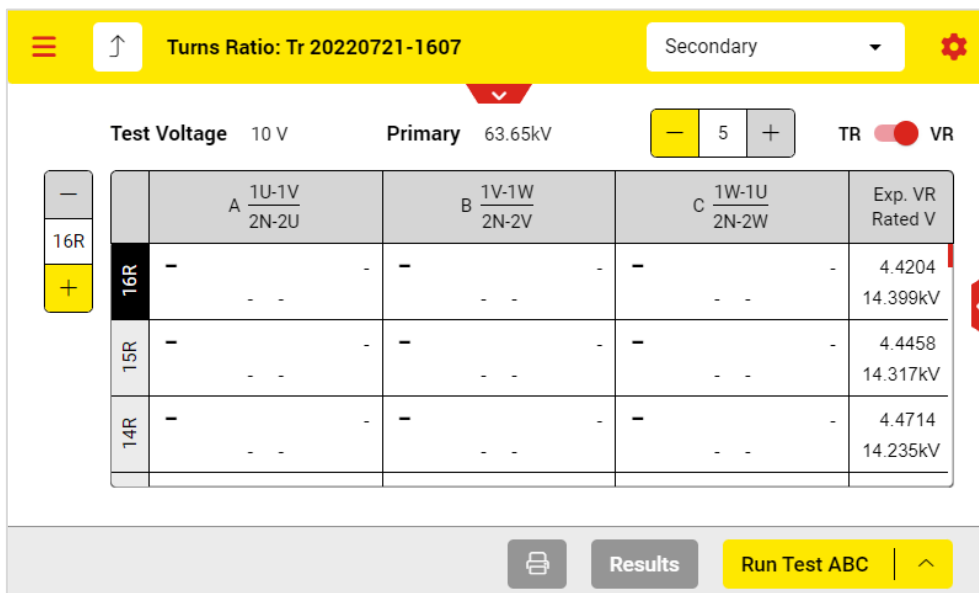

Figure 40: Turns ratio secondary view mode

10.1.2 Turns ratio settings

In Figure 41 the turns ratio setting can be seen. The test voltage can be selected from 10VAC, 40VAC, 100VAC or 250VAC.

The maximum acceptable ratio error can also be adjusted by editing the Max Error field. The default value according to standards is 0.5%.

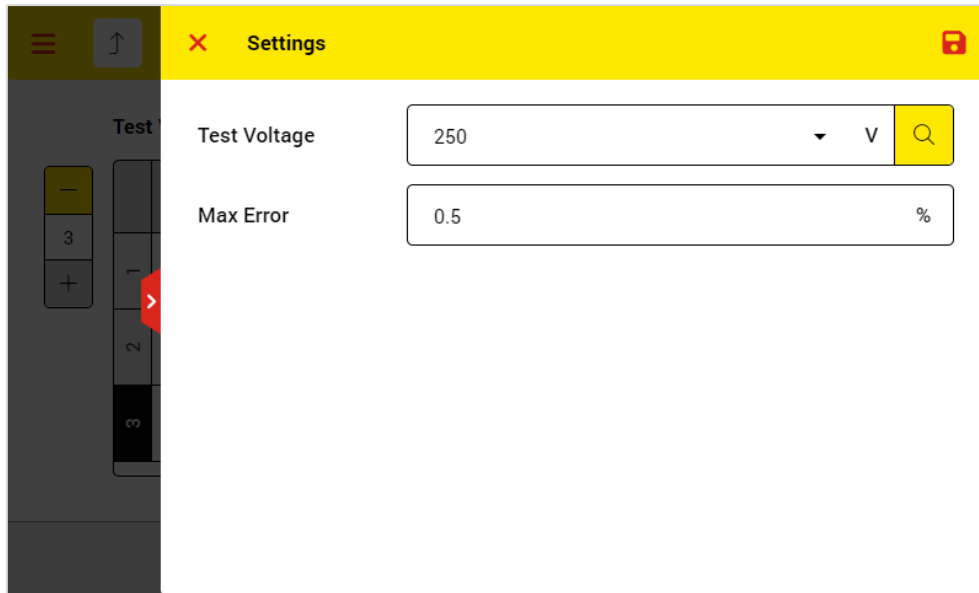

Figure 41: Turns ratio settings



Auto Detect Voltage

It is also possible to find out what is the suitable test voltage for a specific test object. Just tap the search icon, and run detection in the Auto detect voltage window (Figure 42).

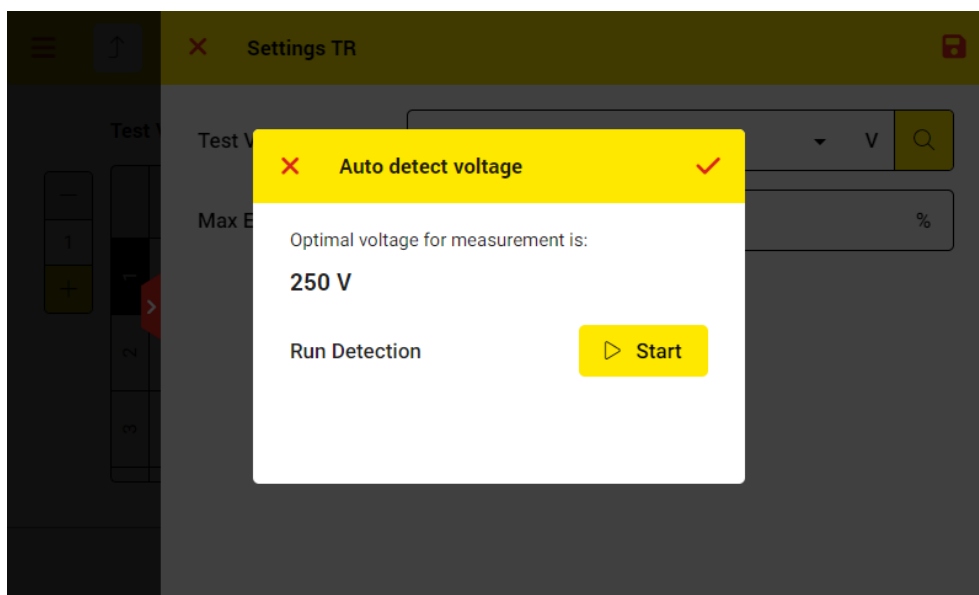

Figure 42: Turns ratio suitable test voltage auto detection

10.1.3 Turns Ratio Results View

By tapping the Results button in the turns ratio measurement view, the result view will be opened. Result view includes graphs and table. Figure 43 shows the turns ratio graph view. From the drop-down list on top right, it is possible to select various graphs. These are turns ratio, voltage ratio and error graph.

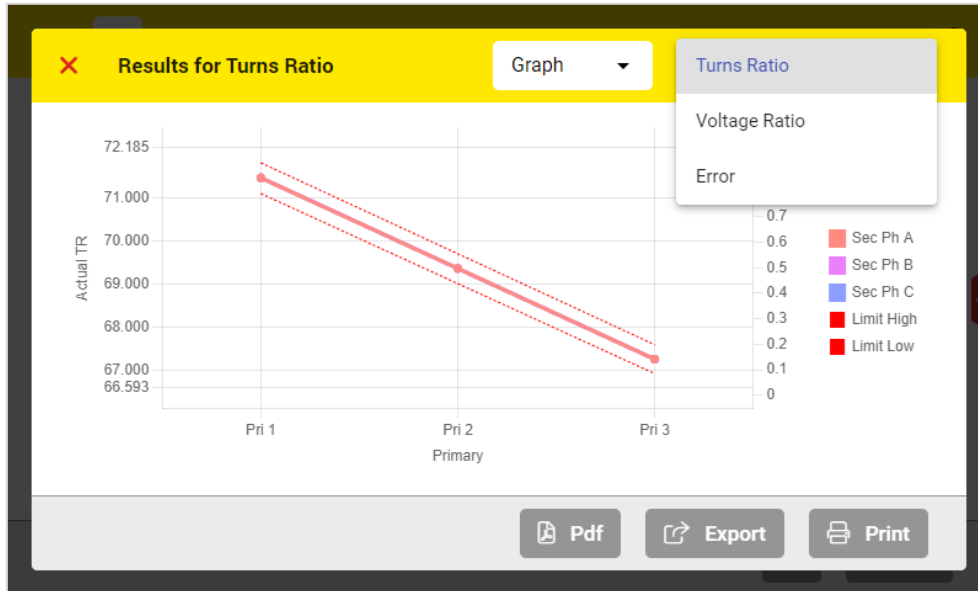

Figure 43: Turn ratio graph results view

Figure 44 shows also the turns ratio table results. By tapping the TR or the Rated TR column header, it is possible to switch between turns ratio and voltage ratio values.



Prim Tap	Prim U[V]	Sec U[V]	Ph.	TR	Rated TR	Error [%]	ITest [A]	Angle [°]	Pass
1	17.00 k	0.412 k	A	71.474	71.468	0.01	0.8 m	0.00	Yes
1	17.00 k	0.412 k	B	71.480	71.468	0.02	0.6 m	0.00	Yes
1	17.00 k	0.412 k	C	71.479	71.468	0.02	0.9 m	0.00	Yes
2	16.50 k	0.412 k	A	69.371	69.366	0.01	0.9 m	0.00	Yes
2	16.50 k	0.412 k	B	69.372	69.366	0.01	0.6 m	0.00	Yes
2	16.50 k	0.412 k	C	69.371	69.366	0.01	0.9 m	0.00	Yes

Figure 44: Turns ratio table results view

10.2 Winding Resistance

Figure 45 shows the measurement view of the primary winding resistance test and following that each part is explained.

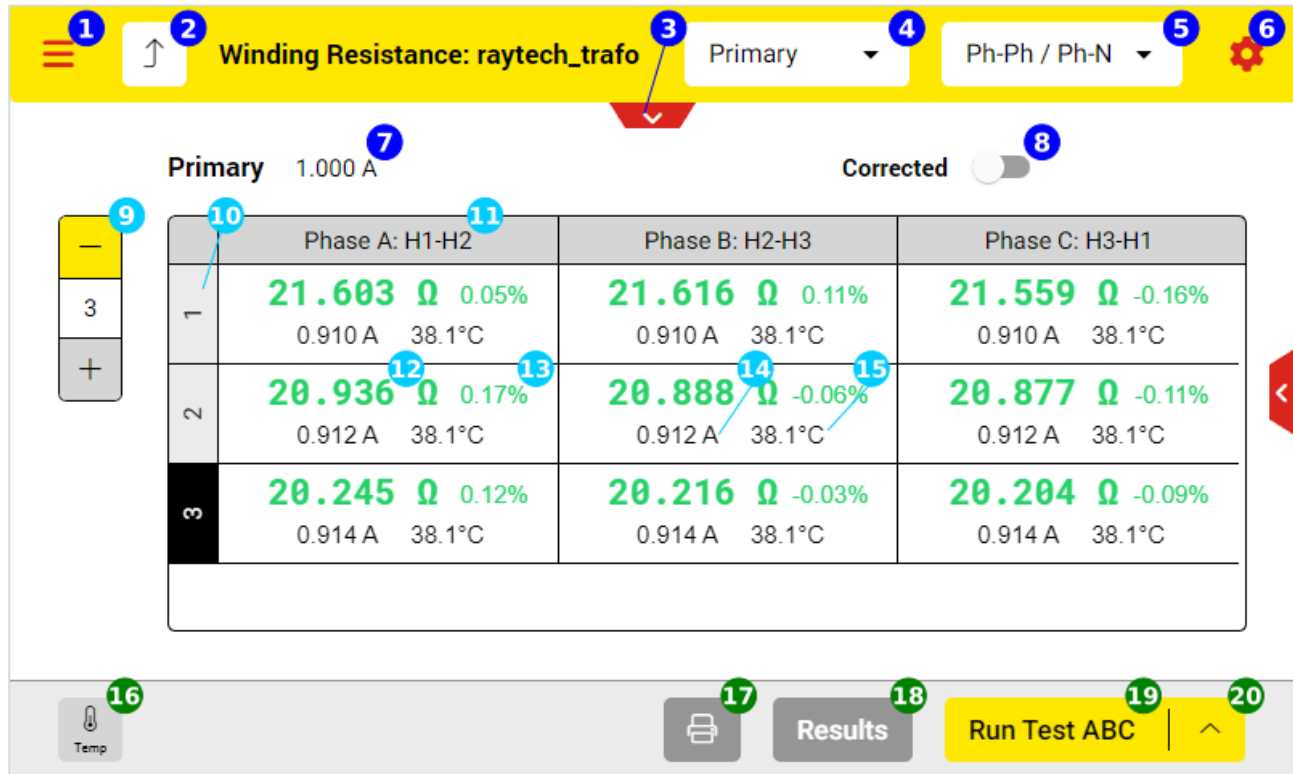

Figure 45: Winding resistance measurement view

- | | | | |
|----|--------------------------------------------------------------------------------------------------------------|----|-----------------------------------------------------------------------------------------------------------------------------------------------------------------|
| 1 | Open the main menu | | |
| 2 | Back to the test plan page | 12 | The measured winding resistance (temperature corrected or not corrected depending on selection) |
| 3 | Open test object quick access | | |
| 4 | Select the transformer's side to test or to select dual supply mode | 13 | The deviation value from the 3 phases average; green means the deviation is less than the limit and the test is Passed. See chapter 04.2.3 for more information |
| 5 | To select test phase to phase or phase to neutral measurement when possible | 14 | The actual test current which was used |
| 6 | Test settings | 15 | The measured temperature during the measurement or the reference temperature when resistance is corrected |
| 7 | The selected current that injects into the selected winding side | 16 | To see the actual measurement value of each temperature measurement channel |
| 8 | To enable or disable the temperature corrected resistances view | 17 | Print the selected tap position results by using the thermal printer |
| 9 | The actual tap position of the selected view side and to change it | 18 | Open the detailed results in table view or graphs |
| 10 | Tap positions of selected winding side. The actual is with the dark background | 19 | Start test button |
| 11 | The phase and the corresponding connections which be used automatically by the instrument to test each phase | 20 | Test mode to select which phase to test (A, B, C, ABC, Run Test Taps) |

The winding resistance measurement view during the test is shown in Figure 46 and following it, important parts are explained.

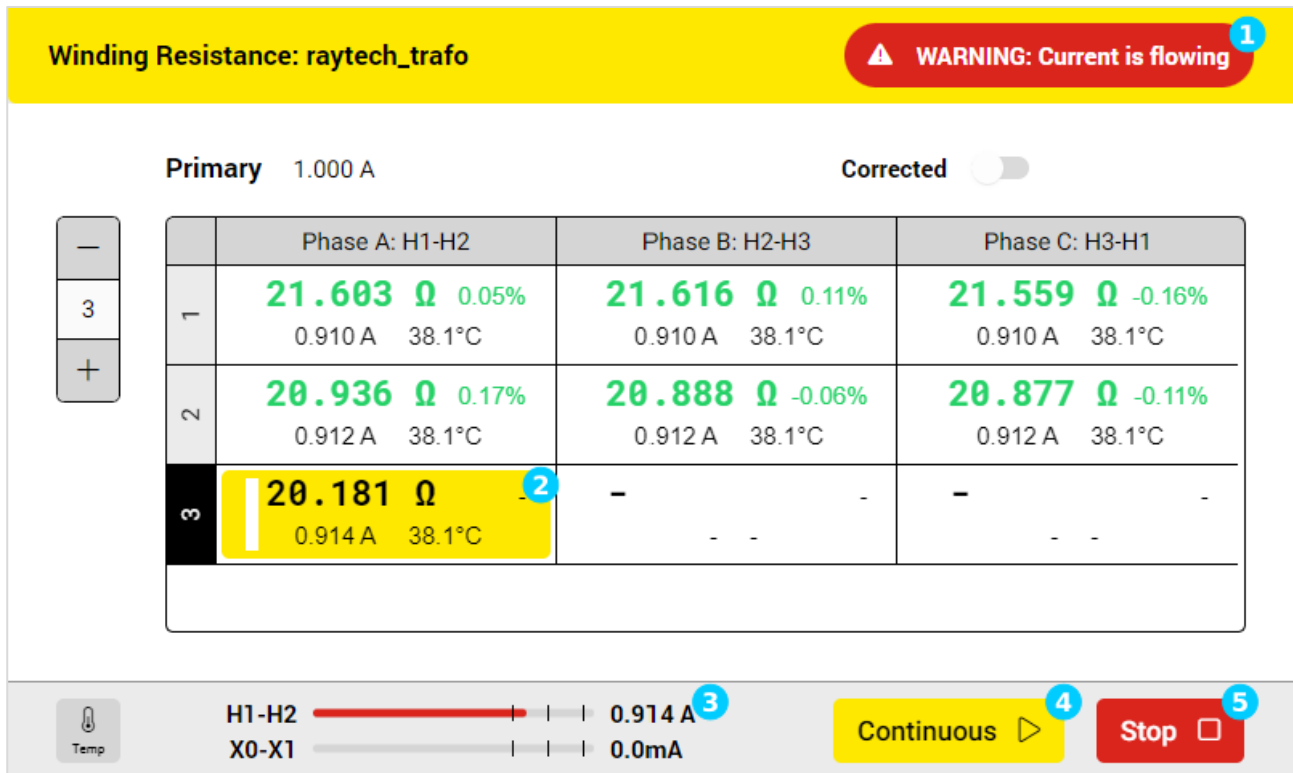

Figure 46: Winding resistance measurement view during the test

- 1 The warning symbol shows that it is not safe to touch the cables and test clamps
- 2 The highlighted cell shows which phase and tap are currently under the test
- 3 The output current bars show what is the actual value of output current for each channel and which terminals are used to inject the currents.
- 4 By tapping the continuous button², the test mode changes from single-measurement to continuous mode and the test will not stop automatically. The instrument keeps performing the test on the phase under the test until the user action
- 5 The stop button can be used to stop the test. Please note that it takes time to discharge and stop the test



WARNING!

After measurement stop, it takes time to discharge the test object! Wait until the device mode changes to safe mode before any other action!

² When the ambient temperature is above 40°C, Continuous mode winding resistance measurement, specially with maximum output power, must be limited to 30 minutes and before the next measurement a cooldown time of 30 minutes is required.

10.2.1 Dual Supply Winding Resistance

It is also possible to measure the two transformer sides simultaneously by selecting the Dual Supply mode. Figure 47, Shows the winding resistance measurement in dual supply mode and all important parts are explained.

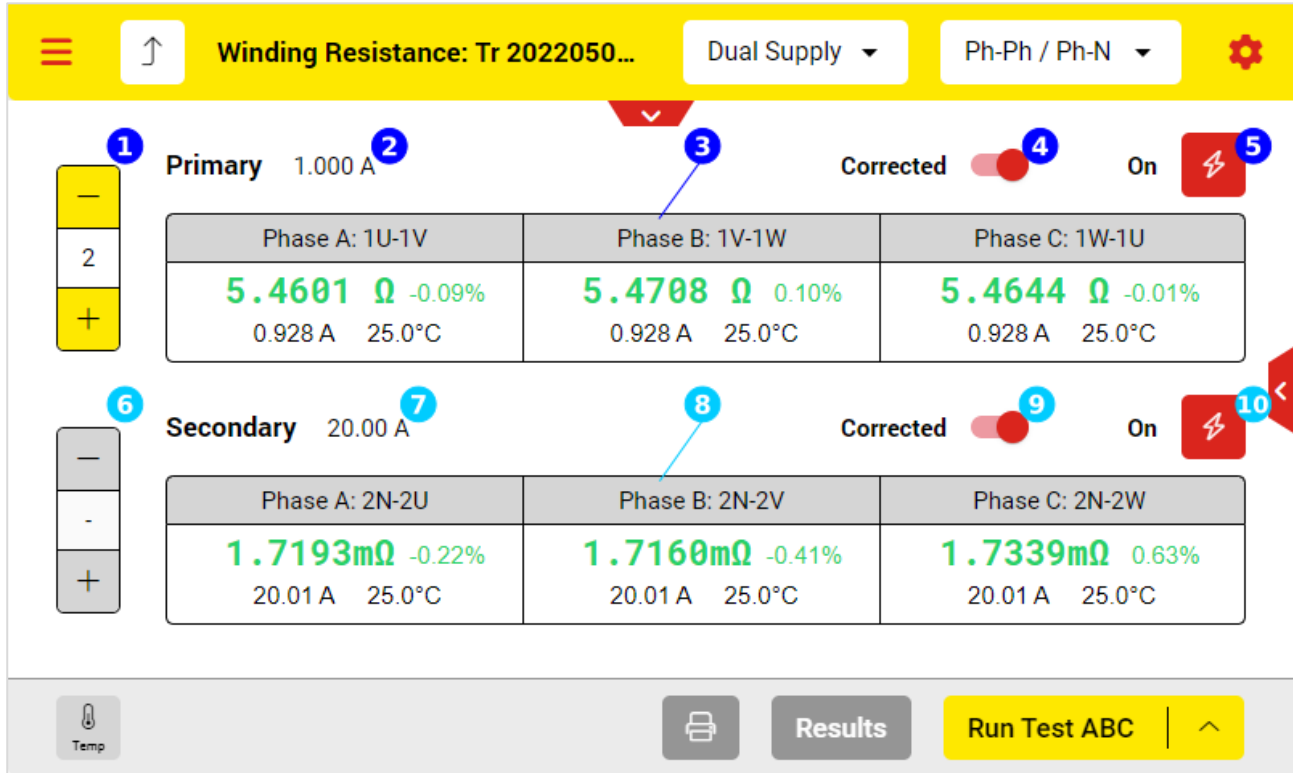

Figure 47: Winding resistance measurement in dual supply mode

- | | |
|---------------------------------------------------------------------------------------------------------------------------------------------------------------------------------------------------------------------------------------------------------------------------------------------------------------------------------------|-------------------------------------------------------------------------------------------------------------------------------------------------------------------------------------------------------------------------------------------------------------------------------------------------------------------------------------------------------|
| <p>1 The actual tap position of the primary side (if it contains a tap changer)</p> <p>2 The selected current that injects into the primary winding side</p> <p>3 The measurement table view of the primary side</p> <p>4 To enable or disable the temperature corrected resistances view for primary</p> | <p>6 The actual tap position of the non-primary side (if it contains a tap changer)</p> <p>7 The selected current that injects into the non-primary winding side</p> <p>8 The measurement table view of the non-primary side</p> <p>9 To enable or disable the temperature corrected resistances view for non-primary</p> |
| <p>To turn On or turn Off the power supply for the primary side. It is also possible to select “Charge” mode. In charge mode, the power supply injects current to the primary side to increase the transformer charging speed. But no resistance will be measured</p> | <p>5</p> <p>10 To turn On or turn Off the power supply for the non-primary side</p> |

10.2.2 Winding Resistance Settings

Figure 48 shows the winding resistance main settings.

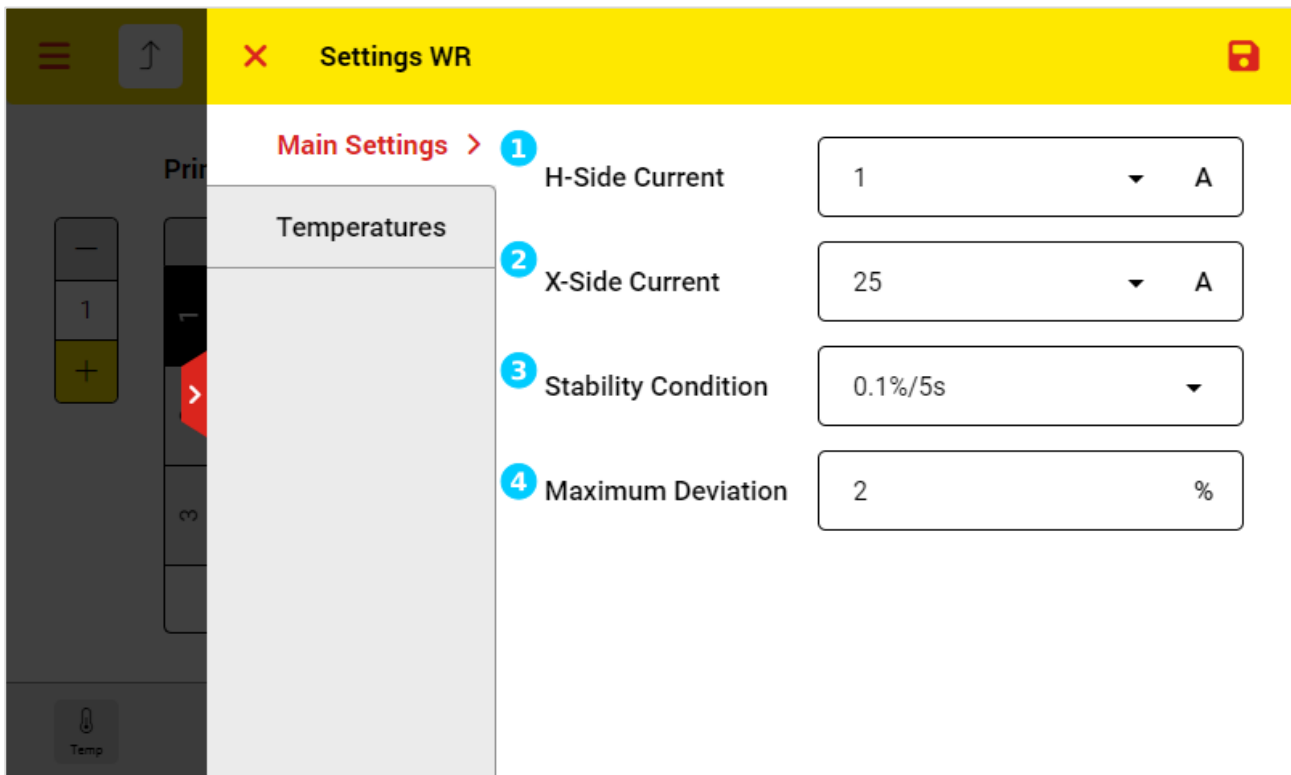

Figure 48: Winding resistance main settings

- 1 To select the H-Side current that injects into the primary winding side
- 2 To select the X-Side current that injects into the non-primary winding side
- 3 The stability condition is a reference for the device to decide if the resistance value during a measurement is considered stable or not. For example, 0.1%/5s means that if the resistance fluctuations keep less than 0.1% of the average value continuously for more than 5 seconds, it will be considered stable
- 4 The maximum acceptable deviation value. Please see chapter 4.2.3 for more information



INFO:

Do not select currents more than 10% of the test object nominal current for each side. Otherwise, current will increase the temperature and hence resistance of the winding.

Figure 49 shows the winding resistance temperature settings.

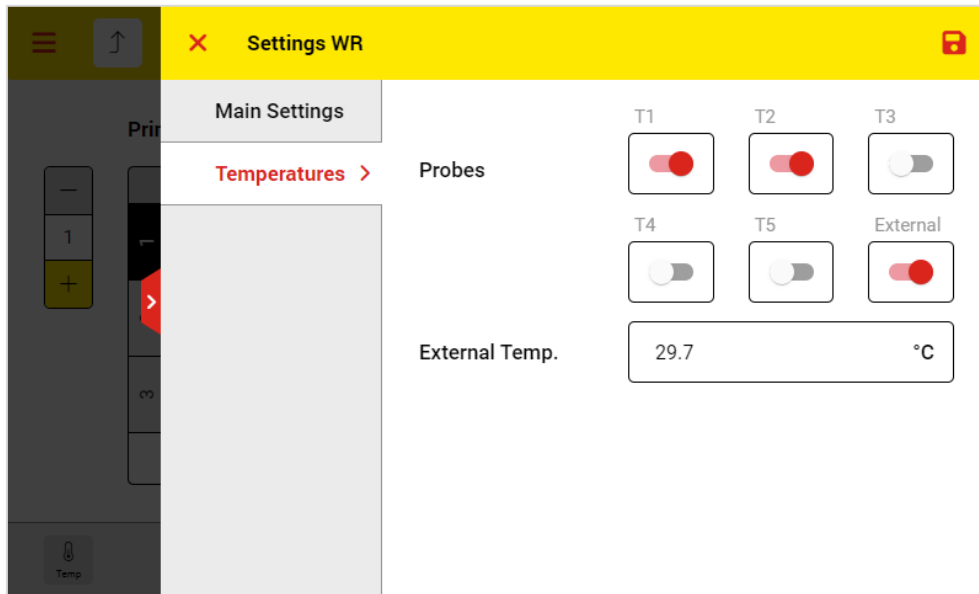

Figure 49: Winding resistance temperatures settings

In temperature settings, it is possible to enable each of the 5 temperature channels to record. When there is an external temperature probe, the External switch should be enabled. The reading value must be also entered manually.

The mini-ATOS use the average of all temperature values for the temperature correction.

In the actual temperature window (Figure 50) which you can open from the measuring screen, you can see the actual temperature values. Here T1 is plugged-in and also activated in the setting. T2 is activated but not plugged-in. In this case, the mini-ATOS shows an error message after starting the measurement. And T3 is not activated but plugged in. Please note that the average value is missing because of T2.

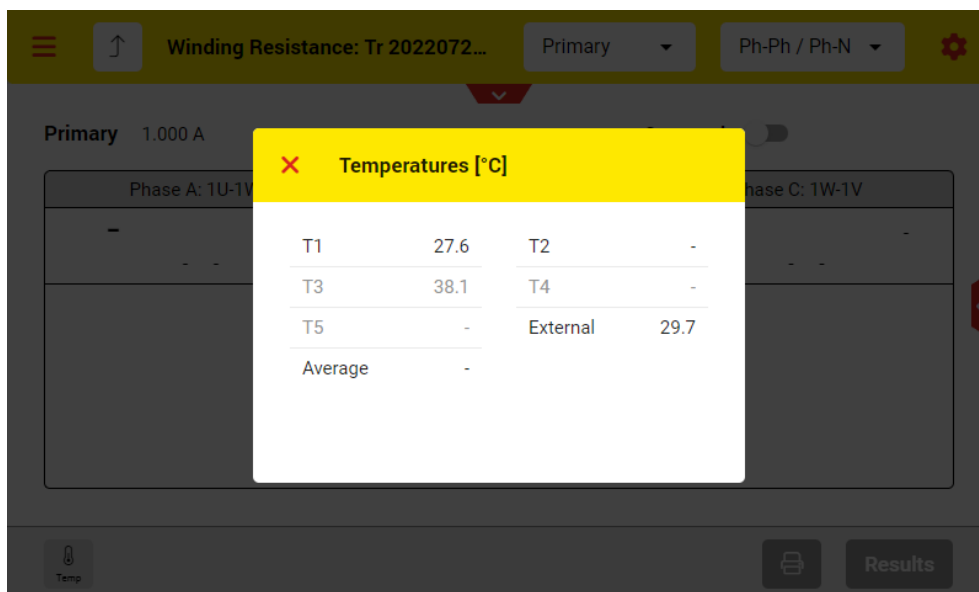

Figure 50: Actual Temperature values

10.2.3 Winding Resistance Result View

By tapping the Results button in the measurement view, the result view will be opened. Result view includes graphs and table. Figure 51 shows the Primary (Ph-Ph) winding resistance graph view. From the drop-down list on top right, it is possible to select also other graphs.



Figure 51: Winding resistance graph results view

Figure 52 shows also the Primary (Ph-Ph) table results. By tapping the DevCorr column header, it is possible to switch between deviation for measured values or temperature corrected values.

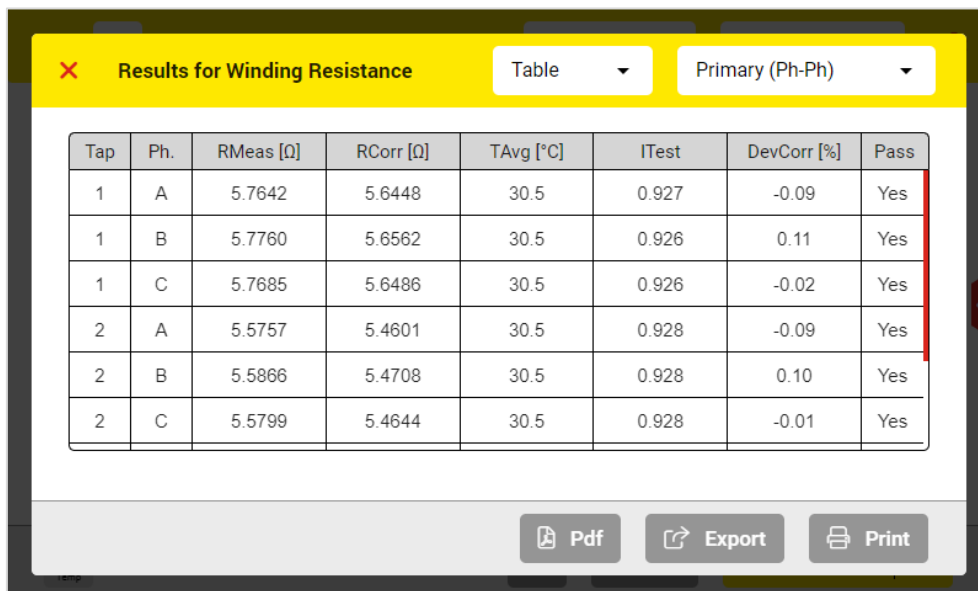

Tap	Ph.	RMeas [Ω]	RCorr [Ω]	TAvg [°C]	ITest	DevCorr [%]	Pass
1	A	5.7642	5.6448	30.5	0.927	-0.09	Yes
1	B	5.7760	5.6562	30.5	0.926	0.11	Yes
1	C	5.7685	5.6486	30.5	0.926	-0.02	Yes
2	A	5.5757	5.4601	30.5	0.928	-0.09	Yes
2	B	5.5866	5.4708	30.5	0.928	0.10	Yes
2	C	5.5799	5.4644	30.5	0.928	-0.01	Yes

Figure 52: Winding resistance table results view

10.3 Winding Resistance Interval

With interval measurement, it is possible to measure the winding resistance as a function of time. Figure 53 shows the measurement view and following that each part is explained.

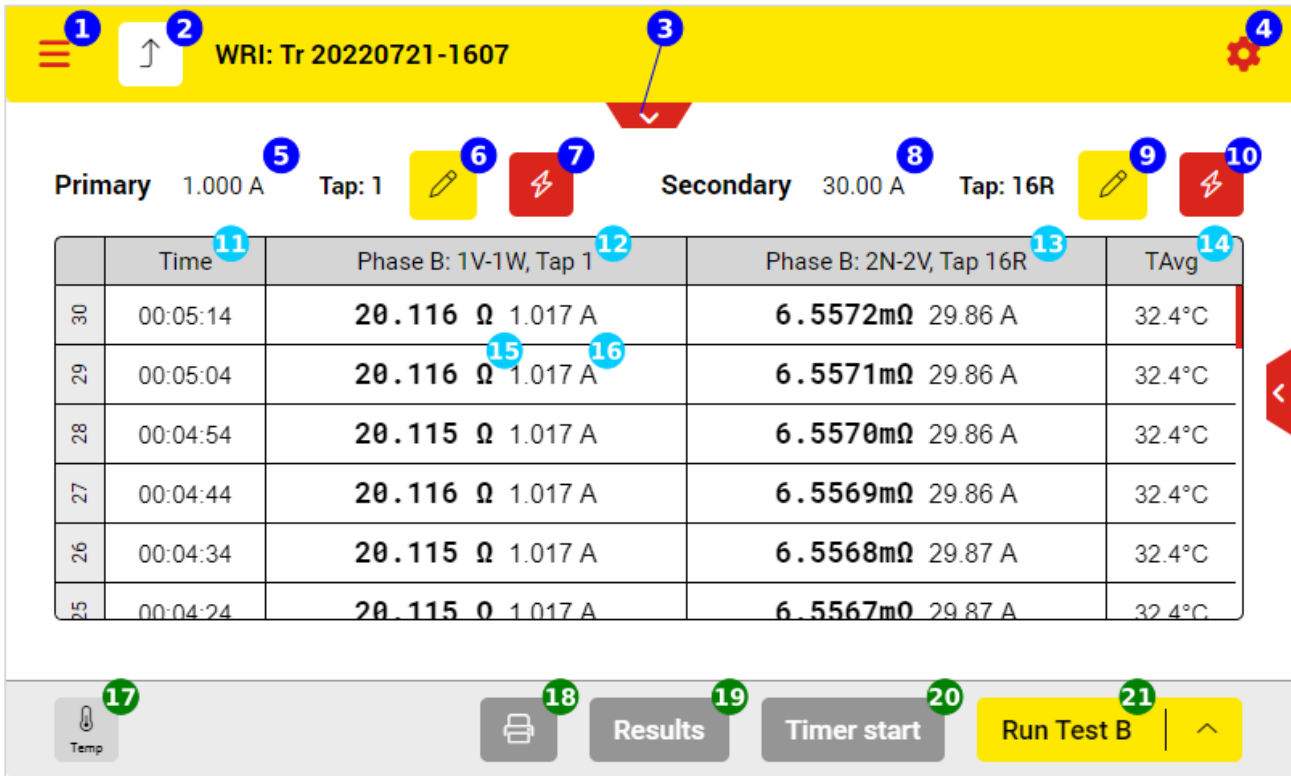

Figure 53: Winding Resistance Interval measurement view

- | | |
|-------------------------------------------------------------------------------------------------------------------------------------------------------------------------------------------------------------------------------------------------------------------------|-------------------------------------------------------------------------------------------------------------------------------------------------|
| 1 Open the main menu | 11 Elapsed time |
| 2 Back to the test plan page | 12 The phase and the corresponding connections which be used automatically by the instrument to test each side and also the tap position |
| 3 Open test object quick access | 13 The average of measured and external temperatures |
| 4 Test settings | 14 The measured resistance |
| 5 The selected current that injects into the primary winding side | 15 The actual test current |
| 6 The actual tap position of primary side | 16 To see the actual measurement value of each temperature measurement channel |
| 7 To turn On or turn Off the power supply for the primary side. It is also possible to select "Charge" mode. In charge mode, the power supply injects current to the primary side to increase the transformer charging speed. But no resistance will be measured | 17 Print results by using the thermal printer |
| 8 The selected current that injects into the Secondary winding side | 18 Open the detailed results in table view or graphs |
| 9 The actual tap position of secondary side | 19 To start the timer separately. When you run the test without starting the timer before, the timer will automatically also start. |
| 10 To turn On or turn Off the power supply for the secondary side | 20 Start test button |
| | 21 |

The winding resistance interval measurement view during the test is shown in and following it, important parts are explained.

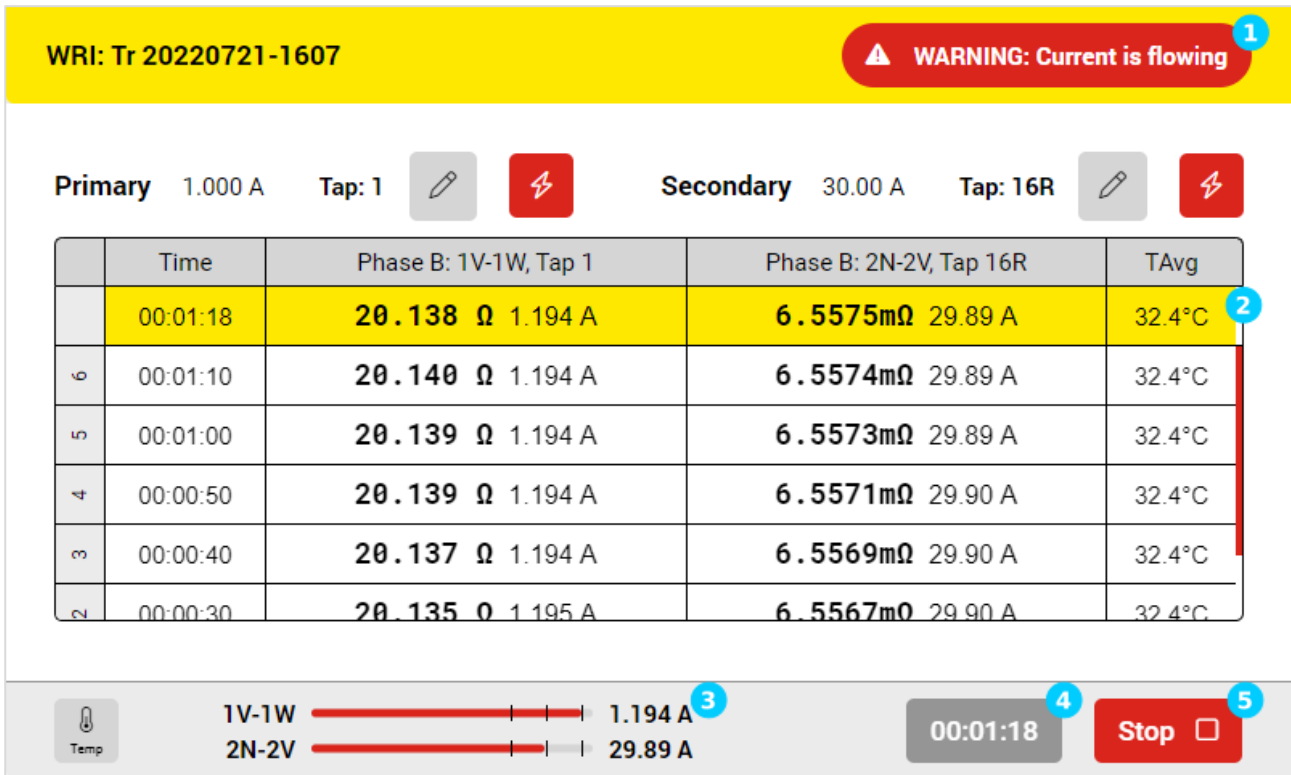

Figure 54: Winding resistance interval measurement view during the test

- 1 The warning symbol shows that it is not safe to touch the cables and test clamps
- 2 The highlighted row shows the actual parameters value
- 3 The output current bars show what is the actual value of output current for each channel and which terminals are used to inject the currents.
- 4 The actual elapsed time
- 5 The stop button can be used to stop the test. Please note that it takes time to discharge and stop the test



WARNING!

After measurement stop, it takes time to discharge the test object! Wait until the device mode changes to safe mode before any other action!

10.3.1 Winding Resistance Interval Settings

Figure 55 shows the winding resistance interval main settings.

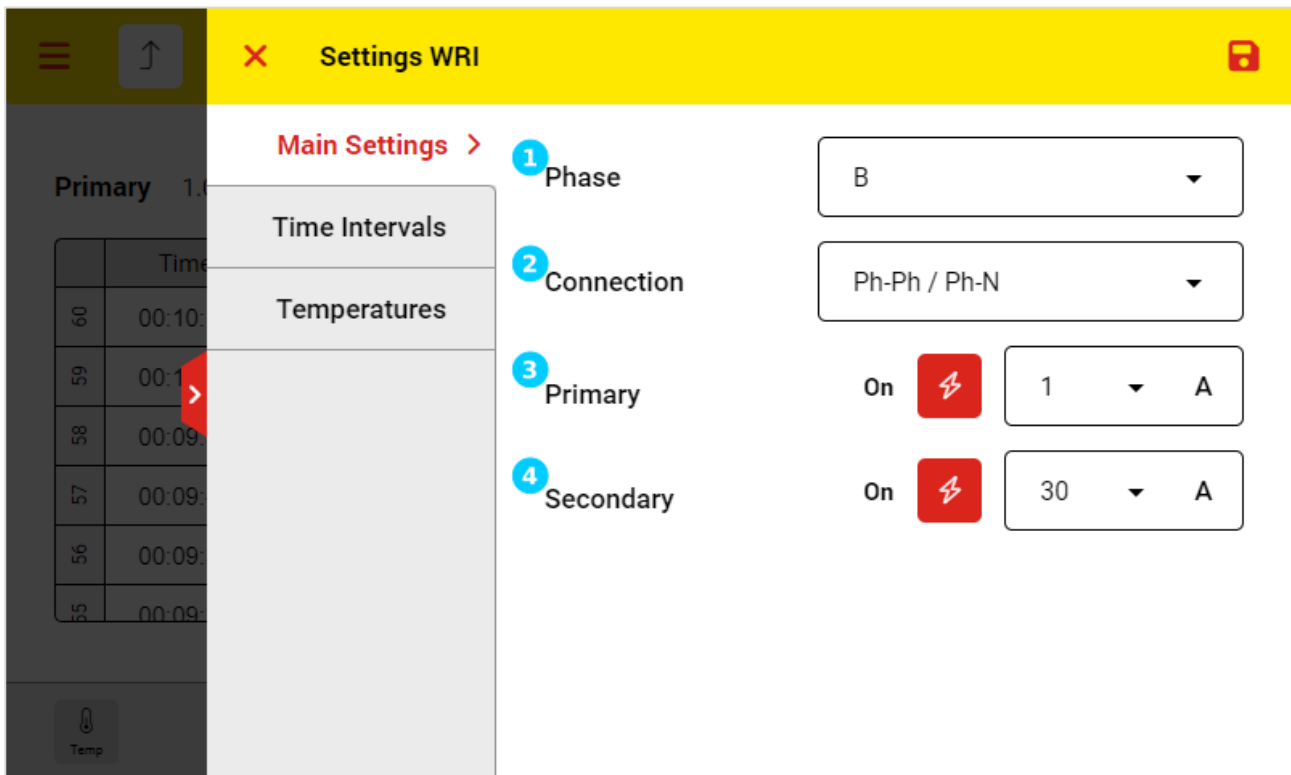

Figure 55: Winding resistance interval main settings

- 1 To select which phase to test
- 2 To select test phase to phase or phase to neutral measurement when possible
- 3 To select the current that injects into the primary winding side and also to turn On or turn Off the power supply for the primary side. It is also possible to select "Charge" mode. In charge mode, the power supply injects current to the primary side to increase the transformer charging speed. But no resistance will be measured
- 4 To select the current that injects into the secondary winding side and also to turn On or turn Off the power supply for the secondary side

Figure 56 shows the time intervals settings.

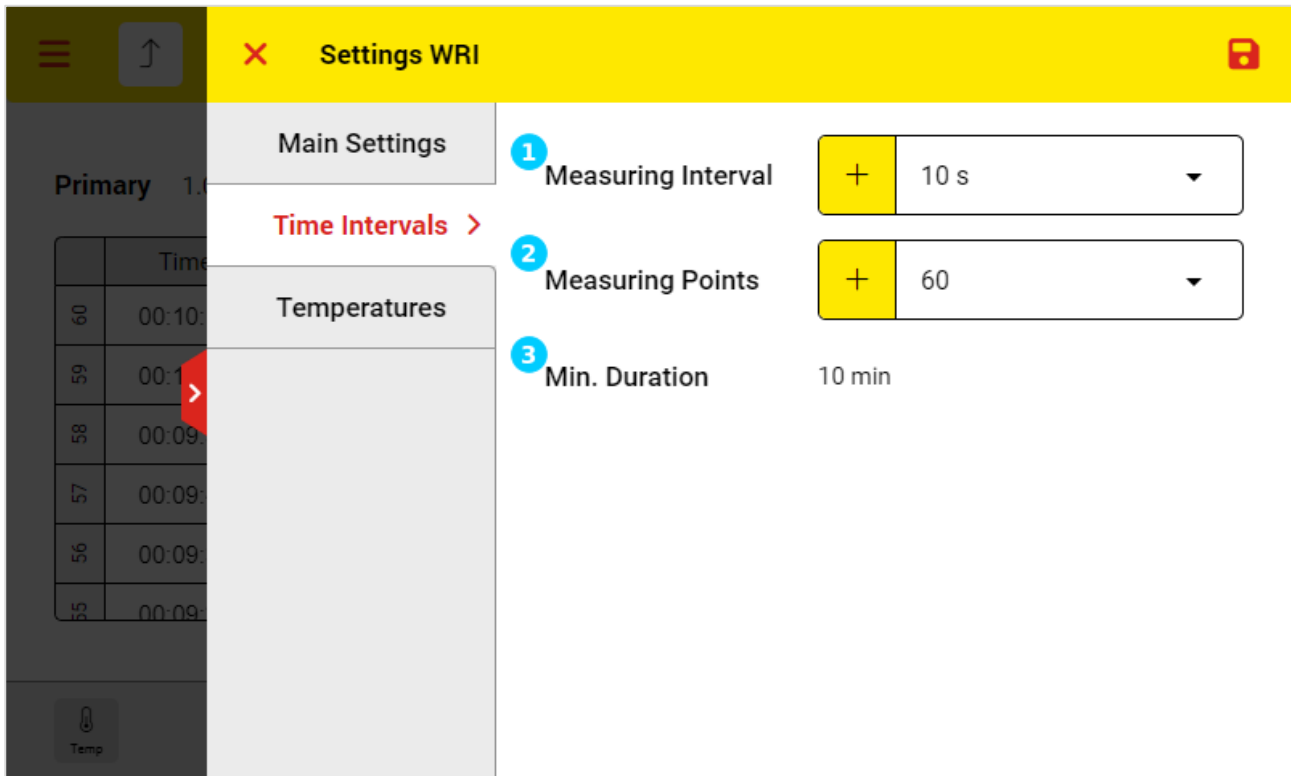

Figure 56: Winding resistance interval, time intervals settings

- 1 To set the time duration between each two measurement points

- 2 To set the number of measuring points

- 3 Total measurement duration which is calculated by timing measuring interval and measuring points

The temperature settings of the winding resistance interval are the same as winding resistance settings. Please see chapter 10.2.2, Temperature settings part, to see the explanation.

10.3.2 Winding Resistance Interval Result View

By tapping the Results button in the measurement view, the result view will be opened. Result view includes graphs and table. Figure 57 shows the Primary winding resistance graph view. From the drop-down list on top right, it is possible to select also other graphs.

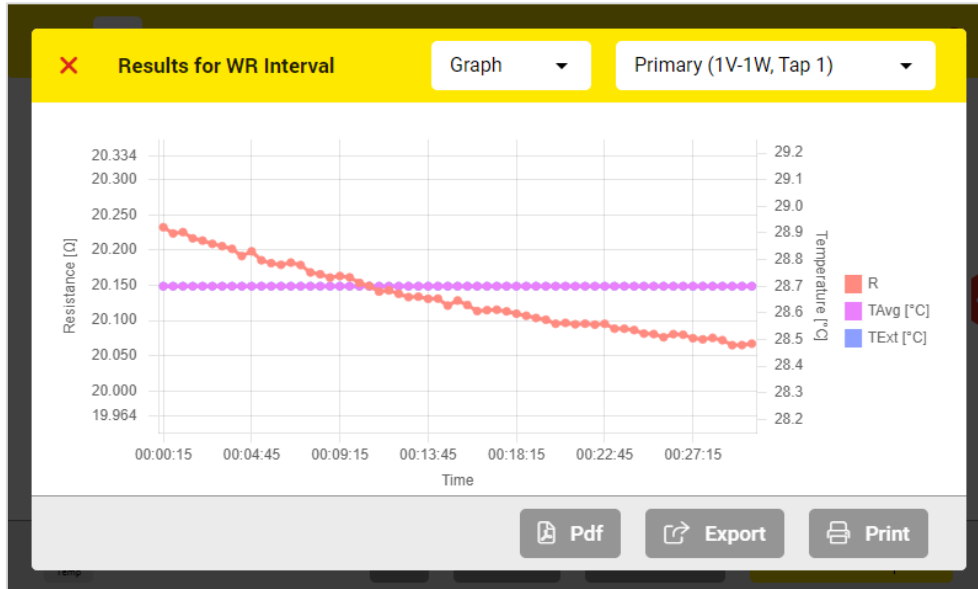
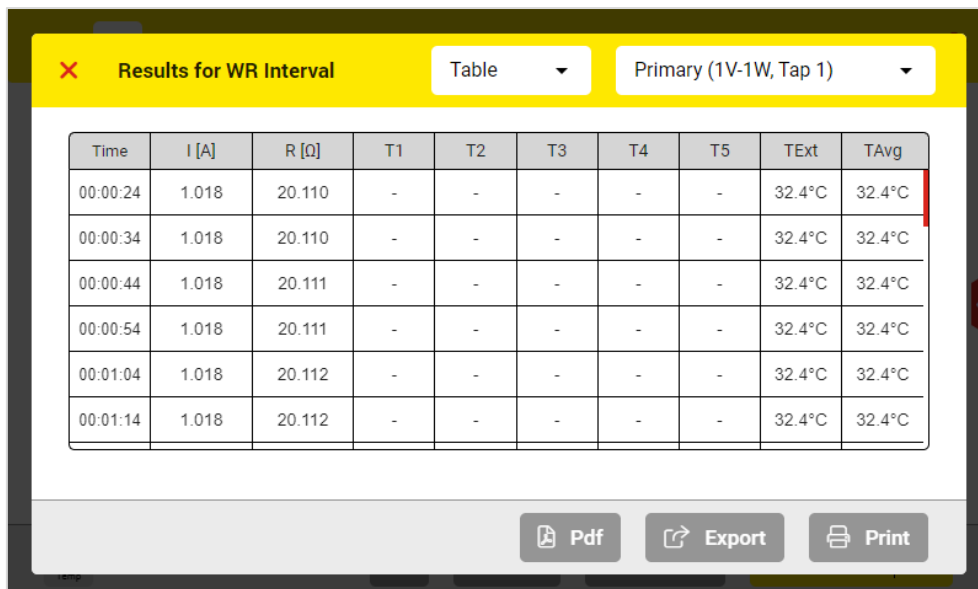

Figure 57: Winding resistance interval graph results view

Figure 58 shows also the Primary table results.



Time	I [A]	R [Ω]	T1	T2	T3	T4	T5	TExt	Tavg
00:00:24	1.018	20.110	-	-	-	-	-	32.4°C	32.4°C
00:00:34	1.018	20.110	-	-	-	-	-	32.4°C	32.4°C
00:00:44	1.018	20.111	-	-	-	-	-	32.4°C	32.4°C
00:00:54	1.018	20.111	-	-	-	-	-	32.4°C	32.4°C
00:01:04	1.018	20.112	-	-	-	-	-	32.4°C	32.4°C
00:01:14	1.018	20.112	-	-	-	-	-	32.4°C	32.4°C

Figure 58: Winding resistance interval table results view

10.4 Demagnetization

Figure 59 shows the demagnetization view and Figure 60 shows the demagnetization view during the test and following each one, the important parts are explained.

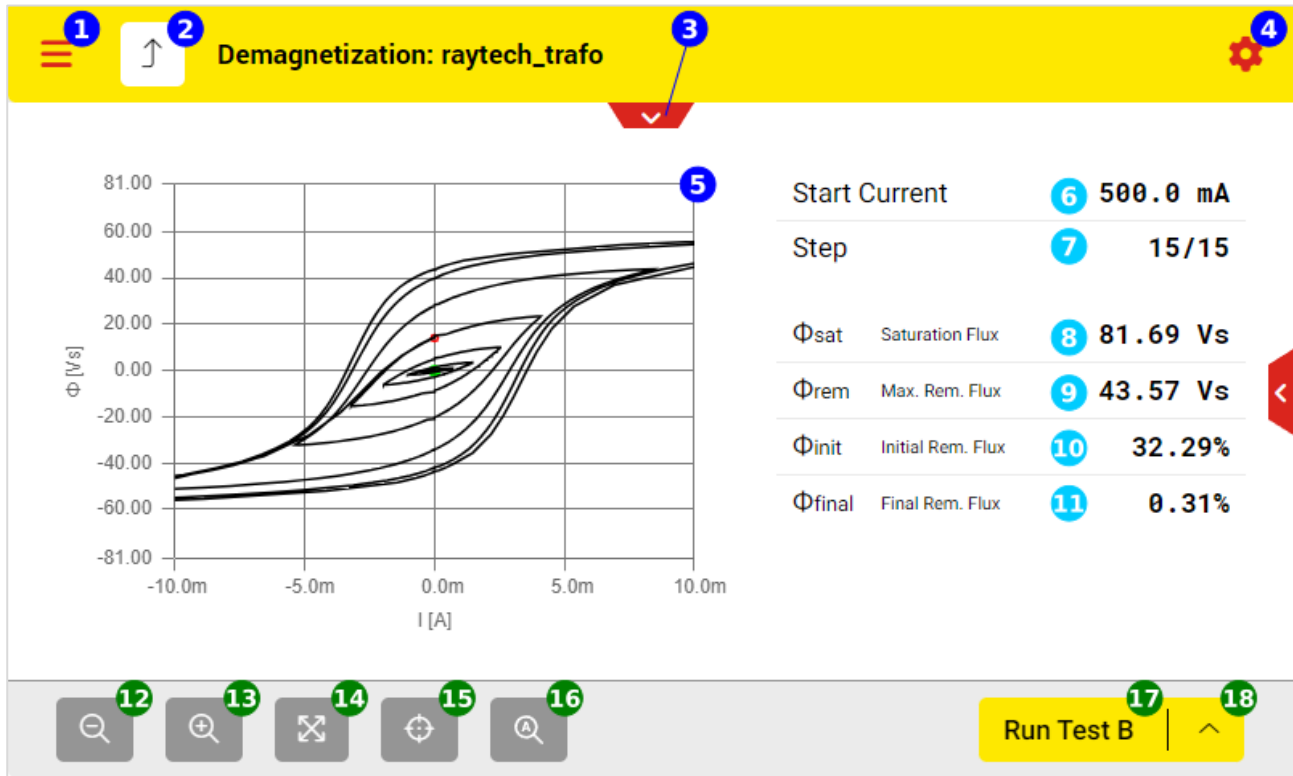

Figure 59: Demagnetization view

(1) Open the main menu	(11) The measured final remanence flux in % (as the percentage of the measured maximum remanence flux)
(2) Back to the test plan page	(12) Zoom out
(3) Open test object quick access	(13) Zoom in
(4) Test settings	(14) Maximize the graph view
(5) The demagnetization curve (Zoomable with two fingers)	(15) Centre the graph view
(6) The adjusted start current that injects into the primary winding	(16) Automatic adaptive graph view
(7) Number of cycles already performed from all cycles	(17) The button to run the test
(8) The measured saturation flux	(18) Test mode to select which phase to perform the demagnetization
(9) The measured maximum remanence flux	
(10) The measured initial remanence flux in % (as the percentage of the measured maximum remanence flux)	

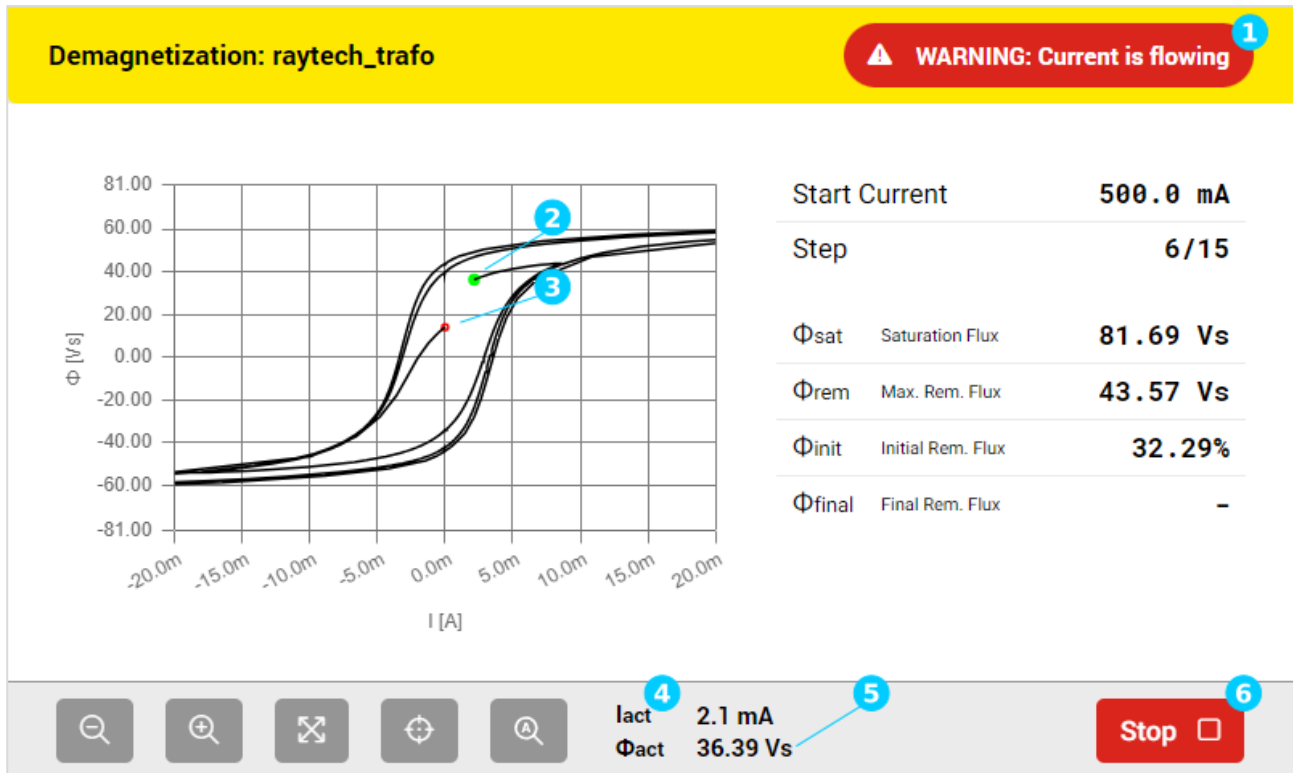

Figure 60: Demagnetization view during the test

- 1 The warning symbol shows that it is not safe to touch the cables and test clamps
- 2 The actual point (the actual flux and the actual current) of the demagnetization curve marked in green
- 3 The first point (initial remanence flux) of the demagnetization curve marked in red
- 4 The actual demagnetization current during the measurement
- 5 The actual flux during the measurement
- 6 The stop button can be used to stop the test. Please note that it takes time to discharge and stop the test



WARNING!

After measurement stop, it takes time to discharge the test object! Wait until the device mode changes to safe mode before any other action!

10.4.1 Demagnetization Settings

Figure 61 shows the demagnetization settings.

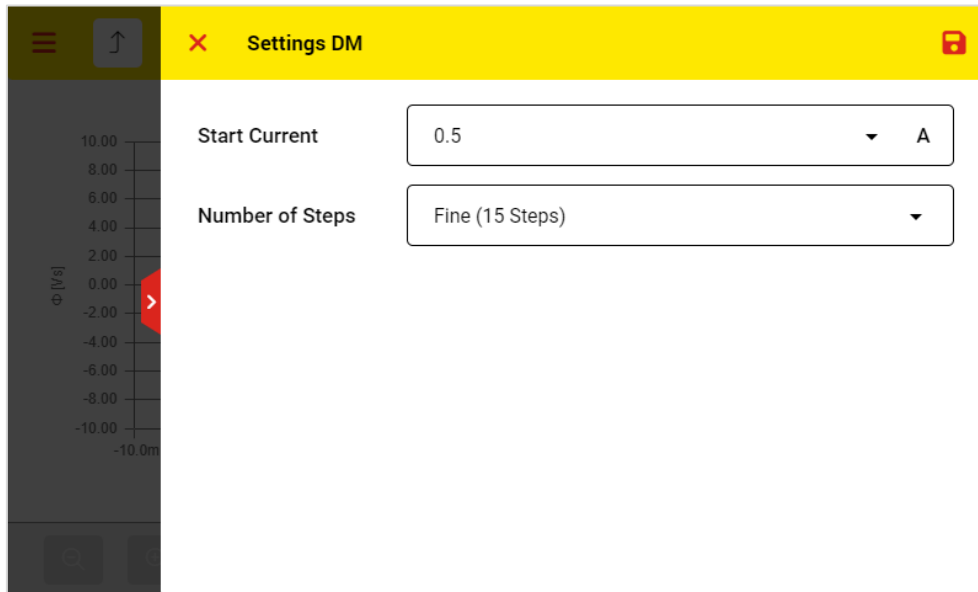

Figure 61: Demagnetization settings

The start current can be selected from 200mA and up to 30A. For currents up to 7.5A, the maximum output voltage is 50VDC (up to 100VDC with the automatic booster). For currents more than 7.5A, the maximum output voltage is 12VDC. If the test object is a large power transformer, the demagnetization will be faster if the currents up to 7.5A will be selected.

The number of steps can be also adjusted from Very Fast (8 Steps) to Very Fine (20 Steps). Normally, to reach a smaller final remanence flux and hence better demagnetization quality, you can select more steps. However, since the mini-ATOS use the Raytech SPP method (See chapter 4.3.1 for more information), the quality of the demagnetization is quite good even when the number of Steps is set to Very Fast (8 Steps).

10.5 Magnetic Balance

Figure 62 shows the measurement view of the Magnetic Balance test and following that each part is explained.

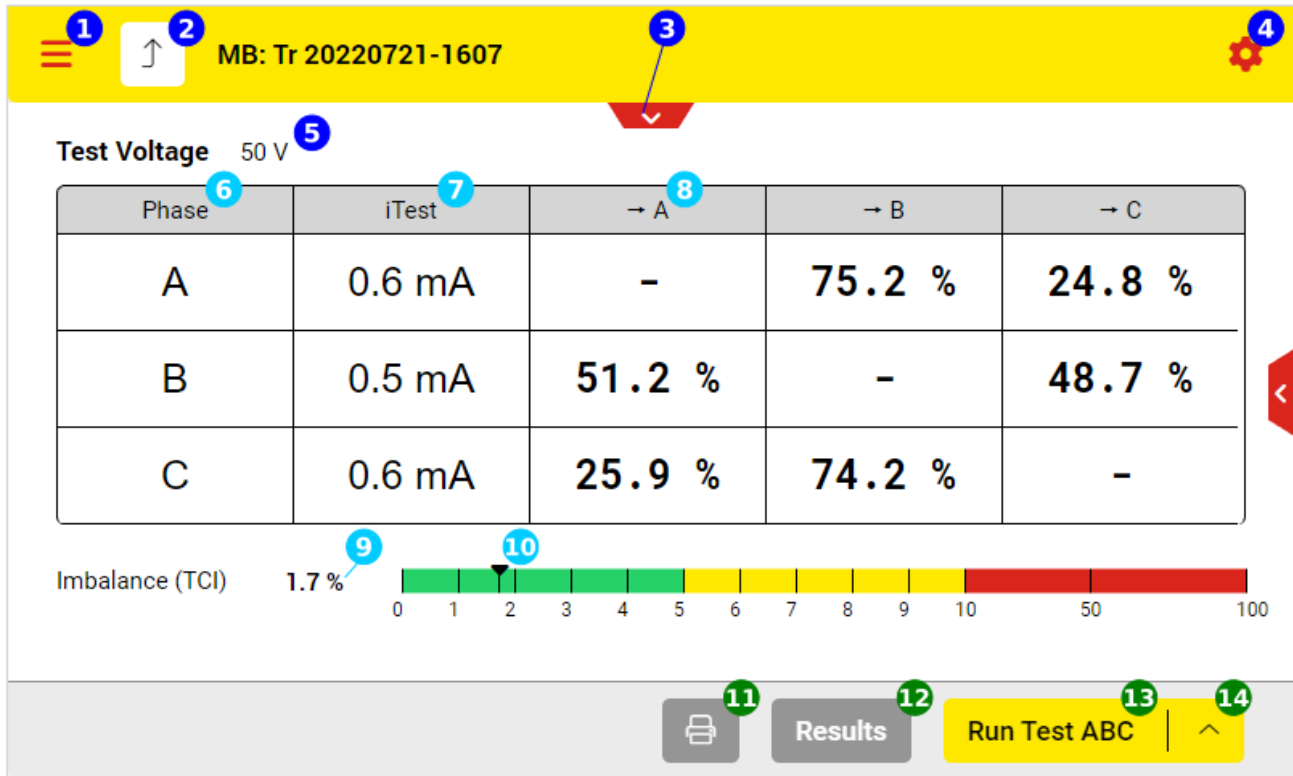

Figure 62: Magnetic Balance measurement view

- | | | | |
|---|--------------------------------------------------------------------------------------------|----|-----------------------------------------------------------------------------|
| 1 | Open the main menu | 9 | The transformer core imbalance value (see chapter 4.4 for more information) |
| 2 | Back to the test plan page | 10 | Showing the TCI value on a colored bar |
| 3 | Open test object quick access | 11 | Print the results by using the thermal printer |
| 4 | Test settings | 12 | Open the detailed results in table view or graphs |
| 5 | The selected test voltage | 13 | Start test button |
| 6 | The Phase which the voltage applied to | 14 | Test mode to select which phase to test (A, B, C, ABC) |
| 7 | The output current during the test | | |
| 8 | The phase which the voltage measured and the values as a percentage of the applied voltage | | |

Figure 63 shows the magnetic balance test during the measurement.

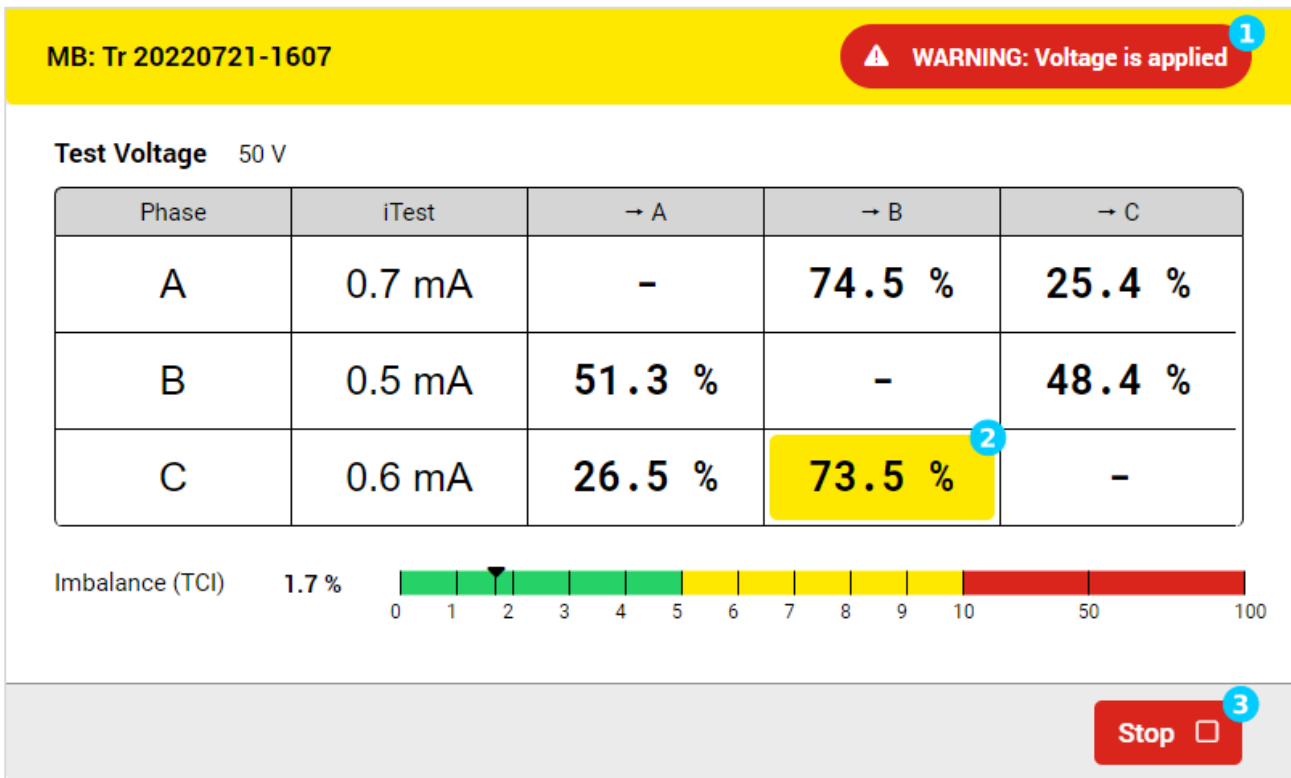

Figure 63: Magnetic balance test during a measurement

- 1 The warning symbol shows that it is not safe to touch the cables and test clamps
- 2 The highlighted cell shows the actual measurement
- 3 The stop button can be used to stop the test. Please note that it takes time to stop the test

10.5.1 Magnetic Balance Settings

Figure 64 represents the magnetic balance measurement settings.

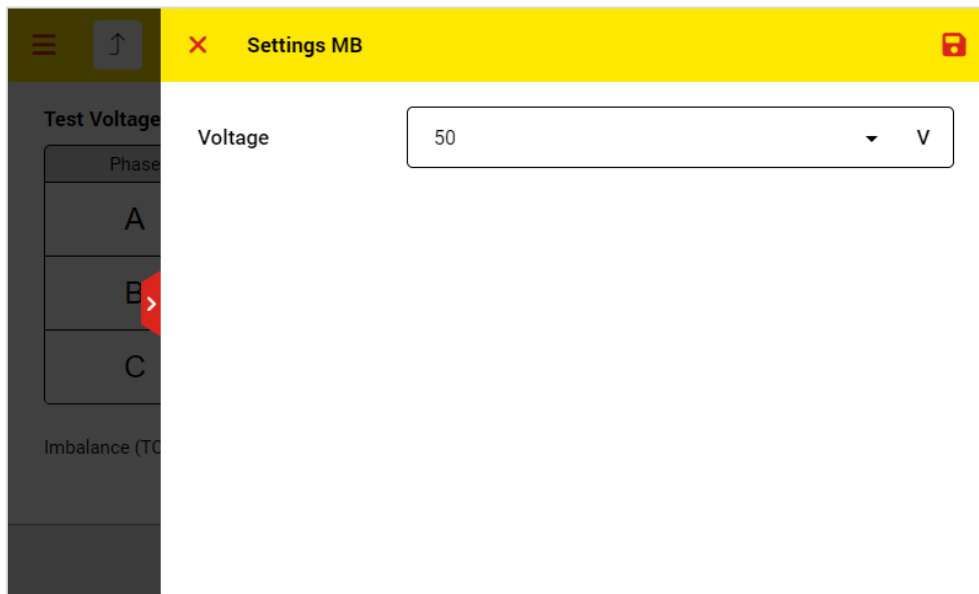

Figure 64: Magnetic balance measurement settings

For magnetic balance, the applying voltage can be selected up to 50VAC. Please note that the test voltage is at 10Hz.

10.5.2 Magnetic Balance Result View

By tapping the Results button in the measurement view, the result view will be opened. Result view includes graphs and table. Figure 65 shows the graph view.

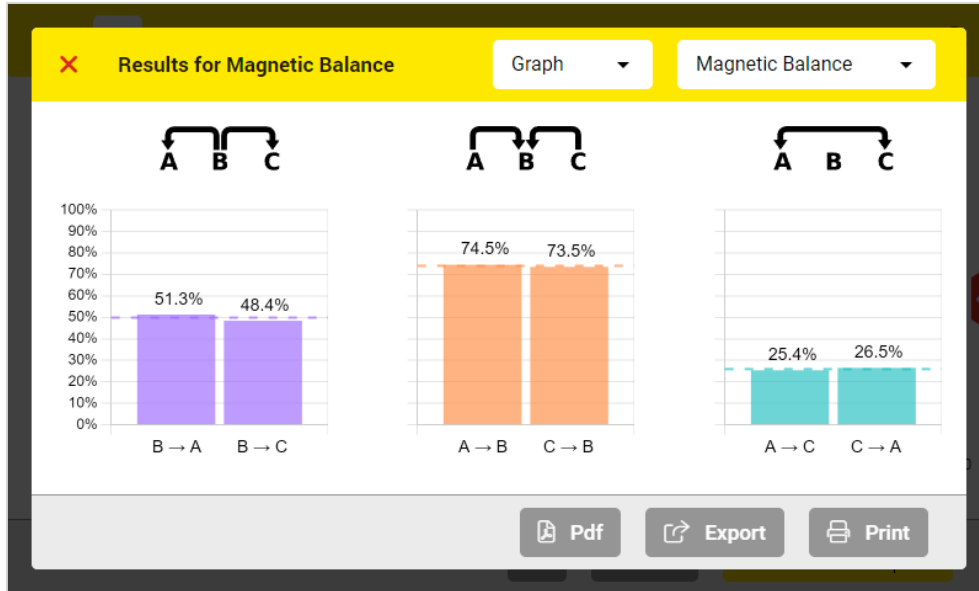

Figure 65: Magnetic balance graph results view

Figure 66 shows also the table results including the colored bar.

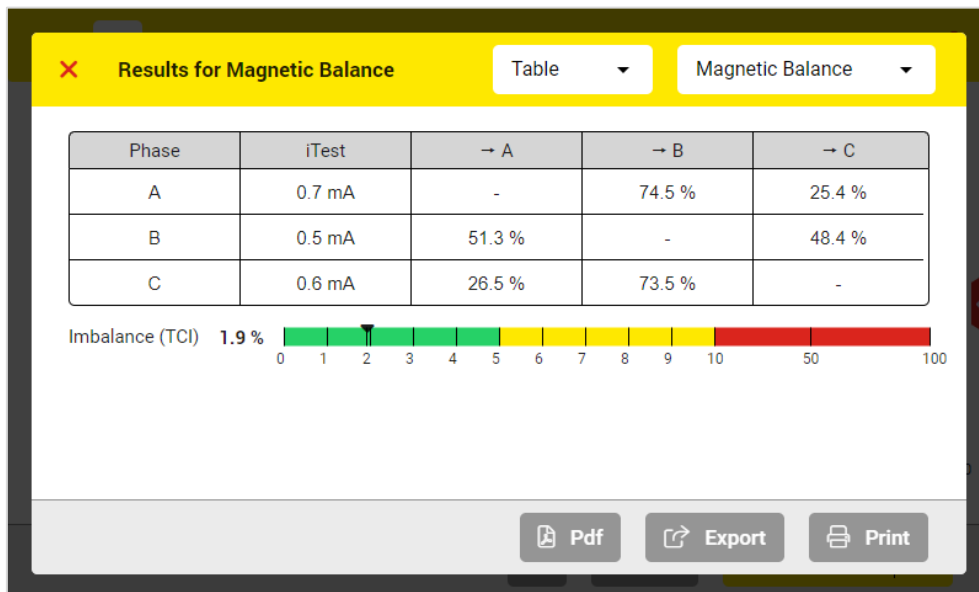

Figure 66: Magnetic balance table results view

11 Go Taps

With go taps, it is possible to perform winding resistance or turns ratio of taps and phases in a sequence of measurements. This helps to measure faster and easier.

To use this option, in the measuring screen and beside the run button, select Run Test Taps from the list of test modes. When you run the test, the Go Taps menu will be first opened as Figure 67. After adjusting the desired parameters, you can start the measurement by using the play icon on the top right of the window.

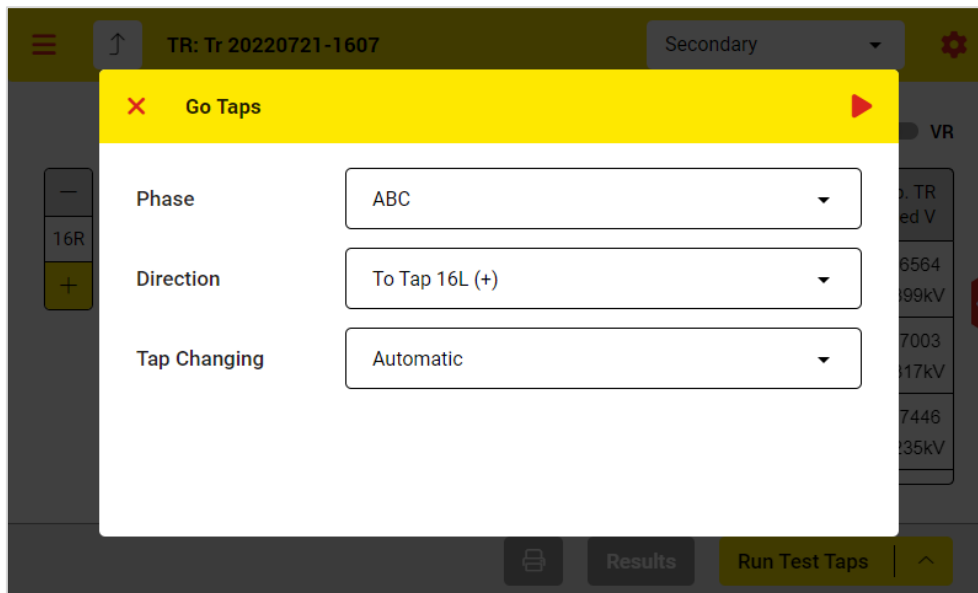

Figure 67: Go Taps menu for turns ratio

Phase

Here, you can select which phase to test. It is possible to test only one phase (e.g. A, B or C), or to test all three phases (ABC) at each tap position. For winding resistance measurement, there is ABC,CBA,ABC,... item which is the optimized three phase version which save time in charge and discharge.

Direction

The tap changing direction should be selected here. You can select either the direction to the first tap or to the last tap.

Tap Changing: Automatic

For automatic tap changing, the mini-ATOS tap control output must be connected to the tap changer control unit for both directions. In the transformer profile, Tap Changer tab also, the tap control must be activated.

During the automatic tap changing, the tap switch window will be shown like Figure 68. In the automatic tap switch window, there is a countdown timer. The system actually waits, so the tap changer has time to change the tap position to the next tap. The waiting period is according to the maximum transition time which was set in the test object profile (Please see chapter 0). After the waiting period, system performs the next measurement.

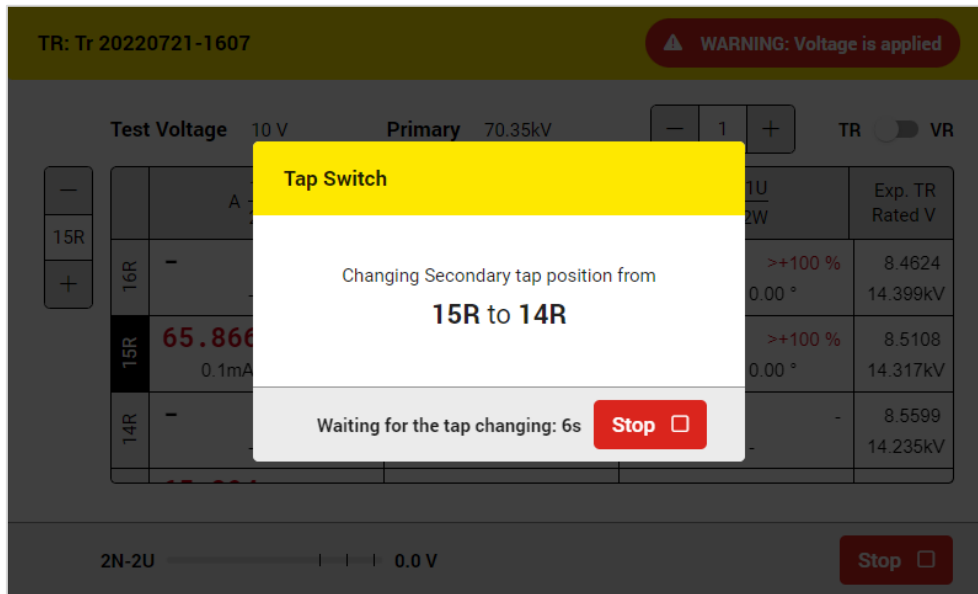

Figure 68: Tap Switch window during automatic tap changing

Tap Changing: Manual

Tap changing can be also manual. During the tap changing, the tap switch window (Figure 69) will ask to change the tap position manually and confirm when it is changed. To confirm, it is possible to tap the confirm button on the screen, and it is also possible to use a hand switch which must be connected to the mini-ATOS External terminal.

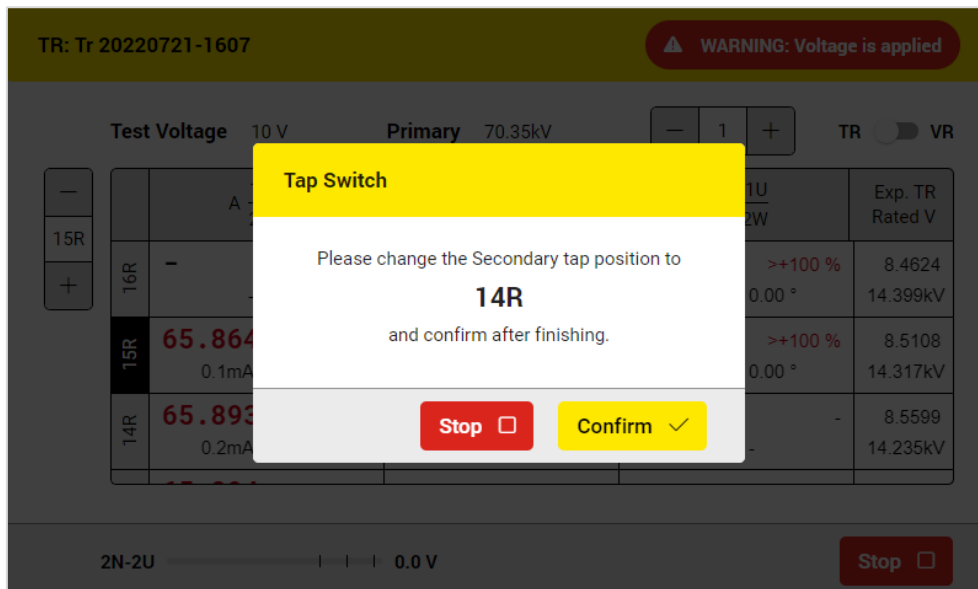



Figure 69: Tap Switch window during manual tap changing

12 Remote Access Instruction

With the remote connection, it is possible to access the device software from other devices such as PC and tablets. The remote connection is possible with the USB or the network connection. When the device is connected, the mini-ATOS can be accessed by using any web browser. For optimal operation, we recommend using Google Chrome or Microsoft Edge browser.

The procedure to use remote access is explained as follows:

- 1- Make sure that Remote access in device settings is enabled (See chapter 7.4.5) and also note what is the access code if it was manually adjusted
- 2- Connect the mini-ATOS to the PC:
 - By using the USB-B cable
 - Or by using the network cable. Make sure that the networking settings are adjusted correctly (Please see chapter 7.4.4)
- 3- From the home page or the main menu, tap the logout icon  to see the select profile page like Figure 70
- 4- Activate remote access on the select profile page. If you didn't input the access key manually in the settings, you will see then the auto-generated access key (Figure 71)
- 5- Open the browser in pc or tablet and then:
 - If the connection is with the USB cable, enter **192.168.11.1** in the address bar to open the software
 - If the connection is with the Network cable, enter the **hostname** (you can find the hostname in the networking settings, please see chapter 7.4.4) after the **http://** (e.g., **http://mini-ATOS-411-101**) in the address bar to open the software
- 6- Enter the access key and confirm to access the software (Figure 72)

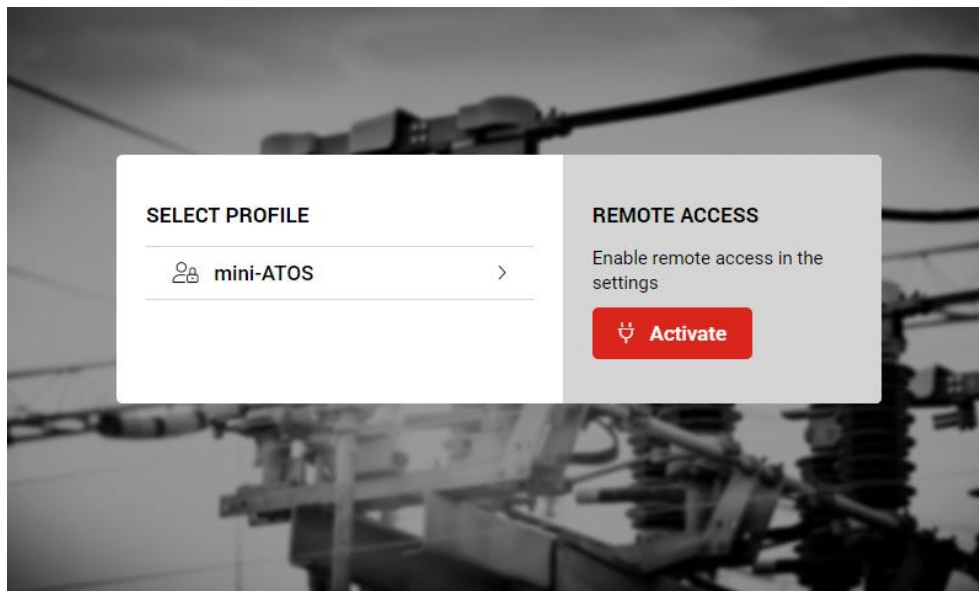

Figure 70: Select Profile page on the mini-ATOS display

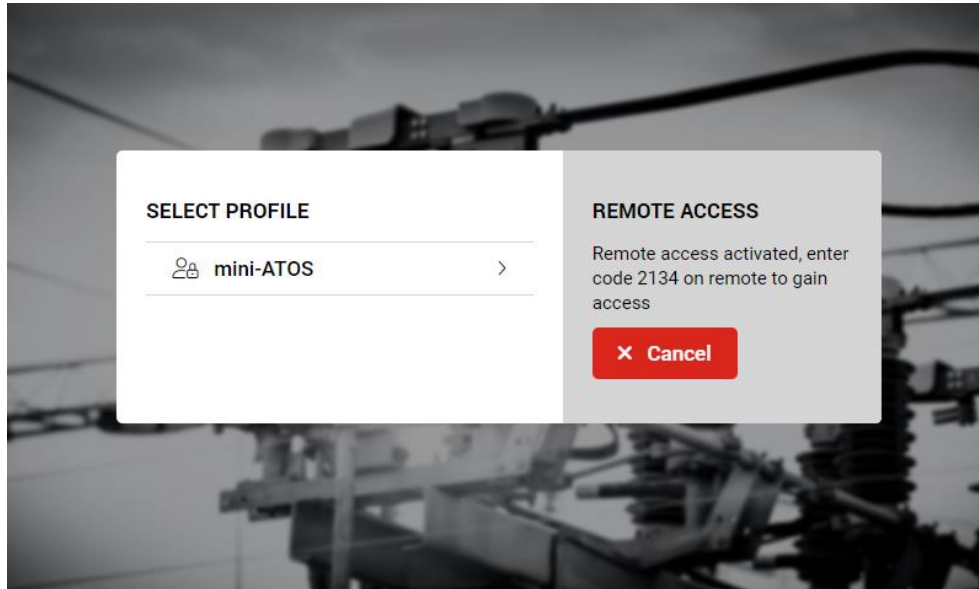

Figure 71: Remote access activated with an auto-generated key on the mini-ATOS display

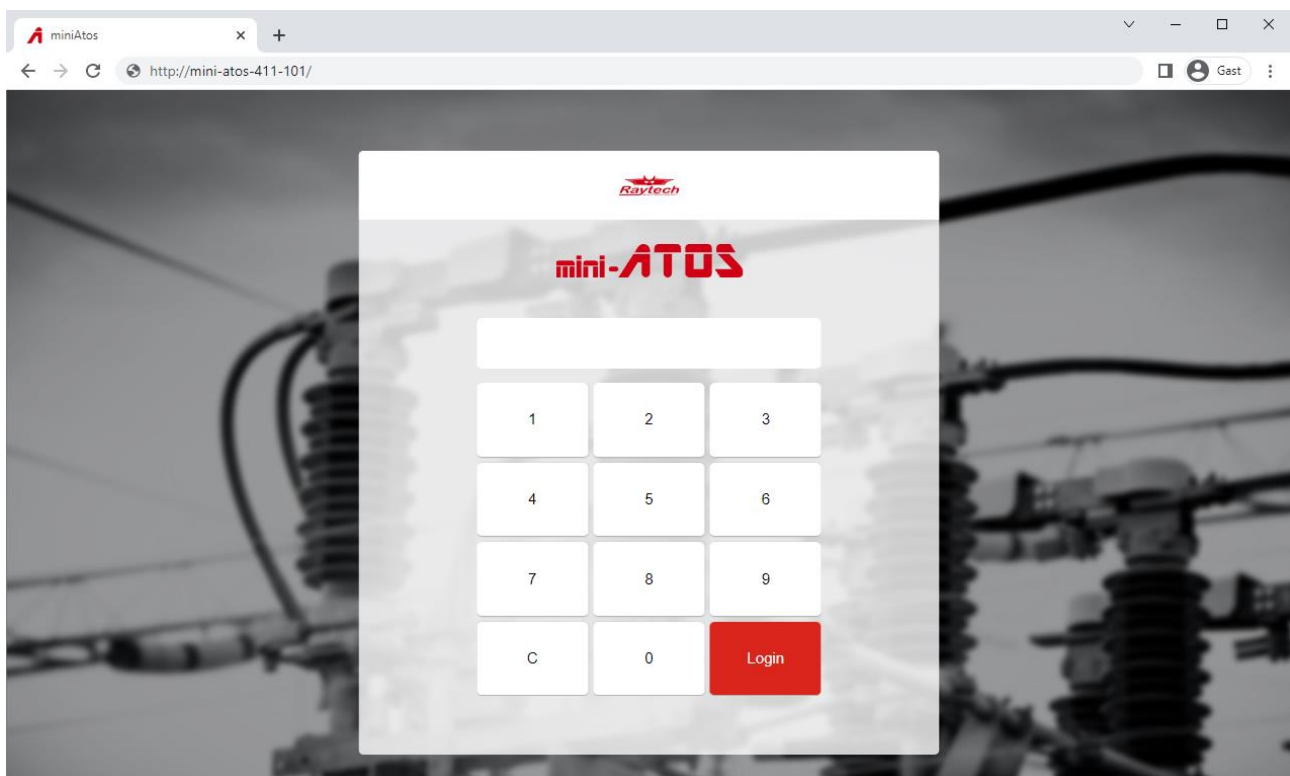

Figure 72: Remote access login page

Notes

- You can always cancel the remote connection from the device
- Only one active session is possible at once
- If the access code is auto-generated, by entering a wrong access code each time, a new code will be generated.

13 Interfaces

13.1 USB

The USB interface consists of two Master connectors and one Slave connector.

The Master connector can be used to update the device and store/load measurement data from USB memory sticks.

It is also possible to connect a USB mouse and a USB keyboard for easier input.

The Slave connector can be used to connect the mini-ATOS to a PC or to connect a USB printer.

USB-Master (Type A) x2

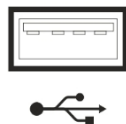

USB-Slave (Type B)



13.2 Ethernet

The Ethernet port can be used to connect the mini-ATOS to a network to enable the remote connection.

RJ45

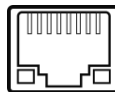

13.3 External (4pins version)

This port is multi-functional and consists of the following functions:

Hand switch for tap changing



Raytech warning lamp



When both hand switch and warning lamp is required then a splitter cable is necessary as follows which can be ordered as an optional item:

Cable adapter hand switch & warning lamp
(4pin to 2x 4pin)



13.4 External (6pins version)

The 6pins external port consists two additional pins to connect an external safety interlock. The function of other 4pins is the same as the 4pins version. The external safety interlock can be for example a safety door or a safety hand switch. The safety interlock must be connected to pin number 5 and 6.

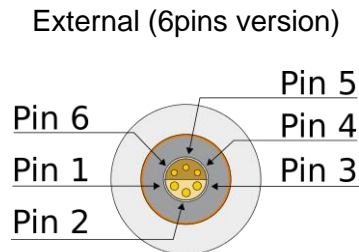

When these pins are shorted, it means that it is safe to perform a measurement. If they are not shorted, it is not possible to start a measurement.

If the connection open during a measurement, measurement will be stopped automatically.

When external safety interlock and either hand switch or warning lamp is required then a splitter cable is necessary as follows which can be ordered as an optional item:

Cable adapter external
(6pin to 6pin & 4pin)



When external safety interlock and both hand switch and warning lamp is required then two splitter cables are necessary as follows which can be ordered as an optional item:

Cable adapter external
(6pin to 6pin & 4pin)



Cable adapter hand switch/ warning lamp
(4pin to 2x 4pin)



13.5 Tap Control

This port is used for an external connection to a tap changer dry contact. With this connection, changing the tap position can be done from the mini-ATOS.



Two connectors are for changing the tap position in up direction and the other two are for changing the tap position in down direction. The cables are marked with labels. The maximum input voltage is 240VAC, Cat II.

14 Technical Specifications

14.1 General

Area of use	Portable to use indoor and outdoor including heavy industrial electromagnetic environments
Enclosure	Industrial high-impact plastic case
Supply	IEC 60320, C13/C14 mains connector, CAT II
Rated input voltages	110/240 VAC @ 50/60Hz, automatic ranging
Absolute input voltages	90-264 VAC @ 47-63Hz
Consumption power	Max. 900VA
Mains protection	2x 5mm x 20mm T10A Fuse
Output power	Max. 600W
Test voltage user selectable (AC)	10,40,100,250 VAC
Max. test current (AC)	1A
Test current user selectable (DC)	0.050-30A and 0.025-7.5A simultaneously
Max. test voltage (DC)	50VDC (100VDC with automatic booster)
Temperature measurement range	-20°C (-4°F) to 110°C (230°F)
Display	7" TFT Color LCD
Input devices	Capacitive touch screen, support mouse and keyboard
Front panel	Sealed, anodized
Interfaces	3 USB 2.0 full speed (2 hosts, 1 device) and Ethernet
Printer	Internal 1.9" thermal printer
Operating temperature	-10°C (14°F) to 55° C (131°F)
Storage temperature	-20°C (-4°F) to 70°C (158°F)
Humidity	5%-95% relative humidity, no condensation
Pollution degree	2
Altitude	Up to 2000m (without derating)
Degree of protection (closed door)	IP67, dust-tight and water immersion up to a 1-meter depth
Degree of protection (open door)	IP20
Size	L: 525 mm (20.7") W: 437 mm (17.2") H: 213 mm (8.4")
Weight (instrument)	16.5 kg (36.4 lbs.)
Weight (accessories)	Please contact
Shipping weight and package size	Please contact

14.2 Accuracies

All accuracies values are measured at an ambient temperature of $23\pm 5^{\circ}\text{C}$ after a warm-up of 30min.

14.2.1 Turns Ratio Measurement

Table 7: Turns ratio accuracy

Parameter	Range	Accuracy	Resolution
Turns Ratio 250VAC @ 55Hz	0.8 ... 200	$\pm 0.04\%$ Rdg ± 1 LSD	5 Digits
	200 ... 5000	$\pm 0.10\%$ Rdg ± 1 LSD	5 Digits
	5000 ... 50000	$\pm 0.40\%$ Rdg ± 1 LSD	5 Digits
Turns Ratio 100VAC @ 55Hz	0.8 ... 200	$\pm 0.04\%$ Rdg ± 1 LSD	5 Digits
	200 ... 5000	$\pm 0.10\%$ Rdg ± 1 LSD	5 Digits
	5000 ... 20000	$\pm 0.40\%$ Rdg ± 1 LSD	5 Digits
Turns Ratio 40VAC @ 55Hz	0.8 ... 200	$\pm 0.04\%$ Rdg ± 1 LSD	5 Digits
	200 ... 5000	$\pm 0.06\%$ Rdg ± 1 LSD	5 Digits
	5000 ... 20000	$\pm 0.40\%$ Rdg ± 1 LSD	5 Digits
Turns Ratio 10VAC @ 55Hz	0.8 ... 200	$\pm 0.06\%$ Rdg ± 1 LSD	5 Digits
	200 ... 5000	$\pm 0.10\%$ Rdg ± 1 LSD	5 Digits

Table 8: Other AC parameters accuracy

Parameter	Range	Accuracy	Resolution
AC Test Current @ 55Hz	0 ... 1 A	$\pm 1.00\%$ Rdg ± 0.01 A	4 Digits
Phase Angle @ 55Hz	$\pm 90^{\circ}$	$\pm 0.05^{\circ}$ Rdg ± 1 LSD	4 Digits or 0.01°
Output Voltage	0 – 250VAC	$\pm 1\%$ ± 1 LSD	4 Digits or 0.1VAC

14.2.2 Resistance Measurements

Table 9: DC resistance accuracies with 50V/7.5A DC power supply

I_{test}	Range	Accuracy	Resolution
5.0 - 7.5A	0.00 $\mu\Omega$... 10 Ω	$\pm 0.10\%$ Rdg $\pm 1.6\mu\Omega$	5 Digits or 0.01 $\mu\Omega$
1.0 – 5.0A	0.00 $\mu\Omega$... 50 Ω	$\pm 0.10\%$ Rdg $\pm 8.0\mu\Omega$	5 Digits
0.5 – 1.0A	0.00 $\mu\Omega$... 100 Ω	$\pm 0.10\%$ Rdg $\pm 16\mu\Omega$	5 Digits
0.1 - 0.5A	0.00 $\mu\Omega$... 500 Ω	$\pm 0.10\%$ Rdg $\pm 80\mu\Omega$	5 Digits
25 - 100mA	0.00 $\mu\Omega$... 2k Ω	$\pm 0.10\%$ Rdg $\pm 320m\Omega$	5 Digits
< 25mA	2k Ω ... 10k Ω	$\pm 0.10\%$ Rdg $\pm 50\Omega$	5 Digits
< 25mA	10k Ω ... 100k Ω	$\pm 1\%$ Rdg $\pm 500\Omega$	5 Digits

Table 10: DC resistance accuracies with 12V/30A DC power supply



I_{test}	Range	Accuracy	Resolution
25.0 – 30.0A	0.00 $\mu\Omega$... 0.48 Ω	$\pm 0.10\%$ Rdg $\pm 0.4\mu\Omega$	5 Digits or 0.01 $\mu\Omega$
20.0 – 25.0A	200 $\mu\Omega$... 0.60 Ω	$\pm 0.10\%$ Rdg $\pm 0.1\mu\Omega$	5 Digits
20.0 – 25.0A	0.00 $\mu\Omega$... 200 $\mu\Omega$	$\pm 0.10\%$ Rdg $\pm 0.3\mu\Omega$	5 Digits
15.0 – 20.0A	0.00 $\mu\Omega$... 0.80 Ω	$\pm 0.10\%$ Rdg $\pm 0.6\mu\Omega$	5 Digits
10.0 – 15.0A	0.00 $\mu\Omega$... 1.2 Ω	$\pm 0.10\%$ Rdg $\pm 0.8\mu\Omega$	5 Digits
5.0 – 10.0A	0.00 $\mu\Omega$... 2.4 Ω	$\pm 0.10\%$ Rdg $\pm 1.6\mu\Omega$	5 Digits
1.0 – 5.0A	0.00 $\mu\Omega$... 12 Ω	$\pm 0.10\%$ Rdg $\pm 8.0\mu\Omega$	5 Digits
0.5 – 1.0A	0.00 $\mu\Omega$... 24 Ω	$\pm 0.10\%$ Rdg $\pm 16\mu\Omega$	5 Digits
0.1 - 0.5A	0.00 $\mu\Omega$... 120 Ω	$\pm 0.10\%$ Rdg $\pm 80\mu\Omega$	5 Digits
50 - 100mA	0.00 $\mu\Omega$... 240 Ω	$\pm 0.10\%$ Rdg $\pm 1.2\Omega$	5 Digits
< 50mA	240 Ω ... 1k Ω	$\pm 0.10\%$ Rdg $\pm 5\Omega$	5 Digits
< 50mA	1k Ω ... 10k Ω	$\pm 1\%$ Rdg $\pm 50\Omega$	5 Digits

14.2.3 Temperature Measurement

Table 11: Output voltage accuracy

Range	Accuracy	Resolution
0 – 70°C	$\pm 0.2^\circ\text{C} \pm 1 \text{ LSD}$	0.1°C

14.3 Standards and Approvals

 	Safety			IEC 61010-1
	EMC	Emission Class A	RF emission	CISPR 11
			Current harmonic emission	IEC 61000-3-2
			Flicker and voltage fluctuations	IEC 61000-3-3
		Immunity industrial electromagnetic environment	Electrostatic discharge (ESD)	IEC 61000-4-2
			Electromagnetic field	IEC 61000-4-3
			Burst	IEC 61000-4-4
			Surge	IEC 61000-4-5
			Conducted RF	IEC 61000-4-6
			Power frequency magnetic field	IEC 61000-4-8
	Voltage dip	IEC 61000-4-11		



Appendix

mini-ATOS

mini Automatic Transformer
Observation System

Appendix

A	Warranty Conditions.....	86
A.1	Limitation of Warranty	86
A.2	Arbitration.....	87
B	Maintenance.....	88
B.1	Instrument Cleaning Instruction.....	88
B.2	How to Insert Paper into Thermal Printer.....	88
B.3	Thermal Printer Cleaning Instruction	89
C	Index	90
D	Contacts.....	92

A Warranty Conditions

Raytech AG Switzerland shall at their option and expense, repair or replace any part or parts that prove to be defective within the warranty limitation period- irrespective of the operating time of the test equipment provided that the cause of the defect occurred before the time at which the risk was passed.

Warranty claims are subject to a warranty limitation period of 24 months from the date of shipment.

The purchaser is obligated to immediately notify Raytech AG Switzerland in writing of any defects of the supplied test equipment.

Raytech AG Switzerland must always be allowed to rectify a defect within a reasonable amount of time. The purchaser shall grant an adequate amount of time that the test equipment shall be repaired.

Raytech AG Switzerland covers the costs associated with the repair of the defect; especially the costs for the material and work. The cost for sending the faulty test equipment shall be borne by the purchaser. Raytech AG Switzerland shall not be liable for material damage, or financial loss due to the loss of production, loss of data, loss of information, data or interest, regardless of their legal basis.

Warranty claim rights on replacement parts as well as repair of defective parts shall expire after 12 months.

The warranty limitation period shall be extendable according to the price list. The purchaser has the right to extend the warranty period by purchasing additional warranty years.

A.1 Limitation of Warranty

The foregoing warranty shall not apply to defects resulting from:

- Improper and unauthorized modifications or misuse and abuse of the product, negligence, alteration, modification, faulty installation by the customer, customer's agents or employees.
- Attempted or actual dismantling, disassembling, service or repair by any person, firm, or corporation not specifically authorized in writing by Raytech AG Switzerland.
- Defects caused by or due to handling by the carrier, or incurred during shipment, transshipment, or other moves.
- Inadequate maintenance by the customer, the second source supplied software or interfacing, operation outside the environmental limits, or improper site preparation.

Exclusive remedies provided herein are the customer's sole and exclusive remedies.

Raytech Switzerland shall not be liable for any damages resulting from the use of this equipment whether direct, indirect, special, incidental, or consequential damages, or whether based on contract, tort, or any other legal theory.



INFO:

NO OTHER WARRANTY IS EXPRESSED OR IMPLIED.

A.2 Arbitration

All disputes arising out of or in connection with the contract between the purchaser and Raytech AG Switzerland and including those regarding the legal validity of this contract and this arbitration clause shall be settled out of court and shall be referred to arbitration for final decision.

B Maintenance

B.1 Instrument Cleaning Instruction

- Before the cleaning, disconnect the device from the Mains circuit.
- Use only lint-free cloth for the cleaning and when required slightly dampened with water.
- Never spray cleaners directly on the front panel. You can spray cleaners directly on the outer surface of the case only when the door is closed completely.
- Never use cleaning solutions that contain bleach or abrasives.

B.2 How to Insert Paper into Thermal Printer



- Open the paper tray by slightly pulling the lever upwards. The paper tray can now easily be opened.



- On the paper roll, the printable side is the outside of the paper roll.
- Unwind a few cm (inch) of paper from the roll.
- Keep the layers wound tightly when inserting the paper roll into the paper tray. The paper outside shows towards the printer mechanism.



- Close the paper tray by applying strong pressure.
- You can hear it snap shut. Now the paper can be torn off at the tear-off edge without opening the paper tray again nor the paper sliding through the printer mechanism.

B.3 Thermal Printer Cleaning instruction



- Open the paper tray and remove the paper roll.
- Do not touch the print head as it may be damaged by static electricity.
- Loosen dirt particles at paper, sensor and tear bar with a small brush.
- Forcefully blow into the paper tray to remove the coarse dust.
- Soak Q-tip with isopropanol (IPA) and clean the sensor, platen roll and print head rail, as well as further dirt.
- Other strong contaminations may also be removed with a Q-tip soaked with isopropanol (IPA).

C Index

Access code	30
Archive	25
Auto detect voltage.....	52
autodetect.....	37
Cleaning instruction	86
CSV separator.....	28
Date and time.....	28
DC resistance accuracies	80
DC resistance test.....	13
Decimal separator	28
Demagnetization	16
Demagnetization view	65
Dual supply mode	56
Emergency stop.....	23
Export logs.....	31
First/Last method.....	43
Fuse	22
Go taps	72
Home screen	24
H-Side current	57
Humidity.....	78
Inspections	26
Labels wizard.....	45
Language	28
Temperature unit	28
License.....	32
Max error	52
Maximum acceptable deviation.....	57
Nameplate.....	38
Naming scheme.....	29
Networking.....	29
Number of steps.....	67
Operating temperature.....	78
Rated voltages wizard	43
Reference temperature.....	40
RefTap/Step method.....	44
Relative error	12
Remote access instruction	74
Resistance deviation	15
Safety indicators.....	22
Safety precautions	5
Service codes.....	31
Smart pattern predictor	17
Software update.....	31
SPP method	17
Stability condition	57
Standards and approvals.....	81
Start current.....	67

Storage temperature.....	78
Temperature coefficient	40
Temperature correction.....	14
Templates.....	27
Test plan.....	46
Test voltage	52
Thermal printer cleaning.....	87
Turns ratio.....	10
Turns ratio accuracy.....	79
Turns ratio measurement	10
Turns ratio measurement view	49
Unsafe area	7
Voltage ratio.....	10
Winding configuration autodetect.....	37
Winding resistance measurement view	54
X-Side current.....	57

D Contacts

Raytech Switzerland

Raytech AG
Oberbenenstrasse 11
5620 Bremgarten

Phone: +41 56 648 6010
Fax: +41 56 648 6011

Mail: welcome@raytech.ch
Web: www.ravtech.ch

Your local representative

